

GENERAL
SEMICONDUCTOR
INDUSTRIES, INC.

GENERAL SEMICONDUCTOR INDUSTRIES INC. DIODE AND TRANSISTOR PRODUCT CATALOG

This catalog contains a complete listing of discrete devices manufactured by General Semiconductor Industries, Inc.

A product listing of both JEDEC and General Semiconductor type numbers are shown in the front of each product section. This catalog is designed to supply the user with pertinent data on zener and reference diodes and power switching transistors. Complete device characterization is also supplied on General Semiconductor's TransZorb® (silicon transient voltage suppressor) and C²R® (high speed, high voltage switching transistor).

HOW TO USE THIS CATALOG:

Devices are listed numerically within specific categories enumerated in the Table of Contents.

TransZorbs are listed by the JEDEC types first followed by power capability then specific applications, and diodes by steady state power ratings. Transistors are categorized by continuous collector current rating.

If a JEDEC device type is not shown in the catalog, check the JEDEC Recommended Replacement Index.

HOW TO ORDER:

All devices in this catalog are available through your local distributor. For special device selection, consult your General Semiconductor sales representative,
or

General Semiconductor Industries, Inc.
P.O. Box 3078
2001 West Tenth Place
Tempe, Arizona 85281
Phone (602) 968-3101
TWX 910 — 950-1942

TABLE OF CONTENTS

Numerical Index — Diodes	i
Numerical Index — Transistors	xii
Available JEDEC Types or Suggested Replacements Index — Diodes	xv
Available JEDEC Types or Suggested Replacements Index — Transistors	xxxii

Section 1 — TransZorbs®

TransZorb Definition & Specifications	1-1
1.5KW, Metal	1-3
1.5KW, Molded	1-11
1.5KW, Leadless	1-13
5KW, Molded	1-15
15KW, Assembly	1-17
500W, Low Voltage	1-23
1.5KW, IC	1-25
Low Capacitance, Metal	1-33
Low Capacitance, Molded	1-35
1.5KW, Microprocessor	1-37
600W Molded	1-45
15KW Bidirectional Assembly	1-47
500W, Molded	1-49
Signal line Surge Suppressor	1-51
Low Capacitance Signal line Surge Suppressor	1-53

Section 2 — Zener Diodes

1 Watt, Metal	2-1
1 Watt, Molded	2-4
2 Watt, Molded	2-6
2.5 Watt, Molded	2-7
5 Watt, Molded	2-8
10 Watt, Metal	2-9
50 Watt, Metal	2-15

Section 3 — Temperature Compensated Diodes

(All voltage types available from 6.2V through 200V)

250 mW, Glass	3-1
400 mW & 500 mW, Glass	3-3
1 Watt, Metal	3-5
10 Watt, Metal	3-7
50 Watt, Metal	3-8
Molded Assemblies	3-9

Section 4 — NPN Switching Transistors

C ² R® Definition and Specification	4-1
Transistor Selected by Collector Current	
I _c < 3 amps	4-3
I _c < 5 amps	4-6
I _c < 7 amps	4-8
I _c < 10 amps	4-9
I _c < 25 amps	4-10
I _c < 50 amps	4-11
Specification Sheets	4-13

Section 5 — Military Qualified Types and High-Rel Facilities

JAN/JANTX(V) Types Available	5-1
Facilities and Equipment Capabilities	5-2

Section 6 — Case Outlines

Diodes	6-1
Transistors	6-8

Section 7 — Representatives & Distributors

1

2

3

4

5

6

7

TRANSZORBS

ZENER DIODES

TEMPERATURE COMPENSATED DIODES

NPN SWITCHING TRANSISTORS

MILITARY QUALIFIED TYPES AND HIGH-REL FACILITIES

CASE OUTLINES

REPRESENTATIVES & DISTRIBUTORS

NUMERICAL INDEX — DIODES

TYPE	PAGE	TYPE	PAGE	TYPE	PAGE
1N429	3-9	1N1510	2-1	1N1738	3-9
1N821	3-1	1N1511	2-1	1N1739	3-9
1N823	3-1			1N1740	3-9
1N825	3-1	1N1512	2-1	1N1741	3-9
1N826	3-1	1N1513	2-1	1N1742	3-9
		1N1514	2-1		
1N827	3-1	1N1515	2-1	1N1765	2-1
1N828	3-1	1N1516	2-1	1N1766	2-1
1N829	3-1			1N1767	2-1
1N935	3-3	1N1517	2-1	1N1768	2-1
1N936	3-3	1N1518	2-1	1N1769	2-1
		1N1519	2-1		
1N937	3-3	1N1519	2-1	1N1770	2-1
1N938	3-3	1N1520	2-1	1N1771	2-1
1N939	3-3	1N1520	2-1	1N1772	2-1
1N940	3-3	1N1520	2-1	1N1773	2-1
1N941	3-3	1N1521	2-1	1N1774	2-1
		1N1522	2-1		
1N942	3-3	1N1523	2-1	1N1775	2-1
1N943	3-3	1N1524	2-1	1N1776	2-1
1N944	3-3			1N1777	2-1
1N945	3-3	1N1525	2-1	1N1778	2-1
1N946	3-3	1N1526	2-1	1N1779	2-1
		1N1527	2-1		
1N1351	2-9	1N1528	2-1	1N1780	2-1
1N1352	2-9	1N1530	3-9	1N1781	2-1
1N1353	2-9			1N1782	2-1
1N1354	2-9	1N1588	2-10	1N1783	2-1
1N1355	2-9	1N1589	2-10	1N1784	2-1
		1N1590	2-10		
1N1356	2-9	1N1591	2-10	1N1785	2-1
1N1357	2-9	1N1592	2-10	1N1786	2-1
1N1358	2-9			1N1787	2-1
1N1359	2-9	1N1593	2-10	1N1788	2-1
1N1360	2-9	1N1594	2-10	1N1789	2-1
		1N1595	2-10		
1N1361	2-9	1N1596	2-10	1N1790	2-1
1N1362	2-9	1N1597	2-10	1N1791	2-1
1N1363	2-9			1N1792	2-1
1N1364	2-9	1N1598	2-10	1N1793	2-1
1N1365	2-9	1N1599	2-10	1N1794	2-1
		1N1600	2-10		
1N1366	2-9	1N1601	2-10	1N1795	2-1
1N1367	2-9	1N1602	2-10	1N1796	2-1
1N1368	2-9			1N1797	2-1
1N1369	2-9	1N1603	2-10	1N1798	2-1
1N1370	2-9	1N1604	2-10	1N1799	2-1
		1N1605	2-10		
1N1371	2-9	1N1606	2-10	1N1800	2-1
1N1372	2-9	1N1607	2-10	1N1801	2-1
1N1373	2-9			1N1802	2-1
1N1374	2-9	1N1608	2-10	1N1803	2-10
1N1375	2-9	1N1609	2-10	1N1804	2-10
		1N1735	3-9		
1N1507	2-1	1N1736	3-9	1N1805	2-10
1N1508	2-1	1N1737	3-9	1N1806	2-10
1N1509	2-1			1N1807	2-10

See individual data sheets for suffix types.

NUMERICAL INDEX — DIODES (Cont'd)

TYPE	PAGE	TYPE	PAGE	TYPE	PAGE
1N1808	2-10	1N2010	2-11	1N2807	2-15
1N1809	2-10	1N2011	2-11	1N2808	2-15
				1N2809	2-15
1N1810	2-10	1N2012	2-11	1N2810	2-15
1N1811	2-10	1N2032-1-2	2-2	1N2811	2-15
1N1812	2-10	1N2033-1-2	2-2		
1N1813	2-10	1N2034-1-2-3	2-2	1N2812	2-15
1N1814	2-10	1N2035-1-2-3-4	2-2	1N2813	2-15
				1N2814	2-15
1N1815	2-10	1N2036-1-2	2-2	1N2815	2-15
1N1816	2-11	1N2037-1-2-3	2-2	1N2816	2-15
1N1817	2-11				
1N1818	2-11	1N2038-1-2-3	2-2	1N2817	2-15
1N1819	2-11	1N2039-1-2-3	2-2	1N2818	2-15
		1N2040-1-2-3	2-2	1N2819	2-15
				1N2820	2-15
1N1820	2-11			1N2821	2-15
1N1821	2-11	1N2041-1-2	2-12		
1N1822	2-11	1N2042-1-2	2-12		
1N1823	2-11	1N2043-1-2-3	2-12	1N2822	2-15
1N1824	2-11	1N2044-1-2-3-4	2-12	1N2823	2-15
		1N2045-1-2	2-12	1N2824	2-15
				1N2825	2-15
1N1825	2-11			1N2826	2-15
1N1826	2-11	1N2046-1-2-3	2-12		
1N1827	2-11	1N2047-1-2-3	2-12		
1N1828	2-11	1N2048-1-2-3	2-12	1N2827	2-15
1N1829	2-11	1N2049-1-2-3	2-12	1N2828	2-15
		1N2163	3-5	1N2829	2-15
				1N2830	2-15
1N1830	2-11			1N2831	2-15
1N1831	2-11	1N2164	3-5		
1N1832	2-11	1N2165	3-5	1N2832	2-15
1N1833	2-11	1N2166	3-5	1N2833	2-15
1N1834	2-11	1N2167	3-5	1N2834	2-15
		1N2168	3-5	1N2835	2-15
				1N2836	2-15
1N1835	2-11	1N2169	3-5		
1N1836	2-11	1N2170	3-5		
1N1875	2-2	1N2171	3-5	1N2837	2-15
1N1876	2-2	1N2498	2-11	1N2838	2-15
1N1877	2-2	1N2499	2-11	1N2839	2-15
				1N2840	2-15
1N1878	2-2			1N2841	2-15
1N1879	2-2	1N2500	2-11		
1N1880	2-2	1N2620	3-5		
1N1881	2-2	1N2621	3-5	1N2842	2-15
1N1882	2-2	1N2622	3-5	1N2843	2-15
		1N2623	3-5	1N2844	2-15
				1N2845	2-15
1N1883	2-2			1N2846	2-15
1N1884	2-2	1N2624	3-5		
1N1885	2-2	1N2765	3-9		
1N1886	2-2	1N2766	3-9	1N2970	2-13
1N1887	2-2	1N2767	3-9	1N2971	2-13
		1N2768	3-9	1N2972	2-13
				1N2973	2-13
1N1888	2-2				
1N1889	2-2	1N2769	3-9		
1N1890	2-2	1N2770	3-9	1N2974	2-13
		1N2804	2-15	1N2975	2-13
1N2008	2-11	1N2805	2-15	1N2976	2-13
1N2009	2-11	1N2806	2-15	1N2977	2-13

See individual data sheets for suffix types.

NUMERICAL INDEX — DIODES (Cont'd)

TYPE	PAGE	TYPE	PAGE	TYPE	PAGE
1N2978	2-13	1N3025	2-3	1N3318	3-9
		1N3026	2-3		
1N2979	2-13	1N3027	2-3	1N3319	3-9
1N2980	2-13	1N3028	2-3	1N3320	3-9
1N2981	2-13			1N3321	3-9
1N2982	2-13	1N3029	2-3	1N3322	3-9
1N2983	2-13	1N3030	2-3	1N3323	3-9
		1N3031	2-3		
1N2984	2-13	1N3032	2-3	1N3324	3-9
1N2985	2-13	1N3033	2-3	1N3325	3-9
1N2986	2-13			1N3326	3-9
1N2987	2-13	1N3034	2-3	1N3327	3-9
1N2988	2-13	1N3035	2-3	1N3328	3-9
		1N3036	2-3		
1N2989	2-13	1N3037	2-3	1N3329	3-9
1N2990	2-13	1N3038	2-3	1N3330	3-9
1N2991	2-13			1N3331	3-9
1N2992	2-13	1N3039	2-3	1N3332	3-9
1N2993	2-13	1N3040	2-3	1N3333	3-9
		1N3041	2-3		
1N2994	2-13	1N3042	2-3	1N3334	2-16
1N2995	2-13	1N3043	2-3	1N3335	2-16
1N2996	2-13			1N3336	2-16
1N2997	2-13	1N3044	2-3	1N3337	2-16
1N2998	2-13	1N3045	2-3	1N3338	2-16
		1N3046	2-3		
1N2999	2-13	1N3047	2-3	1N3339	2-16
1N3000	2-13	1N3048	2-3	1N3340	2-16
1N3001	2-13			1N3341	2-16
1N3002	2-13	1N3049	2-3	1N3342	2-16
1N3003	2-13	1N3050	2-3	1N3343	2-16
		1N3051	2-3		
1N3004	2-13	1N3154	3-3	1N3344	2-16
1N3005	2-13	1N3155	3-3	1N3345	2-16
1N3006	2-13			1N3346	2-16
1N3007	2-13	1N3156	3-3	1N3347	2-16
1N3008	2-13	1N3157	3-3	1N3348	2-16
		1N3199	3-9		
1N3009	2-13	1N3200	3-9	1N3349	2-16
1N3010	2-13	1N3201	3-9	1N3350	2-16
1N3011	2-13			1N3496	3-1
1N3012	2-13	1N3202	3-9	1N3497	3-1
1N3013	2-13	1N3305	3-9	1N3498	3-1
		1N3306	3-9		
1N3014	2-13	1N3307	3-9	1N3499	3-1
1N3015	2-13	1N3308	3-9	1N3500	3-1
1N3016	2-3			1N3580	3-6
1N3017	2-3	1N3309	3-9	1N3581	3-6
1N3018	2-3	1N3310	3-9	1N3582	3-6
		1N3311	3-9		
1N3019	2-3	1N3312	3-9	1N3583	3-6
1N3020	2-3	1N3313	3-9	1N3584	3-6
1N3021	2-3			1N3675	2-4
1N3022	2-3	1N3314	3-9	1N3676	2-4
1N3023	2-3	1N3315	3-9	1N3677	2-4
		1N3316	3-9		
1N3024	2-3	1N3317	3-9	1N3678	2-4

See individual data sheets for suffix types.

NUMERICAL INDEX — DIODES (Cont'd)

TYPE	PAGE	TYPE	PAGE	TYPE	PAGE
1N3679	2-4	1N3949	2-11	1N4301	3-8
1N3680	2-4	1N3984	2-11	1N4302	3-8
1N3681	2-4	1N3985	2-11	1N4303	3-8
1N3682	2-4	1N3986	2-11		
		1N3993	2-14	1N4304	3-8
1N3683	2-4			1N4565	3-4
1N3684	2-4	1N3994	2-14	1N4566	3-4
1N3685	2-4	1N3995	2-14	1N4567	3-4
1N3686	2-4	1N3996	2-14	1N4568	3-4
1N3687	2-4	1N3997	2-14		
		1N3998	2-14	1N4569	3-4
1N3688	2-4			1N4570	3-4
1N3689	2-4	1N3999	2-14	1N4571	3-4
1N3690	2-4	1N4000	2-14	1N4572	3-4
1N3691	2-4	1N4057	3-10	1N4573	3-4
1N3692	2-4	1N4058	3-10		
		1N4059	3-10	1N4574	3-4
1N3693	2-4			1N4575	3-4
1N3694	2-4	1N4060	3-10	1N4576	3-4
1N3695	2-4	1N4061	3-10	1N4577	3-4
1N3696	2-4	1N4062	3-10	1N4578	3-4
1N3697	2-4	1N4063	3-10		
		1N4064	3-10	1N4579	3-4
1N3698	2-4			1N4580	3-4
1N3699	2-4	1N4065	3-10	1N4581	3-4
1N3700	2-4	1N4066	3-10	1N4582	3-4
1N3701	2-4	1N4067	3-10	1N4583	3-4
1N3702	2-4	1N4068	3-10		
		1N4069	3-10	1N4584	3-4
1N3703	2-4			1N4728	2-5
1N3704	2-4	1N4070	3-10	1N4729	2-5
1N3705	2-4	1N4071	3-10	1N4730	2-5
1N3706	2-4	1N4072	3-10	1N4731	2-5
1N3707	2-4	1N4073	3-10		
		1N4074	3-10	1N4732	2-5
1N3708	2-4			1N4733	2-5
1N3709	2-4	1N4075	3-10	1N4734	2-5
1N3710	2-4	1N4076	3-10	1N4735	2-5
1N3779	3-4	1N4077	3-10	1N4736	2-5
1N3780	3-4	1N4078	3-10		
		1N4079	3-10	1N4737	2-5
1N3781	3-4			1N4738	2-5
1N3782	3-4	1N4080	3-10	1N4739	2-5
1N3783	3-4	1N4081	3-10	1N4740	2-5
1N3784	3-4	1N4082	3-10	1N4741	2-5
		1N4083	3-10		
1N3821	3-4	1N4084	3-10	1N4742	2-5
1N3822	3-4			1N4743	2-5
1N3823	3-4	1N4085	3-10	1N4744	2-5
1N3824	3-4	1N4295	3-4	1N4745	2-5
1N3825	3-4	1N4296	3-6	1N4746	2-5
		1N4297	3-7		
1N3826	3-4	1N4298	3-7	1N4747	2-5
1N3827	3-4			1N4748	2-5
1N3828	3-4	1N4299	3-7	1N4749	2-5
1N3829	3-4	1N4300	3-7	1N4750	2-5
1N3830	3-4			1N4751	2-5

See individual data sheets for suffix types.

NUMERICAL INDEX — DIODES (Cont'd)

TYPE	PAGE	TYPE	PAGE	TYPE	PAGE
1N4752	2-5	1N5023	2-7	1N5351	2-8
1N4753	2-5	1N5024	2-7	1N5352	2-8
1N4754	2-5			1N5353	2-8
1N4755	2-5	1N5025	2-7	1N5354	2-8
1N4756	2-5	1N5026	2-7	1N5355	2-8
		1N5027	2-7		
1N4757	2-5	1N5028	2-7	1N5356	2-8
1N4758	2-5	1N5029	2-7	1N5357	2-8
1N4759	2-5			1N5358	2-8
1N4760	2-5	1N5030	2-7	1N5359	2-8
1N4761	2-5	1N5031	2-7	1N5360	2-8
		1N5032	2-7		
1N4762	2-5	1N5033	2-7	1N5361	2-8
1N4763	2-5	1N5034	2-7	1N5362	2-8
1N4764	2-5			1N5363	2-8
1N4765	3-1	1N5035	2-7	1N5364	2-8
1N4766	3-1	1N5036	2-7	1N5365	2-8
		1N5037	2-7		
1N4767	3-1	1N5038	2-7	1N5366	2-8
1N4768	3-1	1N5039	2-7	1N5367	2-8
1N4769	3-1			1N5368	2-8
1N4770	3-1	1N5040	2-7	1N5369	2-8
1N4771	3-1	1N5041	2-7	1N5370	2-8
		1N5042	2-7		
1N4772	3-1	1N5043	2-7	1N5371	2-8
1N4773	3-1	1N5044	2-7	1N5372	2-8
1N4774	3-1			1N5373	2-8
1N4775	3-2	1N5045	2-7	1N5374	2-8
1N4776	3-2	1N5046	2-7	1N5375	2-8
		1N5047	2-7		
1N4777	3-2	1N5048	2-7	1N5376	2-8
1N4778	3-2	1N5049	2-7	1N5377	2-8
1N4779	3-2			1N5378	2-8
1N4780	3-2	1N5050	2-7	1N5379	2-8
1N4781	3-2	1N5051	2-7	1N5380	2-8
		1N5333	2-8		
1N4782	3-2	1N5334	2-8	1N5381	2-8
1N4783	3-2	1N5335	2-8	1N5382	2-8
1N4784	3-2			1N5383	2-8
1N5008	2-7	1N5336	2-8	1N5384	2-8
1N5009	2-7	1N5337	2-8	1N5385	2-8
		1N5338	2-8		
1N5010	2-7	1N5339	2-8	1N5386	2-8
1N5011	2-7	1N5340	2-8	1N5387	2-8
1N5012	2-7			1N5388	2-8
1N5013	2-7	1N5341	2-8	1N5555	1-3
1N5014	2-7	1N5342	2-8	1N5556	1-3
		1N5343	2-8		
1N5015	2-7	1N5344	2-8	1N5557	1-3
1N5016	2-7	1N5345	2-8	1N5558	1-3
1N5017	2-7			1N5629	1-5
1N5018	2-7	1N5346	2-8	1N5630	1-5
1N5019	2-7	1N5347	2-8	1N5631	1-5
		1N5348	2-8		
1N5020	2-7	1N5349	2-8	1N5632	1-5
1N5021	2-7	1N5350	2-8	1N5633	1-5
1N5022	2-7			1N5634	1-5

See individual data sheets for suffix types.

NUMERICAL INDEX — DIODES (Cont'd)

TYPE	PAGE	TYPE	PAGE	TYPE	PAGE
1N5635	1-5	1N6051	1-9	1N6280	1-12
1N5636	1-5	1N6052	1-9	1N6280A	1-12
		1N6053	1-9		
1N5637	1-5	1N6054	1-9	1N6281	1-12
1N5638	1-5	1N6055	1-9	1N6281A	1-12
1N5639	1-5			1N6282	1-12
1N5640	1-5	1N6056	1-9	1N6282A	1-12
1N5641	1-5	1N6057	1-9	1N6283	1-12
		1N6058	1-9		
1N5642	1-5	1N6059	1-9	1N6283A	1-12
1N5643	1-5	1N6060	1-9	1N6284	1-12
1N5644	1-5			1N6284A	1-12
1N5645	1-5	1N6061	1-9	1N6285	1-12
1N5646	1-5	1N6062	1-9	1N6285A	1-12
		1N6063	1-9		
1N5647	1-5	1N6064	1-9	1N6286	1-12
1N5648	1-5	1N6065	1-9	1N6286A	1-12
1N5649	1-5			1N6287	1-12
1N5650	1-5	1N6066	1-9	1N6287A	1-12
1N5651	1-5	1N6067	1-9	1N6288	1-12
		1N6068	1-9		
1N5652	1-5	1N6069	1-9	1N6288A	1-12
1N5653	1-5	1N6070	1-9	1N6289	1-12
1N5654	1-5			1N6289A	1-12
1N5655	1-5	1N6071	1-9	1N6290	1-12
1N5656	1-5	1N6072	1-9	1N6290A	1-12
		1N6267	1-12		
1N5658	1-5	1N6267A	1-12	1N6291	1-12
1N5659	1-5	1N6268	1-12	1N6291A	1-12
1N5660	1-5			1N6292	1-12
1N5661	1-5	1N6268A	1-12	1N6292A	1-12
1N5662	1-5	1N6269	1-12	1N6293	1-12
		1N6269A	1-12		
1N5663	1-5	1N6270	1-12	1N6293A	1-12
1N5664	1-5	1N6270A	1-12	1N6294	1-12
1N5665	1-5			1N6294A	1-12
1N5907	1-7	1N6271	1-12	1N6295	1-12
1N5908	1-7	1N6271A	1-12	1N6295A	1-12
		1N6272	1-12		
1N6036	1-9	1N6272A	1-12	1N6296	1-12
1N6037	1-9	1N6273	1-12	1N6296A	1-12
1N6038	1-9				
1N6039	1-9	1N6273A	1-12	1N6297	1-12
1N6040	1-9	1N6274	1-12	1N6297A	1-12
		1N6274A	1-12	1N6298	1-12
1N6041	1-9	1N6275	1-12		
1N6042	1-9	1N6275A	1-12	1N6298A	1-12
1N6043	1-9			1N6299	1-12
1N6044	1-9	1N6276	1-12	1N6299A	1-12
1N6045	1-9	1N6276A	1-12	1N6300	1-12
		1N6277	1-12	1N6300A	1-12
1N6046	1-9	1N6277A	1-12		
1N6047	1-9	1N6278	1-12	1N6301	1-12
1N6048	1-9			1N6301A	1-12
1N6049	1-9	1N6278A	1-12	1N6302	1-12
1N6050	1-9	1N6279	1-12	1N6302A	1-12
		1N6279A	1-12		

See individual data sheets for suffix types.

NUMERICAL INDEX — DIODES (Cont'd)

TYPE	PAGE	TYPE	PAGE	TYPE	PAGE
1N6303	1-12	1.5KC16	1-13	1.5KE82	1-12
1N6303A	1-12	1.5KC18	1-13	1.5KE91	1-12
1.5K6.8	1-6			1.5KE100	1-12
1.5K7.5	1-6	1.5KC20	1-13	1.5KE110	1-12
1.5K8.2	1-6	1.5KC22	1-13	1.5KE120	1-12
		1.5KC24	1-13		
1.5K9.1	1-6	1.5KC27	1-13	1.5KE130	1-12
1.5K10	1-6	1.5KC30	1-13	1.5KE150	1-12
1.5K11	1-6			1.5KE160	1-12
1.5K12	1-6	1.5KC33	1-13	1.5KE170	1-12
1.5K13	1-6	1.5KC36	1-13	1.5KE180	1-12
		1.5KC39	1-13		
1.5K15	1-6	1.5KC43	1-13	1.5KE200	1-12
1.5K16	1-6	1.5KC47	1-13	1.5KE220	1-12
1.5K18	1-6			1.5KE250	1-12
1.5K20	1-6	1.5KC51	1-13	1.5KE300	1-12
1.5K22	1-6	1.5KC56	1-13	1.5KE350	1-12
		1.5KC62	1-13		
1.5K24	1-6	1.5KC68	1-13	1.5KE400	1-12
1.5K27	1-6	1.5KC75	1-13	5KP5.0	1-15
1.5K30	1-6			5KP6.0	1-15
1.5K33	1-6	1.5KC82	1-13	5KP6.5	1-15
1.5K36	1-6	1.5KC91	1-13	5KP7.0	1-15
		1.5KC100	1-13		
1.5K39	1-6	1.5KC110	1-13	5KP7.5	1-15
1.5K43	1-6	1.5KE6.8	1-12	5KP8.0	1-15
1.5K47	1-6			5KP8.5	1-15
1.5K51	1-6	1.5KE7.5	1-12	5KP9.0	1-15
1.5K56	1-6	1.5KE8.2	1-12	5KP10	1-15
		1.5KE9.1	1-12		
1.5K62	1-6	1.5KE10	1-12	5KP11	1-15
1.5K68	1-6	1.5KE11	1-12	5KP12	1-15
1.5K75	1-6			5KP13	1-15
1.5K82	1-6	1.5KE12	1-12	5KP14	1-15
1.5K91	1-6	1.5KE13	1-12	5KP15	1-15
		1.5KE15	1-12		
1.5K100	1-6	1.5KE16	1-12	5KP16	1-15
1.5K110	1-6	1.5KE18	1-12	5KP17	1-15
1.5K120	1-6			5KP18	1-15
1.5K130	1-6	1.5KE20	1-12	5KP20	1-15
1.5K150	1-6	1.5KE22	1-12	5KP22	1-15
		1.5KE24	1-12		
1.5K160	1-6	1.5KE27	1-12	5KP24	1-15
1.5K170	1-6	1.5KE30	1-12	5KP26	1-15
1.5K180	1-6			5KP28	1-15
1.5K200	1-6	1.5KE33	1-12	5KP30	1-15
1.5KC6.8	1-13	1.5KE36	1-12	5KP33	1-15
		1.5KE39	1-12		
1.5KC7.5	1-13	1.5KE43	1-12	5KP36	1-15
1.5KC8.2	1-13	1.5KE47	1-12	5KP40	1-15
1.5KC9.1	1-13			5KP43	1-15
1.5KC10	1-13	1.5KE51	1-12	5KP45	1-15
1.5KC11	1-13	1.5KE56	1-12	5KP48	1-15
		1.5KE62	1-12		
1.5KC12	1-13	1.5KE68	1-12	5KP51	1-15
1.5KC13	1-13	1.5KE75	1-12	5KP54	1-15
1.5KC15	1-13			5KP58	1-15

See individual data sheets for suffix types.

NUMERICAL INDEX — DIODES (Cont'd)

TYPE	PAGE	TYPE	PAGE	TYPE	PAGE
5KP60	1-15	704-34	1-4	LC7.0A	1-34
5KP64	1-15	704-45	1-4	LC7.5	1-34
		704-56	1-4		
5KP70	1-15	704-190	1-4	LC7.5A	1-34
5KP75	1-15	704-15K36	1-21	LC-8.0	1-34
5KP78	1-15			LC8.0	1-34
5KP85	1-15	GHV-2	1-53	LC8.0A	1-34
5KP90	1-15	GHV-3	1-53	LC8.5	1-34
		GHV-4	1-53	LC8.5A	1-34
5KP100	1-15	GHV-5	1-53	LC9.0	1-34
5KP110	1-15	GHV-6	1-53	LC9.0A	1-34
15KP17	1-17			LC10	1-34
15KP18	1-17	GHV-7	1-53		
15KP20	1-17	GHV-8	1-53	LC10A	1-34
		GHV-9	1-53	LC11	1-34
15KP22	1-17	GHV-10	1-53	LC11A	1-34
15KP24	1-17	GHV-11	1-53	LC12	1-34
15KP26	1-17			LC12A	1-34
15KP28	1-17	GHV-12	1-53		
15KP30	1-17	GHV-13	1-53	LC13	1-34
		GHV-14	1-53	LC13A	1-34
15KP33	1-17	GHV-15	1-53	LC14	1-34
15KP36	1-17	GHV-16	1-53	LC14A	1-34
15KP40	1-17			LC15	1-34
15KP43	1-17	GSV-101	1-51		
15KP45	1-17	GSV-102	1-51	LC15A	1-34
		GSV-103	1-51	LC16	1-34
15KP48	1-17	GMP-5	1-24	LC16A	1-34
15KP51	1-17	GMP-5A	1-24	LC17	1-34
15KP54	1-17			LC17A	1-34
15KP58	1-17	GMP-5B	1-24		
15KP60	1-17	ICT-5	1-25	LC18	1-34
		ICT-8	1-25	LC18A	1-34
15KP64	1-17	ICT-10	1-25	LC20	1-34
15KP70	1-17	ICT-12	1-25	LC20A	1-34
15KP75	1-17			LC22	1-34
15KP78	1-17	ICT-15	1-25		
15KP85	1-17	ICT-18	1-25	LC22A	1-34
		ICT-22	1-25	LC24	1-34
15KP90	1-17	ICT-36	1-25	LC24A	1-34
15KP100	1-17	ICT-45	1-25	LC26	1-34
15KP110	1-17			LC26A	1-34
15KP120	1-17	ICTE-5	1-29		
15KP130	1-17	ICTE-8	1-29	LC28	1-34
		ICTE-10	1-29	LC28A	1-34
15KP150	1-17	ICTE-12	1-29	LC30	1-34
15KP160	1-17	ICTE-15	1-29	LC30A	1-34
15KP170	1-17			LC33	1-34
15KP180	1-17	ICTE-18	1-29		
15KP200	1-17	ICTE-22	1-29	LC33A	1-34
		ICTE-36	1-29	LC36	1-34
15KP220	1-17	ICTE-45	1-29	LC36A	1-34
15KP240	1-17			LC40	1-34
15KP260	1-17	LC6.5	1-34	LC40A	1-34
15KP280	1-17	LC6.5A	1-34		
60KS200C	1-19	LC7.0	1-34	LC43	1-34

See individual data sheets for suffix types.

NUMERICAL INDEX — DIODES (Cont'd)

TYPE	PAGE	TYPE	PAGE	TYPE	PAGE
LC43A	1-34	LCE9.0	1-36	LCE54A	1-36
LC45	1-34	LCE9.0A	1-36	LCE58	1-36
LC45A	1-34			LCE58A	1-36
LC48	1-34	LCE10	1-36	LCE60	1-36
		LCE10A	1-36	LCE60A	1-36
LC48A	1-34	LCE11	1-36		
LC51	1-34	LCE11A	1-36	LCE64	1-36
LC51A	1-34	LCE12	1-36	LCE64A	1-36
LC54	1-34			LCE70	1-36
LC54A	1-34	LCE12A	1-36	LCE70A	1-36
		LCE13	1-36	LCE75	1-36
LC58	1-34	LCE13A	1-36		
LC58A	1-34	LCE14	1-36	LCE75A	1-36
LC60	1-34	LCE14A	1-36	LCE80	1-36
LC60A	1-34			LCE80A	1-36
LC64	1-34	LCE15	1-36	LCE90	1-36
		LCE15A	1-36	LCE90A	1-36
LC64A	1-34	LCE16	1-36		
LC70	1-34	LCE16A	1-36	LCE100	1-36
LC70A	1-34	LCE17	1-36	LCE100A	1-36
LC75	1-34			LCE110	1-36
LC75A	1-34	LCE17A	1-36	LCE110A	1-36
		LCE18	1-36	LCE120	1-36
LC80	1-34	LCE18A	1-36		
LC80A	1-34	LCE20	1-36	LCE120A	1-36
LC90	1-34	LCE20A	1-36	LCE130	1-36
LC90A	1-34			LCE130A	1-36
LC100	1-34	LCE22	1-36	LCE150	1-36
		LCE22A	1-36	LCE150A	1-36
LC100A	1-34	LCE24	1-36		
LC110	1-34	LCE24A	1-36	LCE160	1-36
LC110A	1-34	LCE26	1-36	LCE160A	1-36
LC120	1-34			LCE170	1-36
LC120A	1-34	LCE26A	1-36	LCE170A	1-36
		LCE28	1-36	LMZ3.3	2-6
LC130	1-34	LCE28A	1-36		
LC130A	1-34	LCE30	1-36	LMZ3.6	2-6
LC150	1-34	LCE30A	1-36	LMZ3.9	2-6
LC150A	1-34			LMZ4.3	2-6
LC160	1-34	LCE33	1-36	LMZ4.7	2-6
		LCE33A	1-36	LMZ5.1	2-6
LC160A	1-34	LCE36	1-36		
LC170	1-34	LCE36A	1-36	LMZ5.6	2-6
LC170A	1-34	LCE40	1-36	LMZ6.2	2-6
LCE6.5	1-36			LMZ6.8	2-6
LCE6.5A	1-36	LCE40A	1-36	LMZ7.5	2-6
		LCE43	1-36	LMZ8.2	2-6
LCE7.0	1-36	LCE43A	1-36		
LCE7.0A	1-36	LCE45	1-36	LMZ9.1	2-6
LCE7.5	1-36	LCE45A	1-36	LMZ10	2-6
LCE7.5A	1-36			LMZ11	2-6
LCE8.0	1-36	LCE48	1-36	LMZ12	2-6
		LCE48A	1-36	LMZ13	2-6
LCE8.0A	1-36	LCE51	1-36		
LCE8.5	1-36	LCE51A	1-36	LMZ14	2-6
LCE8.5A	1-36	LCE54	1-36	LMZ15	2-6

See individual data sheets for suffix types.

NUMERICAL INDEX — DIODES (Cont'd)

TYPE	PAGE	TYPE	PAGE	TYPE	PAGE
LMZ16	2-6	PIP24	1-47	SA1002	1-50
LMZ18	2-6	PIP30	1-47	SA1002A	1-50
LMZ20	2-6	PIP60	1-47		
		PIP120	1-47	SA1003	1-50
LMZ22	2-6			SA1003A	1-50
LMZ24	2-6	PIP208	1-47	SA1004	1-50
LMZ27	2-6	PIP250	1-47	SA1004A	1-50
LMZ30	2-6	PIP440	1-47	SA1005	1-50
LMZ33	2-6	PIP500	1-47		
		P6KE6.8	1-45	SA1005A	1-50
LMZ36	2-6			SA1006	1-50
LMZ39	2-6	P6KE7.5	1-45	SA1006A	1-50
LMZ43	2-6	P6KE8.2	1-45	SA1007	1-50
LMZ47	2-6	P6KE9.1	1-45		
LMZ51	2-6	P6KE10	1-45	SA1007A	1-50
		P6KE11	1-45	SA1008	1-50
LMZ56	2-6			SA1008A	1-50
LMZ62	2-6	P6KE12	1-45	SA1009	1-50
		P6KE13	1-45	SA1009A	1-50
LMZ68	2-6	P6KE15	1-45		
LMZ75	2-6	P6KE16	1-45	SA1010	1-50
LMZ82	2-6	P6KE18	1-45	SA1010A	1-50
LMZ91	2-6			SA1011	1-50
LMZ100	2-6	P6KE20	1-41	SA1011A	1-50
		P6KE22	1-41	SA1012	1-50
LMZ110	2-6	P6KE24	1-41	SA1012A	1-50
LMZ120	2-6	P6KE27	1-41		
LMZ130	2-6	P6KE30	1-41	SA1013	1-50
LMZ150	2-6			SA1013A	1-50
LMZ160	2-6	P6KE33	1-41	SA1014	1-50
		P6KE36	1-41	SA1014A	1-50
LMZ180	2-6	P6KE39	1-41	SA1015	1-50
LMZ200	2-6	P6KE43	1-41		
MPT-5	1-37	P6KE47	1-41	SA1015A	1-50
MPT-8	1-37			SA1016	1-50
MPT-10	1-37	P6KE51	1-41	SA1016A	1-50
		P6KE56	1-41	SA1017	1-50
MPT-12	1-37	P6KE62	1-41	SA1017A	1-50
MPT-15	1-37	P6KE68	1-41		
MPT-18	1-37	P6KE75	1-41	SA1018	1-50
MPT-22	1-37			SA1018A	1-50
MPT-36	1-37	P6KE82	1-41	SA1019	1-50
		P6KE91	1-41	SA1019A	1-50
MPT-45	1-37	P6KE100	1-41	SA1020	1-50
MPTE-5	1-41	P6KE110	1-41		
MPTE-8	1-41	P6KE120	1-41	SA1020A	1-50
MPTE-10	1-41			SA1021	1-50
MPTE-12	1-41	P6KE130	1-41	SA1021A	1-50
		P6KE150	1-41	SA1022	1-50
MPTE-15	1-41	P6KE160	1-41	SA1022A	1-50
MPTE-18	1-41	P6KE170	1-41		
MPTE-22	1-41	P6KE180	1-41	SA1023	1-50
MPTE-36	1-41			SA1023A	1-50
MPTE-45	1-41	P6KE200	1-41	SA1024	1-50
		SA1001	1-50	SA1024A	1-50
PIP8.4	1-47	SA1001A	1-50	SA1025	1-50

See individual data sheets for suffix types.

NUMERICAL INDEX — DIODES (Cont'd)

TYPE	PAGE	TYPE	PAGE	TYPE	PAGE
SA1025A	1-50	SA1030	1-50	SA1034	1-50
SA1026	1-50			SA1034A	1-50
SA1026A	1-50	SA1030A	1-50	SA1035	1-50
SA1027	1-50	SA1031	1-50		
SA1027A	1-50	SA1031A	1-50	SA1035A	1-50
		SA1032	1-50	SA1036	1-50
SA1028	1-50	SA1032A	1-50	SA1036A	1-50
SA1028A	1-50			SA1037	1-50
SA1029	1-50	SA1033	1-50	SA1037A	1-50
SA1029A	1-50	SA1033A	1-50		

See individual data sheets for suffix types.

NUMERICAL INDEX—TRANSISTORS

TYPE	PAGE	TYPE	PAGE	TYPE	PAGE
2N545	4-3	2N2658	4-6	2N2893	4-6
2N546	4-3	2N2811	4-9	2N2983	4-5
2N547	4-3			2N2984	4-5
2N548	4-3	2N2812	4-9	2N2985	4-5
2N549	4-3	2N2813	4-9	2N2986	4-5
		2N2814	4-9		
2N550	4-3	2N2815	4-10	2N2987	4-3
2N1052	4-3	2N2816	4-10	2N2988	4-3
2N1054	4-3			2N2989	4-3
2N1055	4-3	2N2817	4-13	2N2990	4-3
2N1116	4-3	2N2818	4-13	2N3226	4-6
		2N2819	4-10		
2N1117	4-3	2N2820	4-10	2N3262	4-3
2N1208	4-6	2N2821	4-15	2N3265	4-10
2N1209	4-6			2N3266	4-10
2N1212	4-6	2N2822	4-10	2N3418	4-21
2N1252	4-3	2N2823	4-11	2N3419	4-21
		2N2824	4-11		
2N1253	4-3	2N2825	4-17	2N3420	4-21
2N1445	4-3	2N2849	4-5	2N3421	4-21
2N1616	4-6			2N3469	4-6
2N1616A	4-8	2N2849-1	4-5	2N3506	4-23
2N1617	4-6	2N2849-2	4-5	2N3507	4-23
		2N2850	4-5		
2N1617A	4-8	2N2850-1	4-5	2N3597	4-10
2N1618	4-6	2N2850-2	4-5	2N3598	4-10
2N1618A	4-8			2N3599	4-10
2N1647	4-5	2N2851	4-5	2N3675	4-5
2N1648	4-5	2N2851-1	4-5	2N3676	4-5
		2N2851-2	4-5		
2N1649	4-5	2N2852	4-5	2N3738	4-25
2N1650	4-5	2N2852-1	4-5	2N3739	4-25
2N1700	4-3			2N3744	4-6
2N1702	4-6	2N2852-2	4-5	2N3745	4-6
2N1714	4-3	2N2853	4-5	2N3746	4-6
		2N2853-1	4-5		
2N1715	4-3	2N2853-2	4-5	2N3747	4-6
2N1716	4-3	2N2854	4-5	2N3748	4-6
2N1717	4-3			2N3749	4-6
2N1724	4-6	2N2854-1	4-5	2N3750	4-6
2N1724A	4-6	2N2854-2	4-5	2N3751	4-6
		2N2855	4-5		
2N1725	4-6	2N2855-1	4-5	2N3752	4-6
2N1983	4-3	2N2855-2	4-5	2N3766	4-5
2N1984	4-3			2N3767	4-5
2N1985	4-3	2N2856	4-5	2N3852	4-6
2N2018	4-3	2N2856-1	4-5	2N3853	4-6
		2N2856-2	4-5		
2N2019	4-3	2N2877	4-19	2N3878	4-8
2N2101	4-3	2N2878	4-19	2N3879	4-8
2N2150	4-3			2N3996	4-27
2N2151	4-3	2N2879	4-19	2N3997	4-27
2N2632	4-6	2N2880	4-19	2N3998	4-27
		2N2890	4-6		
2N2633	4-6	2N2891	4-6	2N3999	4-27
2N2634	4-6	2N2892	4-6	2N4000	4-3
2N2657	4-6			2N4001	4-3

See individual data sheets for suffix types.

NUMERICAL INDEX—TRANSISTORS (Cont'd)

TYPE	PAGE	TYPE	PAGE	TYPE	PAGE
2N4002	4-29	2N5218	4-49	2N5610	4-7
2N4003	4-29	2N5237	4-51	2N5612	4-7
		2N5239	4-7	2N5658	4-9
2N4070	4-31	2N5288	4-9		
2N4071	4-33			2N5659	4-9
2N4075	4-5	2N5289	4-9	2N5660	4-59
2N4076	4-5	2N5313	4-9	2N5661	4-59
2N4111	4-6	2N5315	4-9	2N5662	4-61
		2N5317	4-9	2N5663	4-61
2N4112	4-6	2N5319	4-9		
2N4113	4-6			2N5664	4-63
2N4114	4-6	2N5320	4-4	2N5665	4-63
2N4115	4-6	2N5321	4-4	2N5666	4-65
2N4116	4-6	2N5334	4-5	2N5667	4-65
		2N5335	4-5	2N5681	4-3
2N4150	4-35	2N5336	4-7		
2N4210	4-10			2N5682	4-3
2N4211	4-10	2N5337	4-7	2N5729	4-7
2N4231	4-5	2N5338	4-7	2N5730	4-9
2N4232	4-5	2N5339	4-7	2N5731	4-10
		2N5346	4-8	2N5732	4-67
2N4233	4-5	2N5347	4-8		
2N4237	4-3			2N5733	4-11
2N4238	4-3	2N5348	4-8	2N5734	4-11
2N4239	4-3	2N5349	4-8	2N5854	4-9
2N4240	4-37	2N5387	4-53	2N6032	4-69
		2N5388	4-53	2N6033	4-71
2N4300	4-4	2N5389	4-55		
2N4301	4-9			2N6077	4-73
2N4395	4-7	2N5412	4-9	2N6078	4-73
2N4396	4-7	2N5427	4-8	2N6079	4-75
2N4863	4-39	2N5428	4-8	2N6215	4-11
		2N5429	4-8	2N6232	4-77
2N4864	4-39	2N5430	4-8		
2N4877	4-5	2N5477	4-8	2N6233	4-79
2N4910	4-3			2N6234	4-79
2N4911	4-3	2N5478	4-8	2N6235	4-79
2N4912	4-3	2N5479	4-8	2N6274	4-81
		2N5480	4-8	2N6275	4-83
2N4913	4-7	2N5487	4-7		
2N4914	4-7	2N5487-1	4-7	2N6276	4-83
2N4915	4-7			2N6277	4-85
2N5050	4-41	2N5488	4-7	2N6278	4-87
2N5051	4-41	2N5488-1	4-7	2N6279	4-89
		2N5541	4-57	2N6280	4-89
2N5052	4-41	2N5542	4-57		
2N5074	4-43	2N5552	4-9	2N6281	4-89
2N5075	4-45			2N6338	4-91
2N5076	4-45	2N5552-1	4-9	2N6339	4-91
		2N5598	4-4	2N6340	4-93
2N5077	4-45	2N5600	4-4	2N6341	4-93
2N5148	4-47	2N5602	4-4		
2N5150	4-47	2N5604	4-4	2N6653	4-95
2N5152	4-7			2N6654	4-95
2N5154	4-7	2N5606	4-7	2N6655	4-95
		2N5608	4-7	GSDR 10020	4-105
2N5202	4-5			GSDR 10025	4-105

See individual data sheets for suffix types.

NUMERICAL INDEX-TRANSISTORS (Cont'd)

TYPE	PAGE	TYPE	PAGE	TYPE	PAGE
GSDR 15020	4-107	XGSA1035	4-127	XGSQ5035	4-141
GSDR 15025	4-107	XGSA1040	4-127	XGSQ5040	4-141
GSDS 50020	4-109	XGSA1530	4-129	XGSQ7530	4-143
GSTU 4030	4-115	XGSA1535	4-129		
GSTU 4035	4-115			XGSQ7535	4-143
		XGSA1540	4-129	XGSQ7540	4-143
GSTU 4040	4-115	XGSA3030	4-131	XGSR3030	4-146
GSTU 6030	4-117	XGSA3035	4-131	XGSR3035	4-146
GSTU 6035	4-117	XGSA3040	4-131	XGSR3040	4-146
GSTU 6040	4-117	XGSA5030	4-133		
GSTU 8030	4-119			XGSR5030	4-148
		XGSA5035	4-133	XGSR5035	4-148
GSTU 8035	4-119	XGSA5040	4-133	XGSR5040	4-148
GSTU 8040	4-119	XGSQ1030	4-135	XGSR7530	4-150
GSTU 12030	4-121	XGSQ1035	4-135	XGSR7535	4-150
GSTU 12035	4-121	XGSQ1040	4-135		
GSTU 12040	4-121			XGSR7540	4-150
		XGSQ1530	4-137	XGSR10030	4-153
XDAR10025	4-123	XGSQ1535	4-137	XGSR10035	4-153
XDAR10030	4-123	XGSQ1540	4-137	XGSR10040	4-153
XDAR10035	4-123	XGSQ3030	4-139		
XGS7001	4-125	XGSQ3035	4-139	XGSR15030	4-153
XGS7002	4-125			XGSR15035	4-153
		XGSQ3040	4-139	XGSR15040	4-153
XGSA1030	4-127	XGSQ5030	4-141	XGSR50020	4-157

See individual data sheets for suffix types.

AVAILABLE JEDEC TYPES OR SUGGESTED REPLACEMENTS DIODES

JEDEC TYPE NUMBER	RECOMMENDED GENERAL SEMICONDUCTOR REPLACEMENT	PAGE	JEDEC TYPE NUMBER	RECOMMENDED GENERAL SEMICONDUCTOR REPLACEMENT	PAGE
1N429		3-9	1N946B		3-3
1N430	1N3156	3-3	1N1416	1N2972B	2-13
1N430A	1N3157	3-3	1N1417	1N2976B	2-13
1N430B	1N3157A	3-3	1N1418	1N2979B	2-13
1N821		3-1	1N1419	1N2982B	2-13
1N821A		3-1	1N1420	1N2985B	2-13
1N823		3-1	1N1421	1N2988B	2-13
1N823A		3-1	1N1422	1N3001B	2-3
1N825		3-1	1N1423	1N3005B	2-13
1N825A		3-1	1N1424	1N3011B	2-13
1N826		3-1	1N1425	1N4738A	2-5
1N827		3-1	1N1426	1N4742A	2-5
1N827A		3-1	1N1427	1N4744A	2-5
1N828		3-1	1N1428	1N4746A	2-5
1N829		3-1	1N1429	1N4748A	2-5
1N829A		3-1	1N1430	1N4750A	2-5
1N935		3-3	1N1431	1N4760A	2-5
1N935A		3-3	1N1432	1N4764A	2-5
1N935B		3-3	1N1433	1N3707B	2-4
1N936		3-3	1N1482	1N3995A	2-14
1N936A		3-3	1N1483	1N3998A	2-14
1N936B		3-3	1N1484	1N4732A	2-5
1N937		3-3	1N1485	1N4735A	2-5
1N937A		3-3	1N1507		2-1
1N937B		3-3	1N1508		2-1
1N938		3-3	1N1509		2-1
1N938A		3-3	1N1510		2-1
1N938B		3-3	1N1511		2-1
1N939		3-3	1N1512		2-1
1N939A		3-3	1N1513		2-1
1N939B		3-3	1N1514		2-1
1N940		3-3	1N1515		2-1
1N940A		3-3	1N1516		2-1
1N940B		3-3	1N1517		2-1
1N941		3-3	1N1518		2-1
1N941A		3-3	1N1519		2-1
1N941B		3-3	1N1520		2-1
1N942		3-3	1N1521		2-1
1N942A		3-3	1N1522		2-1
1N942B		3-3	1N1523		2-1
1N943		3-3	1N1524		2-1
1N943A		3-3	1N1525		2-1
1N943B		3-3	1N1526		2-1
1N944		3-3	1N1527		2-1
1N944A		3-3	1N1528		2-1
1N944B		3-3	1N1530		3-9
1N945		3-3	1N1530A		3-9
1N945A		3-3	1N1588		2-10
1N945B		3-3	1N1589		2-10
1N946		3-3	1N1590		2-10
1N946A		3-3			

Available in JAN and JANTX

**AVAILABLE JEDEC TYPES OR SUGGESTED REPLACEMENTS
DIODES**

JEDEC TYPE NUMBER	RECOMMENDED GENERAL SEMICONDUCTOR REPLACEMENT	PAGE	JEDEC TYPE NUMBER	RECOMMENDED GENERAL SEMICONDUCTOR REPLACEMENT	PAGE
1N1591		2-10	1N1780		2-1
1N1592		2-10	1N1781		2-1
1N1593		2-10	1N1782		2-1
1N1594		2-10	1N1783		2-1
1N1595		2-10			
			1N1784		2-1
1N1596		2-10	1N1785		2-1
1N1597		2-10	1N1786		2-1
1N1598		2-10	1N1787		2-1
1N1599		2-10	1N1788		2-1
1N1600		2-10			
			1N1789		2-1
1N1601		2-10	1N1790		2-1
1N1602		2-10	1N1791		2-1
1N1603		2-10	1N1792		2-1
1N1604		2-10	1N1793		2-1
1N1605		2-10			
			1N1794		2-1
1N1606		2-10	1N1795		2-1
1N1607		2-10	1N1796		2-1
1N1608		2-10	1N1797		2-1
1N1609		2-10	1N1798		2-1
1N1735		3-9			
			1N1799		2-1
1N1736		3-9	1N1800		2-1
1N1736A		3-9	1N1801		2-1
1N1737		3-9	1N1802		2-1
1N1737A		3-9	1N1803		2-10
1N1738		3-9	1N1804		2-10
1N1738A		3-9	1N1805		2-10
1N1739		3-9	1N1806		2-10
1N1739A		3-9	1N1807		2-10
1N1740		3-9	1N1808		2-10
1N1740A		3-9	1N1809		2-10
1N1741		3-9	1N1810		2-10
1N1741A		3-9	1N1811		2-10
1N1742		3-9	1N1812		2-10
1N1742A		3-9	1N1813		2-10
1N143	1N2974A	3-9	1N1814		2-10
1N1744	1N4740	3-9	1N1815		2-10
1N1765		2-1	1N1816		2-11
1N1766		2-1	1N1817		2-11
1N1767		2-1	1N1818		2-11
1N1768		2-1	1N1819		2-11
1N1769		2-1	1N1820		2-11
1N1770		2-1	1N1821		2-11
1N1771		2-1	1N1822		2-11
1N1772		2-1	1N1823		2-11
1N1773		2-1	1N1824		2-11
1N1774		2-1	1N1825		2-11
1N1775		2-1	1N1826		2-11
1N1776		2-1	1N1827		2-11
1N1777		2-1	1N1828		2-11
1N1778		2-1	1N1829		2-11
1N1779		2-1	1N1830		2-11

**AVAILABLE JEDEC TYPES OR SUGGESTED REPLACEMENTS
DIODES**

JEDEC TYPE NUMBER	RECOMMENDED GENERAL SEMICONDUCTOR REPLACEMENT	PAGE	JEDEC TYPE NUMBER	RECOMMENDED GENERAL SEMICONDUCTOR REPLACEMENT	PAGE
1N1831		2-11	1N2164A		3-5
1N1832		2-11	1N2165		3-5
1N1833		2-11	1N2165A		3-5
1N1834		2-11	1N2166		3-5
			1N2166A		3-5
1N1835		2-11			
1N1836		2-11	1N2167		3-5
1N1875		2-2	1N2167A		3-5
1N1876		2-2	1N2168		3-5
1N1877		2-2	1N2168A		3-5
			1N2169		3-5
1N1878		2-2			
1N1879		2-2	1N2169A		3-5
1N1880		2-2	1N2170		3-5
1N1881		2-2	1N2170A		3-5
1N1882		2-2	1N2171		3-5
			1N2171A		3-5
1N1883		2-2			
1N1884		2-2	1N2214	1N3827	2-3
1N1885		2-2	1N2498		2-11
1N1886		2-2	1N2499		2-11
1N1887		2-2	1N2500		2-11
1N1888		2-2	1N2620		3-5
1N1889		2-2			
			1N2620A		3-5
1N1890		2-2	1N2620B		3-5
1N1905	1N3008A	2-13	1N2621		3-5
1N1906	1N3011A	2-13	1N2621A		3-5
1N2008		2-11	1N2621B		3-5
1N2009		2-11			
			1N2622		3-5
1N2010		2-11	1N2622A		3-5
1N2011		2-11	1N2622B		3-5
1N2012		2-11	1N2623		3-5
1N2032		2-2	1N2623A		3-5
1N2033		2-2	1N2623B		3-5
1N2034		2-2	1N2624		3-5
1N2035		2-2	1N2624A		3-5
1N2036		2-2	1N2624B		3-5
1N2037		2-2	1N2625	1N937	3-3
1N2038		2-2	1N2625A	1N937A	3-3
1N2039		2-2	1N2625B	1N937B	3-3
1N2040		2-2	1N2626	1N938	3-3
1N2041		2-12	1N2626A	1N938A	3-3
1N2042		2-12	1N2626B	1N938B	3-3
1N2043		2-12	1N2765		3-9
1N2044		2-12	1N2765A		3-9
1N2045		2-12	1N2766		3-9
1N2046		2-12	1N2766A		3-9
1N2047		2-12	1N2767		3-9
1N2048		2-12	1N2767A		3-9
1N2049		2-12	1N2768		3-9
1N2163		3-5	1N2768A		3-9
1N2163A		3-5	1N2769		3-9
1N2164		3-5	1N2769A		3-9

**AVAILABLE JEDEC TYPES OR SUGGESTED REPLACEMENTS
DIODES**

JEDEC TYPE NUMBER	RECOMMENDED GENERAL SEMICONDUCTOR REPLACEMENT	PAGE	JEDEC TYPE NUMBER	RECOMMENDED GENERAL SEMICONDUCTOR REPLACEMENT	PAGE
1N2770		3-9	1N2971B		2-13
1N2770A		3-9	1N2972		2-13
1N2790	1N3156	3-3	1N2972B		2-13
1N2804		2-15	1N2973		2-13
1N2805		2-15	1N2973B		2-13
1N2806		2-15	1N2974		2-13
1N2807		2-15	1N2974B		2-13
1N2808		2-15	1N2975		2-13
1N2809		2-15	1N2975B		2-13
1N2810		2-15	1N2976		2-13
1N2811		2-15	1N2976B		2-13
1N2812		2-15	1N2977		2-13
1N2813		2-15	1N2977B		2-13
1N2814		2-15	1N2978		2-13
1N2815		2-15	1N2979		2-13
1N2816		2-15	1N2979B		2-13
1N2817		2-15	1N2980		2-13
1N2818		2-15	1N2980B		2-13
1N2819		2-15	1N2981B		2-13
1N2820		2-15	1N2982B		2-13
1N2821		2-15	1N2983B		2-13
1N2822		2-15	1N2984B		2-13
1N2823		2-15	1N2985B		2-13
1N2824		2-15	1N2986B		2-13
1N2825		2-15	1N2987B		2-13
1N2826		2-15	1N2988B		2-13
1N2827		2-15	1N2989B		2-13
1N2828		2-15	1N2990B		2-13
1N2829		2-15	1N2991B		2-13
1N2830		2-15	1N2992B		2-13
			1N2993B		2-13
1N2831		2-15	1N2994B		2-13
1N2832		2-15	1N2995B		2-13
1N2833		2-15	1N2996B		2-13
1N2834		2-15	1N2997B		2-13
1N2835		2-15	1N2998B		2-13
1N2836		2-15	1N2999B		2-13
1N2837		2-15	1N3000B		2-13
1N2838		2-15	1N3001B		2-13
1N2839		2-15	1N3002B		2-13
1N2840		2-15	1N3003B		2-13
1N2841		2-17			
1N2842		2-17	1N3004B		2-13
1N2843		2-17	1N3005B		2-13
1N2844		2-17	1N3006B		2-13
1N2845		2-17	1N3007B		2-13
			1N3008B		2-13
1N2846		2-17			
1N2937	1N2996A	2-13	1N3009B		2-13
1N2970		2-13	1N3010B		2-13
1N2970B		2-13	1N3011B		2-13
1N2971		2-13	1N3012B		2-13

Available in JAN and JANTX

**AVAILABLE JEDEC TYPES OR SUGGESTED REPLACEMENTS
DIODES**

JEDEC TYPE NUMBER	RECOMMENDED GENERAL SEMICONDUCTOR REPLACEMENT	PAGE	JEDEC TYPE NUMBER	RECOMMENDED GENERAL SEMICONDUCTOR REPLACEMENT	PAGE
1N3014B		2-13	1N3157A		3-3
1N3015B		2-13	1N3199		3-9
1N3016		2-3	1N3200		3-9
1N3017		2-3	1N3201		3-9
1N3018		2-3	1N3202		3-9
1N3019		2-3	1N3305B		2-16
1N3020		2-3	1N3306B		2-16
1N3021		2-3	1N3307B		2-16
1N3022		2-3	1N3308B		2-16
1N3023		2-3	1N3309B		2-16
1N3024		2-3	1N3310B		2-16
1N3025		2-3	1N3311B		2-16
1N3026		2-3	1N3312B		2-16
1N3027		2-3	1N3313B		2-16
1N3028		2-3	1N3314B		2-16
1N3029		2-3	1N3315B		2-16
1N3030		2-3	1N3316B		2-16
1N3031		2-3	1N3317B		2-16
1N3032		2-3	1N3318B		2-16
1N3033		2-3	1N3319B		2-16
1N3034		2-3	1N3320B		2-16
1N3035		2-3	1N3321B		2-16
1N3036		2-3	1N3322B		2-16
1N3037		2-3	1N3323B		2-16
1N3038		2-3	1N3324B		2-16
1N3039		2-3	1N3325B		2-16
1N3040		2-3	1N3326B		2-16
1N3041		2-3	1N3327B		2-16
1N3042		2-3	1N3328B		2-16
1N3043		2-3	1N3329B		2-16
1N3044		2-3	1N3330B		2-16
1N3045		2-3	1N3331B		2-16
1N3046		2-3	1N3332B		2-16
1N3047		2-3	1N3333B		2-16
1N3048		2-3	1N3334B		2-16
1N3049		2-3	1N3335B		2-16
1N3050		2-3	1N3336B		2-16
1N3051		2-3	1N3337B		2-16
1N3098	1N3046A	2-3	1N3338B		2-16
1N3099	1N3048A	2-3	1N3339B		2-16
1N3100	1N3050A	2-3	1N3340B		2-16
1N3101	1N3051A	2-3	1N3341B		2-16
1N3102	1N3008A	2-13	1N3342B		2-16
1N3103	1N3011A	2-13	1N3343B		2-16
1N3104	1N3014A	2-13	1N3344B		2-16
1N3105	1N3015A	2-13	1N3345B		2-16
1N3112	1N3155A	3-3	1N3346B		2-16
1N3148	1N3155A	3-3	1N3347B		2-16
1N3154A		3-3	1N3348B		2-16
1N3155A		3-3	1N3349B		2-16
1N3156A		3-3	1N3350B		2-16

Available in JAN and JANTX

**AVAILABLE JEDEC TYPES OR SUGGESTED REPLACEMENTS
DIODES**

JEDEC TYPE NUMBER	RECOMMENDED GENERAL SEMICONDUCTOR REPLACEMENT	PAGE	JEDEC TYPE NUMBER	RECOMMENDED GENERAL SEMICONDUCTOR REPLACEMENT	PAGE
1N3433	1N4738	2-5	1N3688		2-4
1N3434	1N4740	2-5	1N3689		2-4
1N3435	1N4742	2-5	1N3690		2-4
1N3436	1N4744	2-5			
			1N3691		2-4
1N3437	1N4746	2-5	1N3692		2-4
1N3438	1N4748	2-5	1N3693		2-4
1N3439	1N4750	2-5	1N3694		2-4
1N3440	1N4752	2-5	1N3695		2-4
1N3441	1N4754	2-5			
			1N3696		2-4
1N3442	1N4756	2-5	1N3697		2-4
1N3443	1N4735	2-5	1N3698		2-4
1N3444	1N4736	2-5	1N3699		2-4
1N3445	1N4738	2-5	1N3700		2-4
1N3446	1N4740	2-5			
			1N3701		2-4
1N3447	1N4742	2-5	1N3702		2-4
1N3448	1N4744	2-5	1N3703		2-4
1N3449	1N4746	2-5	1N3704		2-4
1N3450	1N4748	2-5	1N3705		2-4
1N3451	1N4750	2-5			
			1N3706		2-4
1N3452	1N4751	2-5	1N3707		2-4
1N3453	1N4752	2-5	1N3708		2-4
1N3454	1N4754	2-5	1N3709		2-4
1N3455	1N4756	2-5	1N3710		2-4
1N3456	1N4758	2-5			
			1N3732	1N4733A	2-5
1N3457	1N4760	2-5	1N3763	1N2767A	3-9
1N3458	1N4762	2-5	1N3779		3-4
1N3459	1N4764	2-5	1N3780		3-4
1N3496	1N823	3-1	1N3781		3-4
1N3497	1N825	3-1			
			1N3782		3-4
1N3498	1N827	3-1	1N3783		3-4
1N3499	1N829	3-1	1N3784		3-4
1N3500	1N821	3-1	1N3821		2-3
1N3553	1N821	3-1	1N3822		2-3
1N3580		3-6			
			1N3823		2-3
1N3581		3-6	1N3824		2-3
1N3582		3-6	1N3825		2-3
1N3583		3-6	1N3826		2-3
1N3584		3-6	1N3827		2-3
1N3675		2-4			
			1N3828		2-3
1N3676		2-4	1N3829		2-3
1N3677		2-4	1N3830		2-3
1N3678		2-4	1N3896	1N3998	2-14
1N3679		2-4	1N3949		2-11
1N3680		2-4			
			1N3984		2-11
1N3681		2-4	1N3985		2-11
1N3682		2-4	1N3986		2-11
1N3683		2-4	1N3993		2-14
1N3684		2-4	1N3994		2-14
1N3685		2-4			
			1N3995		2-14
1N3686		2-4	1N3996		2-14
1N3687		2-4	1N3997		2-14

**AVAILABLE JEDEC TYPES OR SUGGESTED REPLACEMENTS
DIODES**

JEDEC TYPE NUMBER	RECOMMENDED GENERAL SEMICONDUCTOR REPLACEMENT	PAGE	JEDEC TYPE NUMBER	RECOMMENDED GENERAL SEMICONDUCTOR REPLACEMENT	PAGE
1N3998		2-14	1N4080		3-10
1N3999		2-14	1N4080A		3-10
1N4000		2-14	1N4081		3-10
1N4010	1N829	3-1	1N4081A		3-10
1N4057		3-10	1N4082		3-10
1N4057A		3-10	1N4082A		3-10
1N4058		3-10	1N4083		3-10
1N4058A		3-10	1N4083A		3-10
1N4059		3-10	1N4084		3-10
1N4059A		3-10	1N4084A		3-10
1N4060		3-10	1N4085		3-10
1N4060A		3-10	1N4085A		3-10
1N4061		3-10	1N4094	1N2624B	3-5
1N4061A		3-10	1N4096	1N4763A	2-5
1N4062		3-10	1N4097	1N4764A	2-5
1N4062A		3-10	1N4098	1N3707	2-4
1N4063		3-10	1N4158	1N4736	2-5
1N4063A		3-10	1N4159	1N4737	2-5
1N4064		3-10	1N4160	1N4738	2-5
1N4064A		3-10	1N4161	1N4739	2-5
1N4065		3-10	1N4162	1N4740	2-5
1N4065A		3-10	1N4163	1N4741	2-5
1N4066		3-10	1N4164	1N4742	2-5
1N4066A		3-10	1N4165	1N4743	2-5
1N4067		3-10	1N4166	1N4744	2-5
1N4067A		3-10	1N4167	1N4745	2-5
1N4068		3-10	1N4168	1N4746	2-5
1N4068A		3-10	1N4169	1N4747	2-5
1N4069		3-10	1N4170	1N4748	2-5
1N4069A		3-10	1N4171	1N4749	2-5
1N4070		3-10	1N4172	1N4750	2-5
1N4070A		3-10	1N4173	1N4751	2-5
1N4071		3-10	1N4174	1N4752	2-5
1N4071A		3-10	1N4175	1N4753	2-5
1N4072		3-10	1N4176	1N4754	2-5
1N4072A		3-10	1N4177	1N4755	2-5
1N4073		3-10	1N4178	1N4756	2-5
1N4073A		3-10	1N4179	1N4757	2-5
1N4074		3-10	1N4180	1N4758	2-5
1N4074A		3-10	1N4181	1N4759	2-5
1N4075		3-10	1N4182	1N4760	2-5
1N4075A		3-10	1N4183	1N4761	2-5
1N4076		3-10	1N4184	1N4762	2-5
1N4076A		3-10	1N4185	1N4763	2-5
1N4077		3-10	1N4186	1N4764	2-5
1N4077A		3-10	1N4187	1N3704	2-4
1N4078		3-10	1N4188	1N3705	2-4
1N4078A		3-10	1N4189	1N3706	2-4
1N4079		3-10	1N4190	1N3707	2-4
1N4079A		3-10	1N4191	1N3708	2-4

**AVAILABLE JEDEC TYPES OR SUGGESTED REPLACEMENTS
DIODES**

JEDEC TYPE NUMBER	RECOMMENDED GENERAL SEMICONDUCTOR REPLACEMENT	PAGE	JEDEC TYPE NUMBER	RECOMMENDED GENERAL SEMICONDUCTOR REPLACEMENT	PAGE
1N4192	1N3709	2-4	1N4260	1N2972	2-13
1N4193	1N3710	2-4	1N4261	1N2973	2-13
1N4194	1N2970	2-13	1N4262	1N2974	2-13
1N4195	1N2971	2-13			
1N4196	1N2972	2-13	1N4263	1N2975	2-13
			1N4264	1N2976	2-13
1N4197	1N2973	2-13	1N4265	1N2977	2-13
1N4198	1N2974	2-13	1N4266	1N2979	2-13
1N4199	1N2975	2-13	1N4267	1N2980	2-13
1N4200	1N2976	2-13			
1N4201	1N2977	2-13	1N4268	1N2982	2-13
			1N4269	1N2984	2-13
1N4202	1N2978	2-13	1N4270	1N2985	2-13
1N4203	1N2979	2-13	1N4271	1N2986	2-13
1N4204	1N2980	2-13	1N4272	1N2988	2-13
1N4205	1N2981	2-13			
1N4206	1N2982	2-13	1N4273	1N2989	2-13
			1N4274	1N2990	2-13
1N4207	1N2983	2-13	1N4275	1N2991	2-13
1N4208	1N2984	2-13	1N4276	1N2992	2-13
1N4209	1N2985	2-13	1N4p77	1N2993	2-13
1N4210	1N2986	2-13			
1N4211	1N2987	2-13	1N4278	1N2995	2-13
			1N4279	1N2997	2-13
1N4212	1N2988	2-13	1N4280	1N2999	2-13
1N4213	1N2989	2-13	1N4281	1N3000	2-13
1N4214	1N2990	2-13	1N4282	1N3001	2-13
1N4215	1N2991	2-13			
1N4216	1N2992	2-13	1N4283	1N3002	2-13
			1N4284	1N3003	2-13
1N4217	1N2993	2-13	1N4285	1N3004	2-13
1N4218	1N2994	2-13	1N4286	1N3005	2-13
1N4219	1N2995	2-13	1N4287	1N3007	2-13
1N4220	1N2996	2-13			
1N4221	1N2997	2-13	1N4288	1N3008	2-13
			1N4289	1N3009	2-13
1N4222	1N2998	2-13	1N4290	1N3011	2-13
1N4223	1N2999	2-13	1N4291	1N3012	2-13
1N4224	1N3000	2-13	1N4292	1N3014	2-13
1N4225	1N3001	2-13			
1N4226	1N3002	2-13	1N4293	1N3015	2-13
			1N4295		3-4
1N4227	1N3003	2-13	1N4295A		3-4
1N4228	1N3004	2-13	1N4296		3-6
1N4229	1N3005	2-13	1N4296A		3-6
1N4230	1N3006	2-13			
1N4231	1N3007	2-13	1N4297		3-7
			1N4297A		3-7
1N4232	1N3008	2-13	1N4297B		3-7
1N4233	1N3009	2-13	1N4298		3-7
1N4234	1N3010	2-13	1N4298A		3-7
1N4235	1N3011	2-13			
1N4236	1N3012	2-13	1N4298B		3-7
			1N4299		3-7
1N4238	1N3014	2-13	1N4299A		3-7
1N4239	1N3015	2-13	1N4299B		3-7
1N4240	1N3996	2-14	1N4300		3-7
1N4241	1N3998	2-14			
			1N4300A		3-7
1N4258	1N2970	2-13	1N4300B		3-7
1N4259	1N2971	2-13	1N4301		3-8

AVAILABLE JEDEC TYPES OR SUGGESTED REPLACEMENTS DIODES

JEDEC TYPE NUMBER	RECOMMENDED GENERAL SEMICONDUCTOR REPLACEMENT	PAGE	JEDEC TYPE NUMBER	RECOMMENDED GENERAL SEMICONDUCTOR REPLACEMENT	PAGE
1N4301A		3-8	1N4403	1N4739	2-5
1N4301B		3-8			
1N4302		3-8	1N4404	1N4740	2-5
1N4302A		3-8	1N4405	1N4741	2-5
1N4302B		3-8	1N4406	1N4742	2-5
1N4303		3-8	1N4407	1N4743	2-5
1N4303A		3-8	1N4408	1N4744	2-5
1N4303B		3-8	1N4409	1N4745	2-5
1N4304		3-8	1N4410	1N4746	2-5
1N4304A		3-8	1N4411	1N4747	2-5
1N4304B		3-8	1N4412	1N4748	2-5
1N4321	LMZ5.1A	2-6	1N4413	1N4749	2-5
1N4323	1N4736	2-5	1N4414	1N4750	2-5
1N4324	1N4737	2-5	1N4415	1N4751	2-5
1N4325	1N4738	2-5	1N4416	1N4752	2-5
1N4326	1N4739	2-5	1N4417	1N4753	2-5
1N4327	1N4740	2-5	1N4418	1N4754	2-5
1N4328	1N4741	2-5	1N4419	1N4755	2-5
1N4329	1N4742	2-5	1N4420	1N4756	2-5
1N4330	1N4743	2-5	1N4421	1N4757	2-5
1N4331	1N4744	2-5	1N4422	1N4758	2-5
1N4332	1N4745	2-5	1N4423	1N4759	2-5
1N4333	1N4746	2-5	1N4424	1N4760	2-5
1N4334	1N4747	2-5	1N4425	1N4761	2-5
1N4335	1N4748	2-5	1N4426	1N4762	2-5
1N4336	1N4749	2-5	1N4427	1N4763	2-5
1N4337	1N4750	2-5	1N4428	1N4764	2-5
1N4338	1N4751	2-5	1N4429	1N3704	2-4
1N4339	1N4752	2-5	1N4430	1N3705	2-4
1N4340	1N4753	2-5	1N4431	1N3706	2-4
1N4341	1N4754	2-5	1N4432	1N3707	2-4
1N4342	1N4755	2-5	1N4433	1N3708	2-4
1N4343	1N4756	2-5	1N4434	1N3709	2-4
1N4344	1N4757	2-5	1N4435	1N3710	2-4
1N4345	1N4758	2-5	1N4460	1N4735A	2-5
1N4346	1N4759	2-5	1N4499	1N4735A	2-5
1N4347	1N4760	2-5	1N4503	1N4752	2-5
1N4348	1N4761	2-5	1N4504	1N5388A	2-8
1N4349	1N4762	2-5	1N4565		3-4
1N4350	1N4763	2-5	1N4565A		3-4
1N4351	1N4764	2-5	1N4566		3-4
1N4352	1N3704	2-4	1N4566A		3-4
1N4353	1N3705	2-4	1N4567		3-4
1N4354	1N3706	2-4	1N4567A		3-4
1N4355	1N3707	2-4	1N4568		3-4
1N4356	1N3708	2-4	1N4568A		3-4
1N4357	1N3709	2-4	1N4569		3-4
1N4358	1N3710	2-4	1N4569A		3-4
1N4400	1N4736	2-5	1N4570		3-4
1N4401	1N4737	2-5	1N4570A		3-4
1N4402	1N4738	2-5	1N4571		3-4
			1N4571A		3-4

**AVAILABLE JEDEC TYPES OR SUGGESTED REPLACEMENTS
DIODES**

JEDEC TYPE NUMBER	RECOMMENDED GENERAL SEMICONDUCTOR REPLACEMENT	PAGE	JEDEC TYPE NUMBER	RECOMMENDED GENERAL SEMICONDUCTOR REPLACEMENT	PAGE
1N4572		3-4	1N4641	1N4749A	2-5
1N4572A		3-4	1N4642	1N4750A	2-5
1N4573		3-4	1N4643	1N4751A	2-5
1N4573A		3-4	1N4644	1N4752A	2-5
1N4574		3-4			
1N4574A		3-4	1N4645	1N4753A	2-5
1N4575		3-4	1N4646	1N4754A	2-5
1N4575A		3-4	1N4647	1N4755A	2-5
1N4576		3-4	1N4648	1N4756A	2-5
1N4576A		3-4	1N4649	1N4728A	2-5
			1N4650	1N4729A	2-5
1N4577		3-4	1N4651	1N4730A	2-5
1N4577A		3-4	1N4652	1N4731A	2-5
1N4578		3-4	1N4653	1N4732A	2-5
1N4578A		3-4	1N4654	1N4733A	2-5
1N4579		3-4			
1N4579A		3-4	1N4655	1N4734A	2-5
1N4580		3-4	1N4656	1N4735A	2-5
1N4580A		3-4	1N4657	1N4736A	2-5
1N4581		3-4	1N4658	1N4737A	2-5
1N4581A		3-4	1N4659	1N4738A	2-5
			1N4660	1N4739A	2-5
1N4582		3-4	1N4661	1N4740A	2-5
1N4582A		3-4	1N4662	1N4741A	2-5
1N4583		3-4	1N4663	1N4742A	2-5
1N4583A		3-4	1N4664	1N4743A	2-5
1N4584		3-4			
1N4584A		3-4	1N4665	1N4744A	2-5
1N4611	1N4576A	3-4	1N4666	1N4745A	2-5
1N4611A	1N4577A	3-4	1N4667	1N4746A	2-5
1N4611B	1N4578A	3-4	1N4668	1N4747A	2-5
1N4611C	1N4579A	3-4	1N4669	1N4748A	2-5
			1N4670	1N4749A	2-5
1N4612	1N4581A	3-4	1N4671	1N4750A	2-5
1N4612A	1N4582A	3-4	1N4672	1N4751A	2-5
1N4612B	1N4583A	3-4	1N4673	1N4752A	2-5
1N4612C	1N4584A	3-4	1N4674	1N4753A	2-5
1N4613	1N4581A	3-4			
			1N4675	1N4754A	2-5
1N4613A	1N4582A	3-4	1N4676	1N4755A	2-5
1N4613B	1N4583A	3-4	1N4677	1N4756A	2-5
1N4613C	1N4584A	3-4	1N4728		2-5
1N4628	1N4736A	2-5	1N4729		2-5
1N4629	1N4737A	2-5			
			1N4730		2-5
1N4630	1N4738A	2-5	1N4731		2-5
1N4631	1N4739A	2-5	1N4732		2-5
1N4632	1N4740A	2-5	1N4733		2-5
1N4633	1N4741A	2-5	1N4734		2-5
1N4634	1N4742A	2-5			
			1N4735		2-5
1N4635	1N4743A	2-5	1N4736		2-5
1N4636	1N4744A	2-5	1N4737		2-5
1N4637	1N4745A	2-5	1N4738		2-5
1N4638	1N4746A	2-5	1N4739		2-5
1N4639	1N4747A	2-5			
			1N4740		2-5
1N4640	1N4748A	2-5	1N4741		2-5

**AVAILABLE JEDEC TYPES OR SUGGESTED REPLACEMENTS
DIODES**

JEDEC TYPE NUMBER	RECOMMENDED GENERAL SEMICONDUCTOR REPLACEMENT	PAGE	JEDEC TYPE NUMBER	RECOMMENDED GENERAL SEMICONDUCTOR REPLACEMENT	PAGE
1N4742		2-5	1N4779		3-2
1N4743		2-5	1N4779A		3-2
1N4744		2-5			
1N4745		2-5	1N4780		3-2
1N4746		2-5	1N4780A		3-2
1N4747		2-5	1N4781		3-2
1N4748		2-5	1N4781A		3-2
1N4749		2-5	1N4782		3-2
			1N4782A		3-2
1N4750		2-5	1N4783		3-2
1N4751		2-5	1N4783A		3-2
1N4752		2-5	1N4784		3-2
1N4753		2-5	1N4784A		3-2
1N4754		2-5			
1N4755		2-5	1N4831	LMZ9.1CA	2-6
1N4756		2-5	1N4832	LMZ10CA	2-6
1N4757		2-5	1N4833	LMZ11CA	2-6
1N4758		2-5	1N4834	LMZ12CA	2-6
1N4759		2-5	1N4835	LMZ13CA	2-6
			1N4836	LMZ15CA	2-6
1N4760		2-5	1N4837	LMZ16CA	2-6
1N4761		2-5	1N4838	LMZ18CA	2-6
1N4762		2-5	1N4839	LMZ20CA	2-6
1N4763		2-5	1N4840	LMZ22CA	2-6
1N4764		2-5			
1N4765		3-1	1N4841	LMZ24CA	2-6
1N4765A		3-1	1N4842	LMZ27CA	2-6
1N4766		3-1	1N4843	LMZ30CA	2-6
1N4766A		3-1	1N4844	LMZ33CA	2-6
1N4767		3-1	1N4845	LMZ36CA	2-6
			1N4846	LMZ39CA	2-6
1N4767A		3-1	1N4847	LMZ43CA	2-6
1N4768		3-1	1N4848	LMZ47CA	2-6
1N4768A		3-1	1N4849	LMZ51CA	2-6
1N4769		3-1	1N4850	LMZ56CA	2-6
1N4769A		3-1			
1N4770		3-1	1N4851	LMZ62CA	2-6
1N4770A		3-1	1N4852	LMZ68CA	2-6
1N4771		3-1	1N4853	LMZ75CA	2-6
1N4771A		3-1	1N4854	LMZ82CA	2-6
1N4772		3-1	1N4855	LMZ91CA	2-6
			1N4856	LMZ100CA	2-6
1N4772A		3-1	1N4857	LMZ110CA	2-6
1N4773		3-1	1N4858	LMZ120CA	2-6
1N4773A		3-1	1N4859	LMZ130CA	2-6
1N4774		3-1	1N4860	LMZ150CA	2-6
1N4774A		3-1			
1N4775		3-2	1N4881	1N4747A	2-5
1N4775A		3-2	1N4882	1N4753A	2-5
1N4776		3-2	1N4883	1N4742A	2-5
1N4776A		3-2	1N4884	1N4747A	2-5
1N4777		3-2	1N4954	1N5342B	2-8
			1N4955	1N5343B	2-8
1N4777A		3-2	1N4956	1N5344B	2-8
1N4778		3-2	1N4957	1N5346B	2-8
1N4778A		3-2	1N4958	1N5347B	2-8

**AVAILABLE JEDEC TYPES OR SUGGESTED REPLACEMENTS
DIODES**

JEDEC TYPE NUMBER	RECOMMENDED GENERAL SEMICONDUCTOR REPLACEMENT	PAGE	JEDEC TYPE NUMBER	RECOMMENDED GENERAL SEMICONDUCTOR REPLACEMENT	PAGE
1N4959	1N5348B	2-8	1N5028		2-7
1N4960	1N5349B	2-8	1N5029		2-7
1N4961	1N5350B	2-8	1N5030		2-7
1N4962	1N5352B	2-8	1N5031		2-7
1N4963	1N5353B	2-8	1N5032		2-7
1N4964	1N5355B	2-8	1N5033		2-7
1N4965	1N5357B	2-8	1N5034		2-7
1N4966	1N5358B	2-8	1N5035		2-7
1N4967	1N5359B	2-8	1N5036		2-7
1N4968	1N5361B	2-8	1N5037		2-7
1N4969	1N5363B	2-8	1N5038		2-7
1N4970	1N5364B	2-8	1N5039		2-7
1N4971	1N5365B	2-8	1N5040		2-7
1N4972	1N5366B	2-8	1N5041		2-7
1N4973	1N5367B	2-8	1N5042		2-7
1N4974	1N5368B	2-8	1N5043		2-7
1N4975	1N5369B	2-8	1N5044		2-7
1N4976	1N5370B	2-8	1N5045		2-7
1N4977	1N5372B	2-8	1N5046		2-7
1N4978	1N5373B	2-8	1N5047		2-7
1N4979	1N5374B	2-8	1N5048		2-7
1N4980	1N5375B	2-8	1N5049		2-7
1N4981	1N5377B	2-8	1N5050		2-7
1N4982	1N5378B	2-8	1N5051		2-7
1N4983	1N5379B	2-8	1N5063	1N4736A	2-5
1N4984	1N5380B	2-8	1N5064	1N4737A	2-5
1N4985	1N5381B	2-8	1N5065	1N4738A	2-5
1N4986	1N5383B	2-8	1N5066	1N4739A	2-5
1N4987	1N5384B	2-8	1N5067	1N4740A	2-5
1N4988	1N5386B	2-8	1N5068	1N4741A	2-5
1N4989	1N5388B	2-8	1N5069	1N4743A	2-5
1N5008		2-7	1N5071	1N4744A	2-5
1N5009		2-7	1N5072	1N4745A	2-5
1N5010		2-7	1N5073	1N4746A	2-5
1N5011		2-7	1N5074	1N4748A	2-5
1N5012		2-7	1N5075	1N4749A	2-5
1N5013		2-7	1N5076	1N4750A	2-5
1N5014		2-7	1N5077	1N4751A	2-5
1N5015		2-7	1N5078	1N4752A	2-5
1N5016		2-7	1N5079	1N4753A	2-5
1N5017		2-7	1N5080	1N4754A	2-5
1N5018		2-7	1N5082	1N4755A	2-5
1N5019		2-7	1N5084	1N4756A	2-5
1N5020		2-7	1N5086	1N4757A	2-5
1N5021		2-7	1N5087	1N4758A	2-5
1N5022		2-7	1N5089	1N4759A	2-5
1N5023		2-7	1N5090	1N4760A	2-5
1N5024		2-7	1N5092	1N4761A	2-5
1N5025		2-7	1N5094	1N4762A	2-5
1N5026		2-7	1N5095	1N4763A	2-5
1N5027		2-7	1N5096	1N3704B	2-4

AVAILABLE JEDEC TYPES OR SUGGESTED REPLACEMENTS DIODES

JEDEC TYPE NUMBER	RECOMMENDED GENERAL SEMICONDUCTOR REPLACEMENT	PAGE	JEDEC TYPE NUMBER	RECOMMENDED GENERAL SEMICONDUCTOR REPLACEMENT	PAGE
1N5097	1N3705B	2-4	1N5365		2-8
1N5098	1N3706B	2-4	1N5366		2-8
1N5099	1N3707B	2-4			
1N5100	1N3708B	2-4	1N5367		2-8
			1N5368		2-8
1N5101	1N3708B	2-4	1N5369		2-8
1N5102	1N3709B	2-4	1N5370		2-8
1N5103	1N3709B	2-4	1N5371		2-8
1N5104	1N3710B	2-4			
1N5118	1N5341B	2-8	1N5372		2-8
			1N5373		2-8
1N5119	1N5367B	2-8	1N5374		2-8
1N5120	1N5368B	2-8	1N5375		2-8
1N5121	1N5369B	2-8	1N5376		2-8
1N5122	1N5371B	2-8			
1N5123	1N5373B	2-8	1N5377		2-8
			1N5378		2-8
1N5124	1N5375B	2-8	1N5379		2-8
1N5125	1N5377B	2-8	1N5380		2-8
1N5126	1N5382B	2-8	1N5381		2-8
1N5127	1N5385B	2-8			
1N5128	1N5387B	2-8	1N5382		2-8
			1N5383		2-8
1N5333		2-8	1N5384		2-8
1N5334		2-8	1N5385		2-8
1N5335		2-8	1N5386		2-8
1N5336		2-8			
1N5337		2-8	1N5387		2-8
			1N5388		2-8
1N5338		2-8	1N5555		1-3
1N5339		2-8	1N5556		1-3
1N5340		2-8	1N5557		1-3
1N5341		2-8			
1N5342		2-8	1N5558		1-3
			1N5559	1N4736	2-5
1N5343		2-8	1N5560	1N4737	2-5
1N5344		2-8	1N5561	1N4738	2-5
1N5345		2-8	1N5562	1N4739	2-5
1N5346		2-8			
1N5347		2-8	1N5563	1N4740	2-5
			1N5564	1N4741	2-5
1N5348		2-8	1N5565	1N4742	2-5
1N5349		2-8	1N5566	1N4743	2-5
1N5350		2-8	1N5567	1N4744	2-5
1N5351		2-8			
1N5352		2-8	1N5568	1N4745	2-5
			1N5569	1N4746	2-5
1N5353		2-8	1N5570	1N4747	2-5
1N5354		2-8	1N5571	1N4748	2-5
1N5355		2-8	1N5572	1N4749	2-5
1N5356		2-8			
1N5357		2-8	1N5573	1N4750	2-5
			1N5574	1N4751	2-5
1N5358		2-8	1N5575	1N4752	2-5
1N5359		2-8	1N5576	1N4753	2-5
1N5360		2-8	1N5577	1N4754	2-5
1N5361		2-8			
1N5362		2-8	1N5578	1N4755	2-5
			1N5579	1N4756	2-5
1N5363		2-8	1N5580	1N4757	2-5
1N5364		2-8	1N5581	1N4758	2-5

Available in JAN and JANTX

AVAILABLE JEDEC TYPES OR SUGGESTED REPLACEMENTS DIODES

JEDEC TYPE NUMBER	RECOMMENDED GENERAL SEMICONDUCTOR REPLACEMENT	PAGE	JEDEC TYPE NUMBER	RECOMMENDED GENERAL SEMICONDUCTOR REPLACEMENT	PAGE
1N5582	1N4759	2-5	1N5663A		1-5
			1N5664A		1-5
1N5583	1N4760	2-5	1N5665A		1-5
1N5584	1N4761	2-5	1N5907		1-7
1N5585	1N4762	2-5	1N5908		1-7
1N5586	1N4763	2-5			
1N5587	1N4764	2-5	1N5913	LMZ3.3	2-6
			1N5914	LMZ3.6	2-6
1N5588	1N3704	2-4	1N5915	LMZ3.9	2-6
1N5589	1N3705	2-4	1N5916	LMZ4.3	2-6
1N5590	1N3706	2-4	1N5917	LMZ4.7	2-6
1N5591	1N3707	2-4			
1N5592	1N3708	2-4	1N5918	LMZ5.1	2-6
			1N5919	LMZ5.6	2-6
1N5593	1N3709	2-4	1N5920	LMZ6.2	2-6
1N5594	1N3710	2-4	1N5921	LMZ6.8	2-6
1N5610	1N5555	1-3	1N5922	LMZ7.5	2-6
1N5611	1N5556	1-3			
1N5612	1N5557	1-3	1N5923	LMZ8.2	2-6
			1N5924	LMZ9.1	2-6
1N5613	1N5558	1-3	1N5925	LMZ10	2-6
1N5629A		1-5	1N5926	LMZ11	2-6
1N5630A		1-5	1N5927	LMZ12	2-6
1N5631A		1-5			
1N5632B		1-5	1N5928	LMZ13	2-6
			1N5929	LMZ15	2-6
1N5633A		1-5	1N5930	LMZ16	2-6
1N5634A		1-5	1N5931	LMZ18	2-6
1N5635A		1-5	1N5932	LMZ20	2-6
1N5636A		1-5			
1N5637A		1-5	1N5933	LMZ22	2-6
			1N5934	LMZ24	2-6
1N5638A		1-5	1N5935	LMZ27	2-6
1N5639A		1-5	1N5936	LMZ30	2-6
1N5640A		1-5	1N5937	LMZ33	2-6
1N5641A		1-5	1N5938	LMZ36	2-6
1N5642A		1-5	1N5939	LMZ39	2-6
			1N5940	LMZ43	2-6
1N5643A		1-5	1N5941	LMZ47	2-6
1N5644A		1-5	1N5942	LMZ51	2-6
1N5645A		1-5			
1N5646A		1-5	1N5943	LMZ56	2-6
1N5647A		1-5	1N5944	LMZ62	2-6
			1N5945	LMZ68	2-6
1N5648A		1-5	1N5946	LMZ75	2-6
1N5649A		1-5	1N5947	LMZ82	2-6
1N5650A		1-5			
1N5651A		1-5	1N5948	LMZ91	2-6
1N5652A		1-5	1N5949	LMZ100	2-6
			1N5950	LMZ110	2-6
1N5653A		1-5	1N5951	LMZ120	2-6
1N5654A		1-5	1N5952	LMZ130	2-6
1N5655A		1-5			
1N5656A		1-5	1N5953	LMZ150	2-6
1N5657A		1-5	1N5954	LMZ160	2-6
			1N5955	LMZ180	2-6
1N5658A		1-5	1N5956	LMZ200	2-6
1N5659A		1-5			
1N5660A		1-5	1N6036A		1-9
1N5661A		1-5	1N6037A		1-9
1N5662A		1-5	1N6038A		1-9

Available in JAN and JANTX

AVAILABLE JEDEC TYPES OR SUGGESTED REPLACEMENTS DIODES

JEDEC TYPE NUMBER	RECOMMENDED GENERAL SEMICONDUCTOR REPLACEMENT	PAGE	JEDEC TYPE NUMBER	RECOMMENDED GENERAL SEMICONDUCTOR REPLACEMENT	PAGE
1N6039A		1-9	1N6146	1N6044	1-9
1N6040A		1-9	1N6146A	1N6044A	1-9
1N6041A		1-9	1N6147	1N6045	1-9
1N6042A		1-9	1N6147A	1N6045A	1-9
1N6043A		1-9	1N6148	1N6046	1-9
1N6044A		1-9	1N6148A	1N6046A	1-9
1N6045A		1-9	1N6149	1N6047	1-9
1N6046A		1-9	1N6149A	1N6047A	1-9
1N6047A		1-9	1N6150	1N6048	1-9
1N6048A		1-9	1N6150A	1N6048A	1-9
1N6049A		1-9	1N6151	1N6049	1-9
1N6050A		1-9	1N6151A	1N6049A	1-9
1N6051A		1-9	1N6152	1N6050	1-9
1N6052A		1-9	1N6152A	1N6050A	1-9
1N6053A		1-9	1N6153	1N6051	1-9
1N6054A		1-9	1N6153A	1N6051A	1-9
1N6055A		1-9	1N6154	1N6052	1-9
1N6056A		1-9	1N6154A	1N6052A	1-9
1N6057A		1-9	1N6155	1N6053	1-9
1N6058A		1-9	1N6155A	1N6053A	1-9
1N6059A		1-9	1N6156	1N6054	1-9
1N6060A		1-9	1N6156A	1N6054A	1-9
1N6061A		1-9	1N6157	1N6055	1-9
1N6062A		1-9	1N6157A	1N6055A	1-9
1N6063A		1-9	1N6158	1N6056	1-9
1N6064A		1-9	1N6158A	1N6056A	1-9
1N6065A		1-9	1N6159	1N6057	1-9
1N6066A		1-9	1N6159A	1N6057A	1-9
1N6067A		1-9	1N6160	1N6058	1-9
1N6068A		1-9	1N6160A	1N6058A	1-9
1N6069A		1-9	1N6161	1N6059	1-9
1N6070A		1-9	1N6161A	1N6059A	1-9
1N6071A		1-9	1N6162	1N6060	1-9
1N6072A		1-9	1N6162A	1N6060A	1-9
1N6138	1N6036	1-9	1N6163	1N6061	1-9
1N6138A	1N6036A	1-9	1N6163A	1N6061A	1-9
1N6139	1N6037	1-9	1N6164	1N6062	1-9
1N6139A	1N6037A	1-9	1N6164A	1N6062A	1-9
1N6140	1N6038	1-9	1N6165	1N6063	1-9
1N6140A	1N6038A	1-9	1N6165A	1N6063A	1-9
1N6141	1N6039	1-9	1N6166	1N6064	1-9
1N6141A	1N6039A	1-9	1N6166A	1N6064A	1-9
1N6142	1N6040	1-9	1N6167	1N6065	1-9
1N6142A	1N6040A	1-9	1N6167A	1N6065A	1-9
1N6143	1N6041	1-9	1N6168	1N6066	1-9
1N6143A	1N6041A	1-9	1N6168A	1N6066A	1-9
1N6144	1N6042	1-9	1N6169	1N6067	1-9
1N6144A	1N6042A	1-9	1N6169A	1N6067A	1-9
1N6145	1N6043	1-9	1N6170	1N6068	1-9
1N6145A	1N6043A	1-9	1N6170A	1N6068A	1-9

Available in JAN and JANTX

**AVAILABLE JEDEC TYPES OR SUGGESTED REPLACEMENTS
DIODES**

JEDEC TYPE NUMBER	RECOMMENDED GENERAL SEMICONDUCTOR REPLACEMENT	PAGE	JEDEC TYPE NUMBER	RECOMMENDED GENERAL SEMICONDUCTOR REPLACEMENT	PAGE
1N6171	1N6069	1-9	1N6286A	1.5KE43A	1-12
1N6171A	1N6069A	1-9	1N6287	1.5KE47	1-12
1N6172	1N6070	1-9	1N6287A	1.5KE47A	1-12
1N6172A	1N6070A	1-9	1N6288	1.5KE51	1-12
1N6173	1N6071	1-9	1N6288A	1.5KE51A	1-12
1N6173A	1N6071A	1-9	1N6289	1.5KE56	1-12
1N6267	1.5KE6.8	1-12	1N6289A	1.5KE56A	1-12
1N6267A	1.5KE6.8A	1-12	1N6290	1.5KE62	1-12
1N6268	1.5KE7.5	1-12	1N6290A	1.5KE62A	1-12
1N6268A	1.5KE7.5A	1-12	1N6291	1.5KE68	1-12
1N6269	1.5KE8.2	1-12	1N6291A	1.5KE68A	1-12
1N6269A	1.5KE8.2A	1-12	1N6292	1.5KE75	1-12
1N6270	1.5KE9.1	1-12	1N6292A	1.5KE75A	1-12
1N6270A	1.5KE9.1A	1-12	1N6293	1.5KE82	1-12
1N6271	1.5KE10	1-12	1N6293A	1.5KE82A	1-12
1N6271A	1.5KE10A	1-12	1N6294	1.5KE91	1-12
1N6272	1.5KE11	1-12	1N6294A	1.5KE91A	1-12
1N6272A	1.5KE11A	1-12	1N6295	1.5KE100	1-12
1N6273	1.5KE12	1-12	1N6295A	1.5KE100A	1-12
1N6273A	1.5KE12A	1-12	1N6296	1.5KE110	1-12
1N6274	1.5KE13	1-12	1N6296A	1.5KE110A	1-12
1N6274A	1.5KE13A	1-12	1N6297	1.5KE120	1-12
1N6275	1.5KE15	1-12	1N6297A	1.5KE120A	1-12
1N6275A	1.5KE15A	1-12	1N6298	1.5KE130	1-12
1N6276	1.5KE16	1-12	1N6298A	1.5KE130A	1-12
1N6276A	1.5KE16A	1-12	1N6299	1.5KE150	1-12
1N6277	1.5KE18	1-12	1N6299A	1.5KE150A	1-12
1N6277A	1.5KE18A	1-12	1N6300	1.5KE160	1-12
1N6278	1.5KE20	1-12	1N6300A	1.5KE160A	1-12
1N6278A	1.5KE20A	1-12	1N6301	1.5KE170	1-12
1N6279	1.5KE22	1-12	1N6301A	1.5KE170A	1-12
1N6279A	1.5KE22A	1-12	1N6302	1.5KE180	1-12
1N6280	1.5KE24	1-12	1N6302A	1.5KE180A	1-12
1N6280A	1.5KE24A	1-12	1N6303	1.5KE200	1-12
1N6281	1.5KE27	1-12	1N6303A	1.5KE200A	1-12
1N6281A	1.5KE27A	1-12		1.5KE220	1-12
1N6282	1.5KE30	1-12		1.5KE220A	1-12
1N6282A	1.5KE30A	1-12		1.5KE250*	1-12
1N6283	1.5KE33	1-12		1.5KE250A*	1-12
1N6283A	1.5KE33A	1-12		1.5KE300*	1-12
1N6284	1.5KE36	1-12		1.5KE300A*	1-12
1N6284A	1.5KE36A	1-12		1.5KE350*	1-12
1N6285	1.5KE39	1-12		1.5KE350A*	1-12
1N6285A	1.5KE39A	1-12		1.5KE400*	1-12
1N6286	1.5KE43	1-12		1.5KE400A*	1-12

**AVAILABLE JEDEC TYPES OR SUGGESTED REPLACEMENTS
TRANSISTORS**

JEDEC TYPE NUMBER	RECOMMENDED GENERAL SEMICONDUCTOR REPLACEMENT	PAGE	JEDEC TYPE NUMBER	RECOMMENDED GENERAL SEMICONDUCTOR REPLACEMENT	PAGE
2N497	2N4238	4-3	2N1511	2N4913	4-7
2N497A	2N4238	4-3	2N1512	2N4914	4-7
2N498	2N4239	4-3	2N1513	2N4913	4-7
2N498A	2N5681	4-3	2N1514	2N4914	4-7
2N545		4-3			
2N546		4-3	2N1616		4-6
2N547		4-3	2N1616A		4-8
2N548		4-3	2N1617		4-6
2N549		4-3	2N1617A		4-8
2N550		4-3	2N1618		4-6
			2N1618A		4-8
2N656	2N4238	4-3	2N1647		4-5
2N656A	2N4238	4-3	2N1648		4-5
2N657	2N5681	4-3	2N1649		4-5
2N657A	2N5681	4-3	2N1650		4-5
2N1047	2N4912	4-3			
			2N1679	2N5335	4-5
2N1047A	2N4912	4-3	2N1680	2N5334	4-5
2N1047B	2N4912	4-3	2N1700		4-3
2N1049	2N4912	4-3	2N1701	2N4910	4-3
2N1049A	2N4912	4-3	2N1702		4-3
2N1049B	2N4912	4-3			
			2N1714		4-3
2N1049C	2N4912	4-3	2N1715		4-3
2N1052		4-3	2N1716		4-3
2N1054		4-3	2N1717		4-3
2N1055		4-3	2N1718	2N3420	4-21
2N1067	2N4237	4-3			
			2N1719	2N3767	4-5
2N1068	2N4237	4-3	2N1720	2N3420	4-21
2N1072	2N3766	4-5	2N1721	2N3767	4-5
2N1080	2N4914	4-7	2N1722	2N5427	4-8
2N1092	2N4237	4-3	2N1723	2N5428	4-8
2N1116		4-3			
			2N1724		4-6
2N1117		4-3	2N1724A		4-6
2N1208		4-6	2N1725		4-6
2N1209		4-6	2N1841	2N5334	4-5
2N1212		4-6	2N1886	2N2892	4-6
2N1250	2N4914	4-7			
			2N1894	2N4238	4-3
2N1252		4-3	2N1895	2N4239	4-3
2N1253		4-3	2N1896	2N5336	4-7
2N1260	2N5479	4-8	2N1897	2N5336	4-7
2N1421	2N5477	4-8	2N1898	2N5338	4-7
2N1422	2N5477	4-8			
			2N1899	2N4002	4-29
2N1423	2N5477	4-8	2N1901	2N4002	4-29
2N1424	2N5477	4-8	2N1983		4-3
2N1445		4-3	2N1984		4-3
2N1479	2N4237	4-3	2N1985		4-3
2N1480	2N4238	4-3			
			2N2008	2N2987	4-3
2N1481	2N4237	4-3	2N2017	2N2989	4-3
2N1482	2N4238	4-3	2N2018		4-3
2N1487	2N4913	4-7	2N2019		4-3
2N1488	2N4914	4-7	2N2034	2N4238	4-3
2N1489	2N4913	4-7			
			2N2101		4-5
2N1490	2N4914	4-7	2N2102	2N4239	4-3

**AVAILABLE JEDEC TYPES OR SUGGESTED REPLACEMENTS
TRANSISTORS**

JEDEC TYPE NUMBER	RECOMMENDED GENERAL SEMICONDUCTOR REPLACEMENT	PAGE	JEDEC TYPE NUMBER	RECOMMENDED GENERAL SEMICONDUCTOR REPLACEMENT	PAGE
2N2123	2N4002	4-29	2N2849-2		4-5
2N2124	2N4002	4-29	2N2850		4-5
2N2130	2N4002	4-29	2N2850-1		4-5
2N2131	2N4002	4-29			
			2N2850-2		4-5
2N2150		4-3	2N2851		4-5
2N2151		4-3	2N2851-1		4-5
2N2196	2N2987	4-3	2N2851-2		4-5
2N2197	2N2987	4-3	2N2852		4-5
2N2201	2N5681	4-3			
			2N2852-1		4-5
2N2202	2N5681	4-3	2N2852-2		4-5
2N2203	2N5681	4-3	2N2853		4-5
2N2204	2N5681	4-3	2N2853-1		4-5
2N2304	2N4910	4-3	2N2853-2		4-5
2N2308	2N4912	4-3			
			2N2854		4-5
2N2339	2N4910	4-3	2N2854-1		4-5
2N2340	2N4237	4-3	2N2854-2		4-5
2N2341	2N5334	4-5	2N2855		4-5
2N2343	2N5334	4-5	2N2855-1		4-5
2N2383	2N4914	4-7			
			2N2855-2		4-5
2N2384	2N4914	4-7	2N2856		4-5
2N2405	2N2987	4-3	2N2856-1		4-5
2N2472	2N2987	4-3	2N2856-2		4-5
2N2594	2N5336	4-7	2N2858	2N5335	4-5
2N2611	2N3766	4-5			
			2N2859	2N5338	4-7
2N2632		4-6	2N2866	2N5477	4-8
2N2633		4-6	2N2867	2N5478	4-8
2N2634		4-6	2N2877		4-19
2N2655	2N5681	4-3	2N2878		4-19
2N2657		4-6			
			2N2879		4-19
2N2658		4-6	2N2880		4-19
2N2697	2N5478	4-8	2N2890		4-6
2N2698	2N5478	4-8	2N2891		4-6
2N2811		4-9	2N2892		4-6
2N2812		4-9			
			2N2893		4-6
2N2813		4-9	2N2983		4-5
2N2814		4-9	2N2984		4-5
2N2815		4-10	2N2985		4-5
2N2816		4-10	2N2986		4-5
2N2817		4-13			
			2N2987		4-3
2N2818		4-13	2N2988		4-3
2N2819		4-10	2N2989		4-3
2N2820		4-10	2N2990		4-3
2N2821		4-10	2N2991	2N3420	4-21
2N2822		4-10			
			2N2992	2N3767	4-5
2N2823		4-11	2N2993	2N3420	4-21
2N2824		4-11	2N2994	2N3767	4-5
2N2825		4-11	2N3138	2N5477	4-8
2N2828	2N3998	4-27	2N3140	2N5477	4-8
2N2829	2N3998	4-27			
			2N3142	2N5477	4-8
2N2849		4-5	2N3144	2N5477	4-8
2N2849-1		4-5	2N3220	2N5477	4-8

AVAILABLE JEDEC TYPES OR SUGGESTED REPLACEMENTS TRANSISTORS

JEDEC TYPE NUMBER	RECOMMENDED GENERAL SEMICONDUCTOR REPLACEMENT	PAGE	JEDEC TYPE NUMBER	RECOMMENDED GENERAL SEMICONDUCTOR REPLACEMENT	PAGE
2N3221	2N5477	4-8	2N4002		4-29
2N3222	2N5477	4-8	2N4003		4-29
2N3223	2N5479	4-8	2N4070		4-31
2N3226		4-6	2N4071		4-33
2N3262		4-3	2N4075		4-5
2N3265		4-10	2N4076		4-5
2N3266		4-10	2N4111		4-6
2N3418		4-21	2N4112		4-6
2N3419		4-21	2N4113		4-6
2N3420		4-21	2N4114		4-6
2N3421		4-21	2N4115		4-6
2N3464	2N5334	4-5	2N4116		4-6
2N3469		4-6	2N4150		4-35
2N3487	2N5313	4-9	2N4210		4-10
2N3488	2N5315	4-9	2N4211		4-10
2N3490	2N5313	4-9	2N4225	2N5334	4-5
2N3491	2N5315	4-9	2N4226	2N5334	4-5
2N3506		4-23	2N4231		4-5
2N3507		4-23	2N4232		4-5
2N3583	2N5660	4-59	2N4233		4-5
2N3585	2N4240	4-37	2N4237		4-3
2N3597		4-10	2N4238		4-3
2N3598		4-10	2N4239		4-3
2N3599		4-10	2N4240		4-37
2N3665	2N5335	4-5	2N4271	2N5682	4-3
2N3675		4-5	2N4272	2N5682	4-3
2N3676		4-5	2N4300		4-4
2N3738		4-25	2N4301		4-9
2N3739		4-25	2N4395		4-7
2N3744		4-6	2N4396		4-7
2N3745		4-6	2N4862	2N4863	4-39
2N3746		4-6	2N4863		4-39
2N3747		4-6	2N4864		4-39
2N3748		4-6	2N4877		4-5
2N3749		4-6	2N4910		4-3
2N3750		4-6	2N4911		4-3
2N3751		4-6	2N4912		4-3
2N3752		4-6	2N4913		4-7
2N3766		4-5	2N4914		4-7
2N3767		4-5	2N4915		4-7
2N3852		4-6	2N4932	2N5477	4-8
2N3853		4-6	2N4933	2N5477	4-8
2N3878		4-8	2N5038	2N6340	4-93
2N3879		4-8	2N5039	2N6338	4-91
2N3945	2N5334	4-5	2N5048	2N5542	4-57
2N3996		4-27	2N5049	2N5313	4-9
2N3997		4-27	2N5050		4-41
2N3998		4-27	2N5051		4-41
2N3999		4-27	2N5052		4-41
2N4000		4-3	2N5074		4-43
2N4001		4-3	2N5075		4-45

Available in JAN and JANTX

**AVAILABLE JEDEC TYPES OR SUGGESTED REPLACEMENTS
TRANSISTORS**

JEDEC TYPE NUMBER	RECOMMENDED GENERAL SEMICONDUCTOR REPLACEMENT	PAGE	JEDEC TYPE NUMBER	RECOMMENDED GENERAL SEMICONDUCTOR REPLACEMENT	PAGE
2N5076		4-45	2N5602		4-4
			2N5604		4-4
2N5077		4-45			
2N5148		4-47	2N5606		4-7
2N5150		4-47	2N5608		4-7
2N5152		4-7	2N5610		4-7
2N5154		4-7	2N5612		4-7
			2N5658		4-9
2N5202		4-5			
2N5218		4-49	2N5659		4-9
2N5237		4-51	2N5660		4-59
2N5239		4-7	2N5661		4-59
2N5288		4-9	2N5662		4-61
			2N5663		4-61
2N5289		4-9			
2N5313		4-9	2N5664		4-63
2N5315		4-9	2N5665		4-63
2N5317		4-9	2N5666		4-65
2N5319		4-9	2N5667		4-65
			2N5681		4-3
2N5320		4-4			
2N5321		4-4	2N5682		4-3
2N5334		4-5	2N5729		4-7
2N5335		4-5	2N5730		4-9
2N5336		4-7	2N5731		4-10
			2N5732		4-67
2N5337		4-7			
2N5338		4-7	2N5733		4-11
2N5339		4-7	2N5734		4-11
2N5346		4-8	2N5854		4-9
2N5347		4-8	2N6032		4-69
			2N6033		4-71
2N5348		4-8			
2N5349		4-8	2N6077		4-73
2N5387		4-53	2N6078		4-73
2N5388		4-53	2N6079		4-75
2N5389		4-55	2N6215		4-11
			2N6232		4-77
2N5412		4-9			
2N5427		4-8	2N6233		4-79
2N5428		4-8	2N6234		4-79
2N5429		4-8	2N6235		4-79
2N5430		4-8	2N6274		4-81
2N5477		4-8	2N6275		4-83
2N5478		4-8	2N6276		4-83
2N5479		4-8	2N6277		4-85
2N5480		4-8	2N6278		4-87
2N5487		4-7	2N6279		4-89
2N5487-1		4-7	2N6280		4-89
2N5488		4-7	2N6281		4-89
2N5488-1		4-7	2N6338		4-91
2N5541		4-57	2N6339		4-91
2N5542		4-57	2N6340		4-93
2N5552		4-9	2N6341		4-93
2N5552-1		4-9	2N6653		4-95
2N5598		4-4	2N6654		4-95
2N5600		4-4	2N6655		4-95

TRANSZORB DEFINITIONS AND SPECIFICATIONS

TransZorbs are PN Silicon transient voltage suppressors that are characterized by their phenomenal surge handling capabilities, extremely fast response time (1×10^{-12} seconds), and low series resistance (R_{on}). Unlike the zener diode whose function is voltage regulation, the TransZorb is designed, manufactured, specified and tested for transient suppression.

When selecting a TransZorb, first determine the transient condition or the source of the pulse for each application. Specify maximum DC or AC peak voltage with tolerance. This maximum voltage level should be equal to or less than the reverse standoff voltage of the TransZorb.

Consider what is the minimum and maximum voltage for a given circuit.

Because of the temperature coefficient, the minimum clamping voltage (V_C) should be considered as the reverse standoff voltage (V_R) when operating at the extreme temperature of -65°C .

The maximum clamping voltage (V_C) is a desired voltage to provide adequate protection for a circuit or component.

Determine the proper device according to the peak pulse power. This can be accomplished in knowing the source impedance and the maximum transient voltage. Once the maximum peak pulse current (I_{pp}) is known (and if its value is less than the maximum I_{pp}), use the maximum clamping voltage (V_C) to calculate power for worst case design for most applications.

The TransZorb can be used in applications where induced lightning on rural or remote transmission lines present a hazard to the electronic circuitry. (Reference: REA Specification P.E. 60)

TransZorbs have proven to be effective in Airborne Avionics and Controls, Mobile Communications equipment, Computer power supplies, Numerically Controlled Machinery, and in many other applications where inductive and switching transients are present.

With their fast response times and low clamping factors, TransZorbs can protect Integrated Circuits, MOS devices, Hybrids, and other voltage-sensitive components. TransZorbs can also be used in series or parallel to increase the peak power ratings.

TransZorbs have been evaluated for susceptibility to neutron and gamma radiation. Neutron flux irradiation of 1.4×10^{13} neutrons/cm and cumulative gamma dosage of 2×10^7 rad(Si) have been applied to the TransZorb without causing appreciable parameter changes.

They have also been proven effective for EMP suppression. For actual test results and applications send for the EMP report #AD 909267L, at the Defense Documentation Center, Alexandria, Virginia 22314.

Because of the unpredictable nature of transients and the variation of the impedance with respect to these transients, impedance is not specified as a parametric value. However, a minimum voltage (BV) at low current conditions and a maximum clamping voltage (V_C) at a maximum peak pulse current is specified.

The maximum observed clamping voltage (V_C) is approximately the same for all pulses shown within the limits of the curve in Figure 1. In some instances, the thermal effect may be responsible for 50 to 70% of the observed change in voltage when subjected to high current pulses or severe duty cycles. The maximum reverse leakage current must be doubled for voltage types up to 11 volts for bipolar devices.

Figure 3 shows a typical power derating curve for TransZorbs when derated above 25°C . Clamping voltage vs. varying peak pulse current curves at one millisecond, extended power curves vs. time, and detailed technical data sheets are available.

ABBREVIATIONS AND SYMBOLS

VR Stand Off Voltage: Applied Reverse Voltage to assure a nonconductive condition. (See Note 1)

BV(min) This is the minimum Breakdown Voltage the device will exhibit and is used to assure that conduction does not occur prior to this voltage level at 25°C .

VC(max) Maximum Clamping Voltage. The maximum peak voltage appearing across the TransZorb when subjected to the peak pulse current in a one millisecond time interval. The peak pulse voltages are the combination of voltage rise due to both the series resistance and thermal rise.

I_{PP} Peak Pulse Current - See Figure 2

PP Peak Pulse Power

IR Reverse Leakage

Note 1:

A TransZorb is normally selected according to the reverse "Stand Off Voltage" (VR) which should be equal to or greater than the DC or continuous peak operating voltage level.

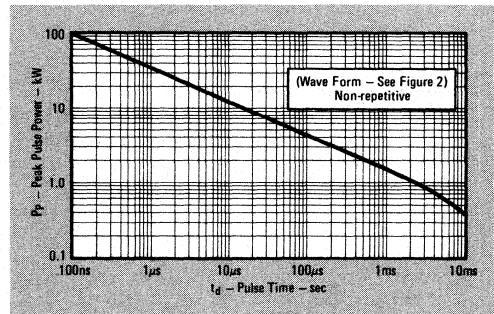
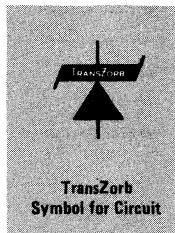

FIGURE 1 - Peak Pulse Power vs. Pulse Time

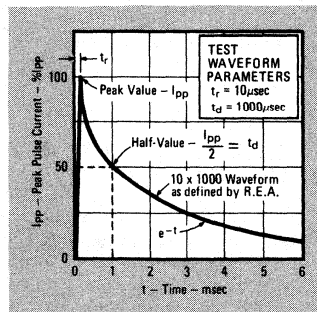

FIGURE 2 - Pulse Wave Form (10 x 1000)

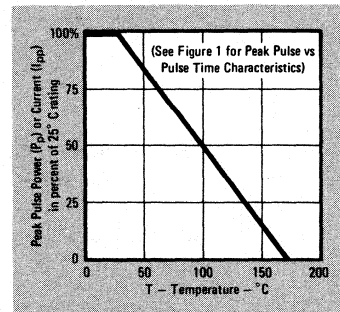
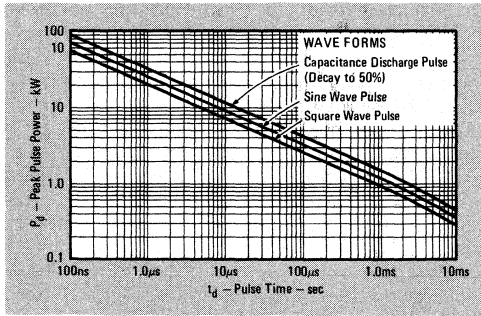
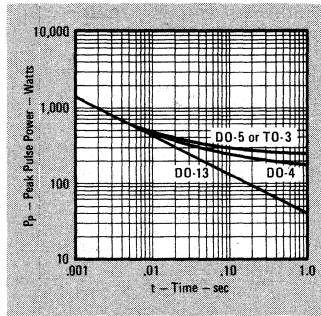

FIGURE 3 - Power or Current vs. Temperature Derating Curve

TRANSORB APPLICATION CURVES FOR 1.5K AND 1.5KE SERIES



Peak Pulse Power vs. Pulse Time



Peak Pulse Power vs. Pulse Time (Extended)

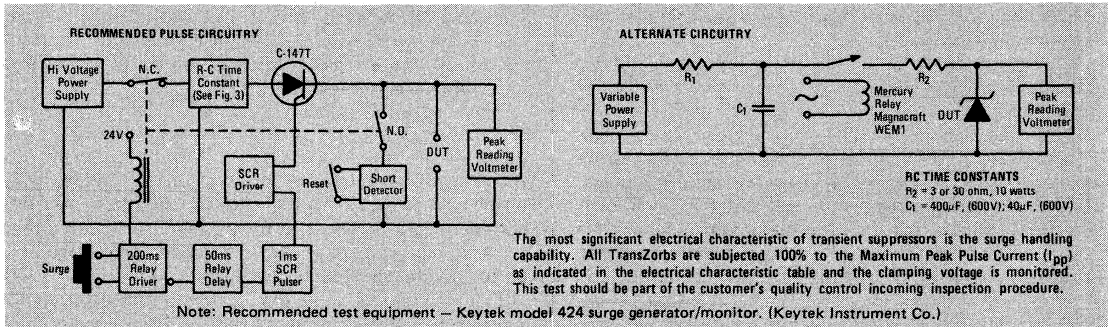
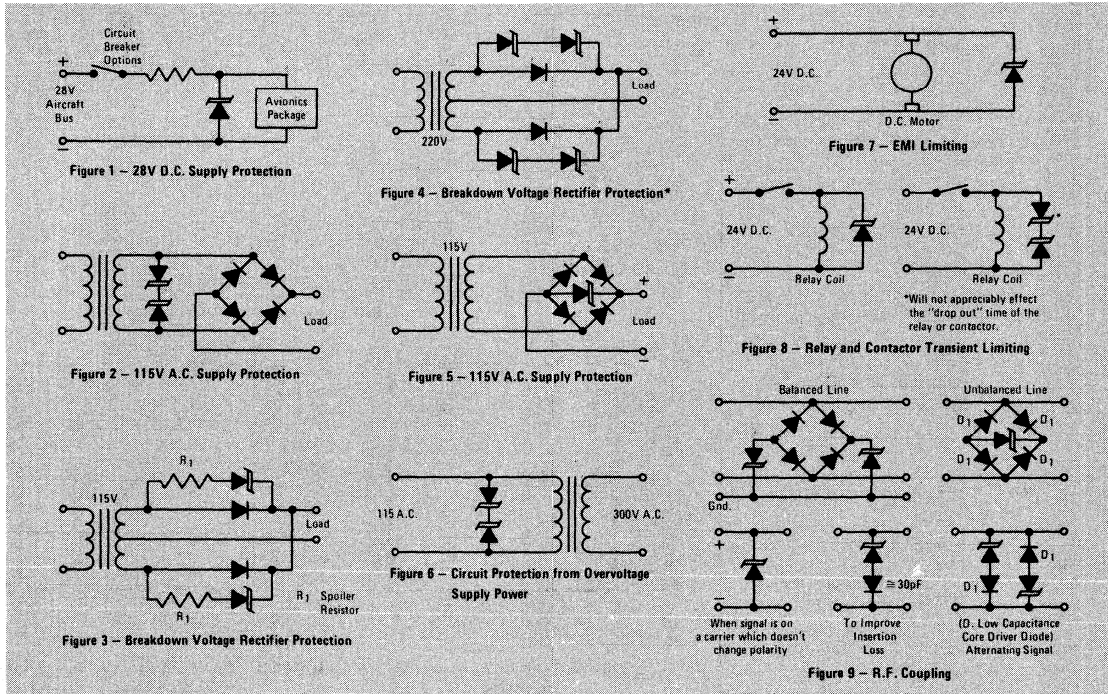

FIGURE 4 - Capacitor Discharge Circuit for Testing TransZorbs

TYPICAL TRANSORB APPLICATIONS





**GENERAL
SEMICONDUCTOR
INDUSTRIES, INC.**

TRANSZORB[®]
TRANSIENT VOLTAGE
SUPPRESSORS
1N5555
THRU
1N5558

1

TRANSZORB[®]S

DESCRIPTION

. . . a series of Silicon Transient Suppressors for use primarily in Airborne Equipment where large voltage transients endanger voltage sensitive components. The TransZorb meets all requirements of MIL-S-19500/434. JAN & JANTX units are available.

These devices were designed with MIL-STD-704A (Characteristics and Utilization of Aircraft Electric Power) as the controlling specification. In most cases the source impedance is not specified and can vary from .2 ohm to 150 ohms. The TransZorb will operate with a minimum of 1 ohm source impedance. If the source impedance is known to be less, either an inductive or resistive load should be added in series to limit the current flow.

The reasonable assumption must be made, that the energy level of the voltage transient is not infinite and thus will decay when shunted by the TransZorb at a rate equal to or greater than that which is specified in Figure 2, Page 1-1. In case of a severe, abnormal transient beyond the maximum ratings, the TransZorb will initially fail "short" thus tripping the system's circuit breaker or fuse while protecting the entire circuit.

Because the response time of the TransZorb's clamping action is effectively instantaneous (better than 1×10^{-12} sec), they can protect Integrated Circuits, MOS Fets, Hybrids and other voltage sensitive semiconductors and components. The TransZorbs are available in a complete voltage range from 5.0 volts to 200 volts. They can also be used in series or parallel to increase the peak power ratings. Due to the high surge capability and fast response, they have been proven effective EMP suppressors.

- MIL qualified per MIL-S-19500/434
- Designed for DC applications

MAXIMUM RATINGS

- 1500 Watts of Peak Pulse Power dissipation at 25°C
- $t_{clamping}$ (0 volts to BV min): Less than 1×10^{-12} seconds
- Operating and Storage temperatures: -65° to +175°C
- Forward surge rating: 200 amps, 1/120 second at 25°C
- Steady State power dissipation: 1.0 watt
- Duty cycle: .01%

MECHANICAL CHARACTERISTICS

- Standard DO-13 package — glass and metal hermetically sealed
- Weight: 1.5 grams (approximate)
- Positive terminal marked with band
- Body marked with Logo * and type number
- Standard polarity — cathode to case

Peak Pulse Power vs Pulse Time. Figure 1, Page 1-1
Pulse Wave Form. Figure 2, Page 1-1
Power-Temperature Derating Curve. Figure 3, Page 1-1

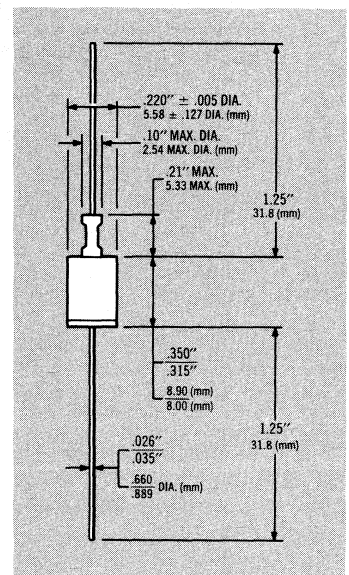
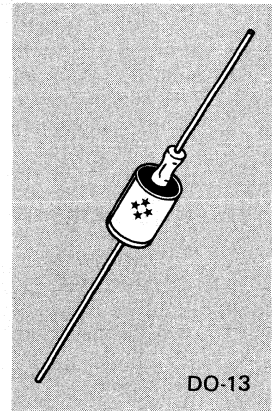

ELECTRICAL CHARACTERISTICS @ 25°C

GENERAL SEMICONDUCTOR PART NUMBER	JEDEC TYPE NUMBER **	REVERSE STAND-OFF VOLTAGE (Note 1)	MAXIMUM REVERSE LEAKAGE	MINIMUM BREAKDOWN VOLTAGE	MAXIMUM CLAMPING VOLTAGE	MAXIMUM PEAK PULSE CURRENT	MAXIMUM TEMPERATURE COEFFICIENT
		V_R VOLTS	@ V_R I_R μA	@ 1 mA BV	@ I_{PP} V_C VOLTS	(Fig. 2) I_{PP} A	
704-34A	1N5555	30.5	5	33.0	47.5	32	+ .093
704-45A	1N5556	40.3	5	43.7	63.5	24	+ .094
704-56A	1N5557	49.0	5	54.0	78.5	19	+ .096
704-190A	1N5558	175.0	5	191.0	265.0	5.7	+ .100

Available in JAN & JANTX per MIL-S-19500/434

V_f @ 100 amps peak, 8.3 msec sine wave = 3.5 volts maximum.

**Bipolar TransZorbs are available for certain applications.

Note 1: A TransZorb is normally selected according to the reverse "Stand Off Voltage" (V_R) which should be equal to or greater than the DC or continuous peak operating voltage level.

TYPICAL TEST CIRCUITS FOR SYSTEM CAPABILITY

600V TRANSIENT TEST

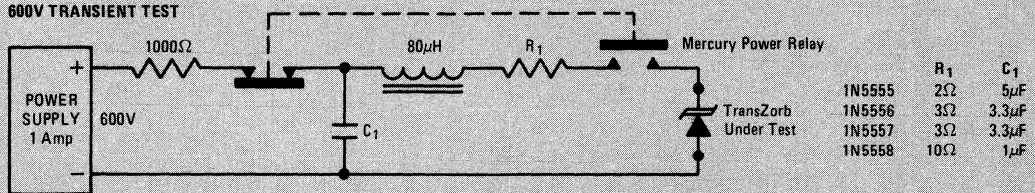

80V OVERVOLTAGE TEST

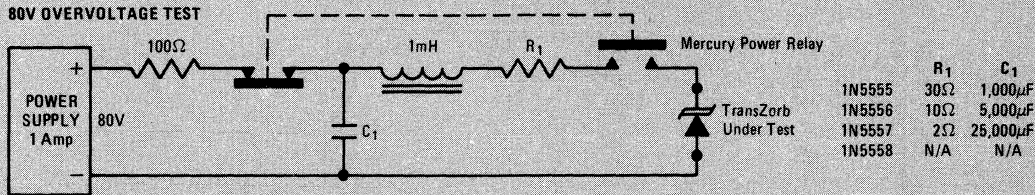

For applications requiring higher surge devices, refer to pages 1-19 and 1-20, Part Number 60KS200C for equivalent AC conditions; or pages 1-21 and 1-22, Part Number 704-15K36 or 704-15K36T for equivalent DC conditions.



**GENERAL
SEMICONDUCTOR
INDUSTRIES, INC.**

TRANSZORB
TRANSIENT VOLTAGE
SUPPRESSORS

1N5629
THRU
1N5665A

1

TRANSZORBS

DESCRIPTION

This specification sheet defines a series of Silicon Transient Suppressors used in applications where large voltage transients can permanently damage voltage-sensitive components. The TransZorb is packaged in a hermetically sealed, glass-to-metal package. JAN and JANTX TransZorbs qualified to MIL-S-19500/500 are also available.

TransZorbs are characterized by their high surge capability, extremely fast response time, and low impedance, (R_{on}). Because of the unpredictable nature of transients and the variation of the impedance with respect to these transients, impedance per se is not specified as a parametric value. However, a minimum voltage at low current conditions (BV) and a maximum clamping voltage (V_C) at a maximum peak pulse current is specified. In addition, a maximum clamping ratio is indicated. In some instances the thermal effect (see V_C Clamping Voltage) may be responsible for 50% to 70% of the observed voltage differential when subjected to high current pulses or severe duty cycles thus making a maximum impedance specification insignificant. In case of a severe current overload or abnormal transient beyond the maximum ratings, the TransZorb will initially fail "short" thus tripping the systems' circuit breaker or fuse while protecting the entire circuit. Curves depicting clamping voltage vs. various current pulses are available from the factory. Extended power curves vs. pulse time are also available.

The TransZorb has a peak pulse power rating of 1500 watts for one millisecond and therefore can be used in applications where induced lightning on rural or remote transmission lines presents a hazard to electronic circuitry (ref: R.E.A. specification P.E.60). The response time of TransZorb clamping action is theoretically instantaneous (1×10^{-12} sec); therefore, they can protect integrated circuits, MOS devices, Hybrids, and other voltage-sensitive semiconductors and components. TransZorbs can also be used in series or parallel to increase the peak power ratings.

This series of devices has been proven very effective as EMP Suppressors. For the actual test results and application send for report number AD9092661. This specification sheet is only one of many series of Transient Voltage Suppressors available from General Semiconductor Industries.

- 1500 watts peak power dissipation
- Available in ranges from 6.8V to 200V.
- DO-13 hermetically sealed package

MAXIMUM RATINGS

- 1500 Watts of Peak Pulse Power dissipation at 25°C
- $t_{clamping}$ (0 volts to BV min): Less than 1×10^{-12} seconds
- Operating and Storage Temperatures: -65° to +175° C
- Forward surge rating: 200 amps, 1/120 second at 25° C
- Steady State power dissipation: 1 watt
- Repetition rate (duty cycle): .01%

MECHANICAL CHARACTERISTICS

- Standard DO-13 package — glass and metal hermetically sealed
- Weight: 1.5 grams (approximate)
- Positive terminal marked with band
- Standard Polarity — Cathode to Case
- Body marked with Logo *+ and type number

ELECTRICAL CHARACTERISTICS

- Clamping Factor: 1.33 @ Full rated power
1.20 @ 50% rated power

Clamping Factor: The ratio of the actual V_C (Clamping Voltage) to the BV (Breakdown Voltage) as measured on a specific device. (See Figure 3 for test pulse wave shape.)

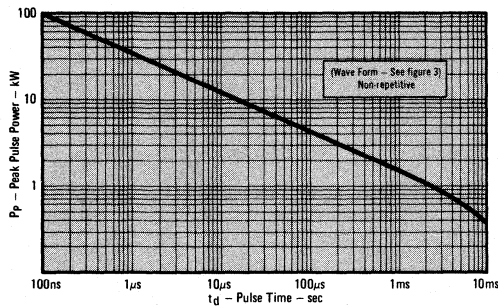
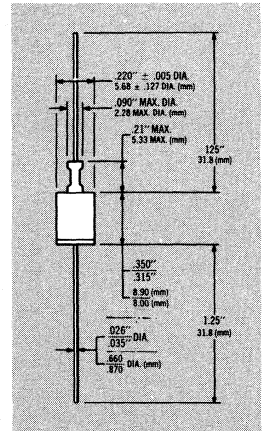
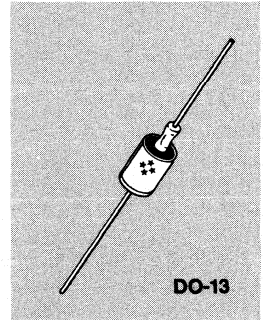

FIGURE 1 — Peak Pulse Power vs Pulse Time

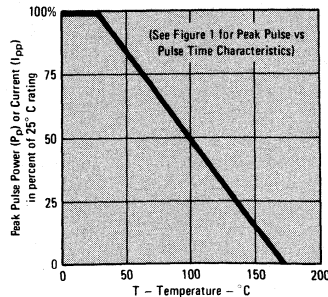

FIGURE 2 Derating Curve

JEDEC TYPE NUMBER	GENERAL SEMICONDUCTOR PART NUMBER	REVERSE STAND-OFF VOLTAGE (Note 1)	BREAKDOWN VOLTAGE			MAXIMUM CLAMPING VOLTAGE @ I _{PP} (1 mSEC)	MAXIMUM REVERSE LEAKAGE @ V _R	MAXIMUM PEAK PULSE CURRENT (Fig. 2)	MAXIMUM TEMPERATURE COEFFICIENT OF BV
		V _R VOLTS	BV VOLTS	@ mA	I _T mA	V _C VOLTS	I _R μA	I _{PP} A	%/°C
1N5629	1.5K6.8	5.50	6.12 - 7.48	10	10.8	1000	139	.057	
1N5629A	1.5K6.8A	5.80	6.45 - 7.14	10	10.5	1000	143	.057	
1N5630	1.5K7.5	6.05	6.75 - 8.25	10	11.7	500	128	.061	
1N5630A	1.5K7.5A	6.40	7.13 - 7.88	10	11.3	500	132	.061	
1N5631	1.5K8.2	6.63	7.38 - 9.02	10	12.5	200	120	.065	
1N5631A	1.5K8.2A	7.02	7.79 - 8.61	10	12.1	200	124	.065	
1N5632	1.5K9.1	7.37	8.19 - 10.0	1	13.8	50	109	.068	
1N5632A	1.5K9.1A	7.78	8.65 - 9.55	1	13.4	50	112	.068	
1N5633	1.5K10	8.10	9.00 - 11.0	1	15.0	10	100	.073	
1N5633A	1.5K10A	8.55	9.5 - 10.5	1	14.5	10	103	.073	
1N5634	1.5K11	8.92	9.9 - 12.1	1	16.2	5	96	.075	
1N5634A	1.5K11A	9.40	10.5 - 11.6	1	15.6	5	96	.075	
1N5635	1.5K12	9.72	10.8 - 13.2	1	17.3	5	87	.078	
1N5635A	1.5K12A	10.2	11.4 - 12.6	1	16.7	5	90	.078	
1N5636	1.5K13	10.5	11.7 - 14.3	1	19.0	5	79	.081	
1N5636A	1.5K13A	11.1	12.4 - 13.7	1	18.2	5	82	.081	
1N5637	1.5K15	12.1	13.5 - 16.5	1	22.0	5	68	.084	
1N5637A	1.5K15A	12.8	14.3 - 15.8	1	21.2	5	71	.084	
1N5638	1.5K16	12.9	14.4 - 17.6	1	23.5	5	64	.086	
1N5638A	1.5K16A	13.6	15.2 - 16.8	1	22.5	5	67	.086	
1N5639	1.5K18	14.5	16.2 - 19.8	1	26.5	5	56.5	.088	
1N5639A	1.5K18A	15.3	17.1 - 18.9	1	25.2	5	59.5	.088	
1N5640	1.5K20	16.2	18.0 - 22.0	1	29.1	5	51.5	.090	
1N5640A	1.5K20A	17.1	19.0 - 21.0	1	27.7	5	54	.090	
1N5641	1.5K22	17.8	19.8 - 24.2	1	31.9	5	47	.092	
1N5641A	1.5K22A	18.8	20.9 - 23.1	1	30.6	5	49	.092	
1N5642	1.5K24	19.4	21.6 - 26.4	1	34.7	5	43	.094	
1N5642A	1.5K24A	20.5	22.8 - 25.2	1	33.2	5	45	.094	
1N5643	1.5K27	21.8	24.3 - 29.7	1	39.1	5	38.5	.096	
1N5643A	1.5K27A	23.1	25.7 - 28.4	1	37.5	5	40	.096	
1N5644	1.5K30	24.3	27.0 - 33.0	1	43.5	5	34.5	.097	
1N5644A	1.5K30A	25.6	28.5 - 31.5	1	41.4	5	36	.097	
1N5645	1.5K33	26.8	29.7 - 36.3	1	47.7	5	31.5	.098	
1N5645A	1.5K33A	28.2	31.4 - 34.7	1	45.7	5	33	.098	
1N5646	1.5K36	29.1	32.4 - 39.6	1	52.0	5	29	.099	
1N5646A	1.5K36A	30.8	34.2 - 37.8	1	49.9	5	30	.099	
1N5647	1.5K39	31.6	35.1 - 42.9	1	56.4	5	26.5	.100	
1N5647A	1.5K39A	33.3	37.1 - 41.0	1	53.9	5	28	.100	
1N5648	1.5K43	34.8	38.7 - 47.3	1	61.9	5	24	.101	
1N5648A	1.5K43A	36.8	40.9 - 45.2	1	59.3	5	25.3	.101	
1N5649	1.5K47	38.1	42.3 - 51.7	1	67.8	5	22.2	.101	
1N5649A	1.5K47A	40.2	44.7 - 49.4	1	64.8	5	23.2	.101	
1N5650	1.5K51	41.3	45.9 - 56.1	1	73.5	5	20.4	.102	
1N5650A	1.5K51A	43.6	48.5 - 53.6	1	70.1	5	21.4	.102	
1N5651	1.5K56	45.4	50.4 - 61.6	1	80.5	5	18.6	.103	
1N5651A	1.5K56A	47.8	53.2 - 58.8	1	77.0	5	19.5	.103	
1N5652	1.5K62	50.2	55.8 - 68.2	1	89.0	5	16.9	.104	
1N5652A	1.5K62A	53.0	58.9 - 65.1	1	85.0	5	17.7	.104	
1N5653	1.5K68	55.1	61.2 - 74.8	1	98.0	5	15.3	.104	
1N5653A	1.5K68A	58.1	64.6 - 71.4	1	92.0	5	16.3	.104	
1N5654	1.5K75	60.7	67.5 - 82.5	1	108.0	5	13.9	.105	
1N5654A	1.5K75A	64.1	71.3 - 78.8	1	103.0	5	14.6	.105	
1N5655	1.5K82	66.4	73.8 - 90.2	1	118.0	5	12.7	.105	
1N5655A	1.5K82A	70.1	77.9 - 86.1	1	113.0	5	13.3	.105	
1N5656	1.5K91	73.7	81.9 - 100.0	1	131.0	5	11.4	.106	
1N5656A	1.5K91A	77.8	86.5 - 95.5	1	125.0	5	12.0	.106	
1N5657	1.5K100	81.0	90.0 - 110.0	1	144.0	5	10.4	.106	
1N5657A	1.5K100A	85.5	95.0 - 105.0	1	137.0	5	11.0	.106	
1N5658	1.5K110	89.2	99.0 - 121.0	1	158.0	5	9.5	.107	
1N5658A	1.5K110A	94.0	105.0 - 116.0	1	152.0	5	9.9	.107	
1N5659	1.5K120	97.2	108.0 - 132.0	1	173.0	5	8.7	.107	
1N5659A	1.5K120A	102.0	114.0 - 126.0	1	165.0	5	9.1	.107	
1N5660	1.5K130	105.0	117.0 - 143.0	1	187.0	5	8.0	.107	
1N5660A	1.5K130A	111.0	124.0 - 137.0	1	179.0	5	8.4	.107	
1N5661	1.5K150	121.0	135.0 - 165.0	1	215.0	5	7.0	.108	
1N5661A	1.5K150A	128.0	143.0 - 158.0	1	207.0	5	7.2	.108	
1N5662	1.5K160	130.0	144.0 - 176.0	1	230.0	5	6.5	.108	
1N5662A	1.5K160A	136.0	152.0 - 168.0	1	219.0	5	6.8	.108	
1N5663	1.5K170	138.0	153.0 - 187.0	1	244.0	5	6.2	.108	
1N5663A	1.5K170A	145.0	162.0 - 179.0	1	234.0	5	6.4	.108	
1N5664	1.5K180	146.0	162.0 - 198.0	1	258.0	5	5.8	.108	
1N5664A	1.5K180A	154.0	171.0 - 189.0	1	246.0	5	6.1	.108	
1N5665	1.5K200	162.0	180.0 - 220.0	1	287.0	5	5.2	.108	
1N5665A	1.5K200A	171.0	190.0 - 210.0	1	274.0	5	5.5	.108	

V_f at 100 amps peak, 8.3 msec sine wave equals 3.5 volts maximum

JAN & JANTXV available per MIL-S-19500/500

Note 1: A TransZorb is normally selected according to the reverse "Stand Off Voltage" (V_R) which should be equal to or greater than the DC or continuous peak operating voltage level.



**GENERAL
SEMICONDUCTOR
INDUSTRIES, INC.**

TRANSZORB[®]
TRANSIENT VOLTAGE
SUPPRESSORS
1N5907
1N5908

1
TRANSZORBS

DESCRIPTION

... Silicon Transient Suppressors introduced and registered by General Semiconductor for the protection of 5.0 volt logic circuits. The 1N5907 and 1N5908 protect TTL, ECL, DTL, MOS and MSI integrated circuits requiring 5.0 volt or lower power supplies. These devices are rated for a peak pulse power of 1500 watts for 1 millisecond.

The 1N5907 TransZorb, packaged in a hermetically sealed glass-to-metal package, is available in JAN, JANTX & JANTXV qualified to MIL-STD 19500/500.

- Designed for protection of T²L Logic
- 5.0 Volt reverse standoff

MAXIMUM RATINGS

- 1500 Watts of Peak Pulse Power dissipation at 25°C
- t_{clamping} (0 volts to BV min): Less than 1 x 10⁻¹² seconds
- Operating and Storage Temperatures: -65° to +175°C
- Forward surge rating: 200 amps, 1/120 second at 25°C
- Steady State power dissipation: 1N5907 - 1.0 watt
1N5908 - 5.0 W @ T_L = 75°C, Lead Length = 3/8"
- Repetition rate (duty cycle) : 1N5907 - .01%
1N5908 - .05%

MECHANICAL CHARACTERISTICS

- 1N5907 - Standard DO-13 package, glass and hermetically sealed
- 1N5908 - Molded Case
- Weight: 1.5 grams (approximate)
- Positive terminal marked with band
- Body marked with Logo ✱ and type number

CAPACITANCE

- 15,000 pF at 0 Volts (typical)

ELECTRICAL CHARACTERISTICS

- Clamping Factor: 1.33 @ Full rated power
1.20 @ 50% rated power

Clamping Factor: The ratio of the actual V_C (Clamping Voltage) to the actual BV (Breakdown Voltage) as measured on a specific device. (See Figure 2, Page 1-1 for Test Pulse Wave Shape.)

- Peak Pulse Power vs Pulse Time. Figure 1, Page 1-1
- Pulse Wave Form. Figure 2, Page 1-1
- Power-Temperature Derating Curve. Figure 3, Page 1-1
- Capacitor Discharge Test Circuit. Figure 4, Page 1-2

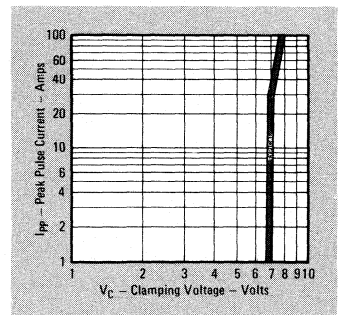
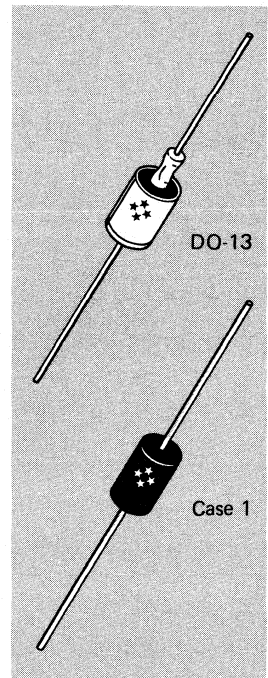

Typical Characteristic Clamping Voltage (V_C) vs Peak Pulse Current (I_{pp})

ELECTRICAL CHARACTERISTICS @ 25°C

JEDEC TYPE NUMBER	REVERSE STAND-OFF VOLTAGE (Note 1) V_R VOLTS	MAXIMUM REVERSE LEAKAGE @ V_R I_R μA	MINIMUM BREAKDOWN VOLTAGE @ 1 mA BV VOLTS	MAXIMUM CLAMPING VOLTAGE @ I_{PP1} V_C VOLTS	PEAK PULSE CURRENT (Fig. 2) I_{PP1} A	MAXIMUM CLAMPING VOLTAGE @ I_{PP2} V_C VOLTS	PEAK PULSE CURRENT (Fig. 2) I_{PP2} A	MAXIMUM CLAMPING VOLTAGE @ I_{PP3} V_C VOLTS	PEAK PULSE CURRENT (Fig. 2) I_{PP3} A
1N5907	5.0	300	6.0	7.6	30	8.0	60	8.5	120
1N5908	5.0	300	6.0	7.6	30	8.0	60	8.5	120

Available in JAN & JANTXV per MIL-S-19500/500

Note 1: A TransZorb is normally selected according to the reverse "Stand Off Voltage" (V_R) which should be equal to or greater than the DC or continuous peak operating voltage level.

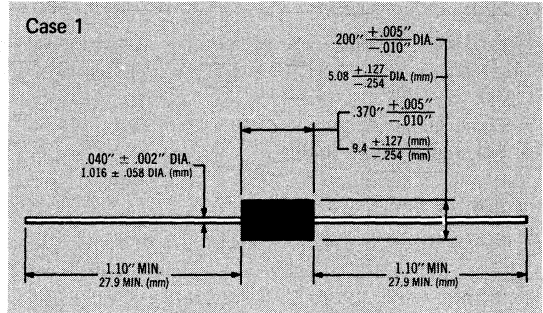
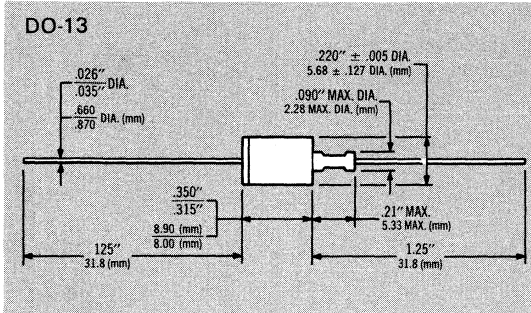

APPLICATION NOTES

The 1N5907 and 1N5908 TransZorbs are characterized by the reverse stand-off voltage (V_R). They are synonymous with the integrated circuit power supply voltage. The breakdown voltage (BV) is that point at which the TransZorb is in avalanche breakdown. This point is temperature dependent and

has a positive temperature coefficient. Allowance has been made in establishing the minimum breakdown voltage at 25°C to provide safe operation over the full military temperature range.

DC LINE APPLICATIONS

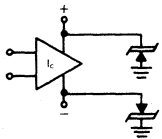

The TransZorb on the power line prevents IC failures caused by transients (electrostatic charge), power supply reversals or during switching of the power supply to on or off.

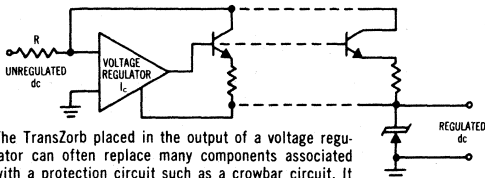

The TransZorb placed in the output of a voltage regulator can often replace many components associated with a protection circuit such as a crowbar circuit. It may also be required to protect the bypass transistor from voltage spikes across the collector to emitter terminals.

Typical power sources employing the TransZorb for Voltage Transient Protection.

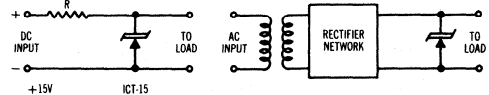

The TransZorb is chosen in which the reverse stand-off voltage is equal to or greater than the DC output voltage. For certain applications it may be more desirable to replace the series resistor (R) with an inductor. In most applications, a fuse in the line is desirable. Elimination of a transformer will require an LC filter on the line for most industrial applications, when the TransZorb is placed on the input to the power supply and with an input voltage greater than 40 volts.



**GENERAL
SEMICONDUCTOR
INDUSTRIES, INC.**

**BIDIRECTIONAL
TransZorb®
TRANSIENT VOLTAGE
SUPPRESSORS
1N6036
THRU
1N6072A**

1

TRANSZORB'S

DESCRIPTION

. . . a series of Bidirectional Silicon Transient Suppressors used in AC applications where large voltage transients can permanently damage voltage-sensitive components.

These devices are manufactured using two silicon PN, low voltage junction in a back to back configuration. They are characterized by their high surge capability, extremely fast response time, and low impedance, (R_{on}).

The TransZorb has a peak pulse power rating of 1500 watts for one millisecond and therefore can be used in applications where induced lightning on rural or remote transmission lines presents a hazard to electronic circuitry (ref: R.E.A. specification P.E. 60). The response time of TransZorb clamping action is less than (5×10^{-9}) sec; therefore, they can protect integrated Circuits, MOS devices, Hybrids, and other voltage-sensitive semiconductors and components.

This series of devices has been proven very effective as EMP Suppressors. Also available as JAN, JANTX, JANTXV devices per MIL-S-19500/507.

- 1500 watts peak power dissipation
- Available in standoff voltages from 5.5V to 185V
- DO-13 hermetically sealed package
- MIL qualified per MIL-S-19500/507
- **BIDIRECTIONAL**
- **UL Recognized (UL IN6070A)**

MAXIMUM RATINGS

- 1500 Watts of Peak Pulse Power dissipation at 25°C
- $t_{clamping}$ (0 volts to BV min): Less than 5×10^{-9} seconds
- Operating and Storage Temperatures: -65° to +175°C
- Steady State power dissipation: 1.0 watt
- Repetition rate (duty cycle): .01%

MECHANICAL CHARACTERISTICS

- Standard DO-13 package, glass and metal hermetically sealed
- Weight: 1.5 grams (approximate)
- Body marked with Logo and type number

ELECTRICAL CHARACTERISTICS

- Clamping Factor: 1.33 @ Full rated power
1.20 @ 50% rated power

Clamping Factor: The ratio of the actual V_C (Clamping Voltage) to the actual BV (Breakdown Voltage) as measured on a specific device. (See Figure 2, Page 1-1 for Test Pulse Wave Shape.)

- Peak Pulse Power vs Pulse Time. Figure 1, Page 1-1
- Pulse Wave Form. Figure 2, Page 1-1
- Power-Temperature Derating Curve. Figure 3, Page 1-1
- Capacitor Discharge Test Circuit. Figure 4, Page 1-2

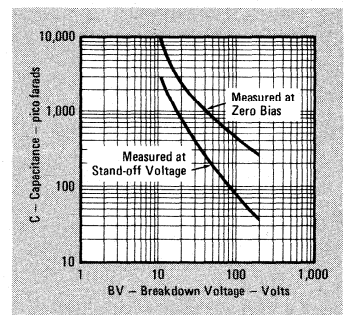
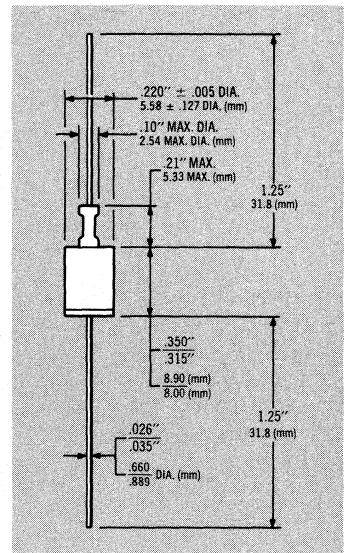
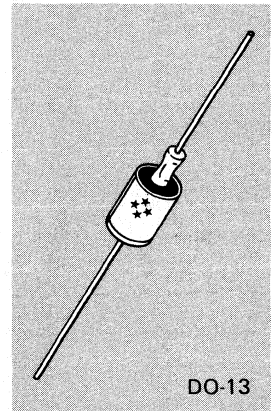

Typical Capacitance vs Breakdown Voltage

ELECTRICAL CHARACTERISTICS @ 25°C (Test Both Polarities)

JEDEC TYPE NUMBER	REVERSE STAND-OFF VOLTAGE (Note 1) V_R VOLTS	BREAKDOWN VOLTAGE @ I_T		I_T mA	MAXIMUM CLAMPING VOLTAGE @ I_{PP} (1 mSEC) V_C VOLTS	MAXIMUM REVERSE LEAKAGE @ V_R I_R μA	MAXIMUM PEAK PULSE CURRENT (Fig. 2) I_{PP} A	MAXIMUM TEMPERATURE COEFFICIENT OF BV %/°C
		BV VOLTS	@ VOLTS					
1N6036	5.5	6.75 - 8.25		10	11.7	1000	128	.061
1N6036A	6.0	7.13 - 7.88		10	11.3	1000	132	.061
1N6037	6.5	7.38 - 9.02		10	12.5	500	120	.065
1N6037A	7.0	7.79 - 8.61		10	12.1	500	124	.065
1N6038	7.0	8.19 - 10.0		10	13.8	200	109	.068
1N6038A	7.5	8.65 - 9.55		10	13.4	200	112	.068
1N6039	8.0	9.00 - 11.0		1	15.0	50	100	.073
1N6039A	8.5	9.5 - 10.5		1	14.5	50	103	.073
1N6040	8.5	9.9 - 12.1		1	16.2	10	93	.075
1N6040A	9.0	10.5 - 11.6		1	15.6	10	96	.075
1N6041	9.0	10.8 - 13.2		1	17.3	5	87	.078
1N6041A	10.0	11.4 - 12.6		1	16.7	5	90	.078
1N6042	10.0	11.7 - 14.3		1	19.0	5	79	.081
1N6042A	11.0	12.4 - 13.7		1	18.2	5	82	.081
1N6043	11.0	13.5 - 16.5		1	22.0	5	68	.084
1N6043A	12.0	14.3 - 15.8		1	21.2	5	71	.084
1N6044	12.0	14.4 - 17.6		1	23.5	5	64	.086
1N6044A	13.0	15.2 - 16.8		1	22.5	5	67	.086
1N6045	14.0	16.2 - 19.8		1	26.5	5	56.5	.088
1N6045A	15.0	17.1 - 18.9		1	25.2	5	59.5	.088
1N6046	16.0	18.0 - 22.0		1	29.1	5	51.5	.090
1N6046A	17.0	19.0 - 21.0		1	27.7	5	54	.090
1N6047	17.0	19.8 - 24.2		1	31.9	5	47	.092
1N6047A	18.0	20.9 - 23.1		1	30.6	5	49	.092
1N6048	19.0	21.6 - 26.4		1	34.7	5	43	.094
1N6048A	20.0	22.8 - 25.2		1	33.2	5	45	.094
1N6049	21.0	24.3 - 29.7		1	39.1	5	38.5	.096
1N6049A	22.0	25.7 - 28.4		1	37.5	5	40	.096
1N6050	24.0	27.0 - 33.0		1	43.5	5	34.5	.097
1N6050A	25.0	28.5 - 31.5		1	41.4	5	36	.097
1N6051	26.0	29.7 - 36.3		1	47.7	5	31.5	.098
1N6051A	28.0	31.4 - 34.7		1	45.7	5	33	.098
1N6052	29.0	32.4 - 39.6		1	52.0	5	29	.099
1N6052A	30.0	34.2 - 37.8		1	49.9	5	30	.099
1N6053	31.0	35.1 - 42.9		1	56.4	5	26.5	.100
1N6053A	33.0	37.1 - 41.0		1	53.9	5	28	.100
1N6054	34.0	38.7 - 47.3		1	61.9	5	24	.101
1N6054A	36.0	40.9 - 45.2		1	59.3	5	25.3	.101
1N6055	38.0	42.3 - 51.7		1	67.8	5	22.2	.101
1N6055A	40.0	44.7 - 49.4		1	64.8	5	23.2	.101
1N6056	41.0	45.9 - 56.1		1	73.5	5	20.4	.102
1N6056A	43.0	48.5 - 53.6		1	70.1	5	21.4	.102
1N6057	45.0	50.4 - 61.6		1	80.5	5	18.6	.103
1N6057A	47.0	53.2 - 58.8		1	77.0	5	19.5	.103
1N6058	48.0	55.8 - 68.2		1	89.0	5	16.9	.104
1N6058A	53.0	58.9 - 65.1		1	85.0	5	17.7	.104
1N6059	55.0	61.2 - 74.8		1	98.0	5	15.3	.104
1N6059A	58.0	64.6 - 71.4		1	92.0	5	16.3	.104
1N6060	60.0	67.5 - 82.5		1	108.0	5	13.9	.105
1N6060A	64.0	71.3 - 78.8		1	103.0	5	14.6	.105
1N6061	66.0	73.8 - 90.2		1	118.0	5	12.7	.105
1N6061A	70.0	77.9 - 86.1		1	113.0	5	13.3	.105
1N6062	73.0	81.9 - 100.0		1	131.0	5	11.4	.106
1N6062A	75.0	86.5 - 95.5		1	125.0	5	12.0	.106
1N6063	81.0	90.0 - 110.0		1	144.0	5	10.4	.106
1N6063A	82.0	95.0 - 105.0		1	137.0	5	11.0	.106
1N6064	90.0	99.0 - 121.0		1	158.0	5	9.5	.107
1N6064A	94.0	105.0 - 116.0		1	152.0	5	9.9	.107
1N6065	95.0	108.0 - 132.0		1	176.0	5	8.5	.107
1N6065A	100.0	114.0 - 126.0		1	168.0	5	8.9	.107
1N6066	105.0	117.0 - 143.0		1	191.0	5	7.8	.107
1N6066A	110.0	124.0 - 137.0		1	182.0	5	8.2	.107
1N6067	121.0	135.0 - 165.0		1	223.0	5	6.7	.108
1N6067A	128.0	143.0 - 158.0		1	213.0	5	7.0	.108
1N6068	137.0	153.0 - 187.0		1	258.0	5	5.8	.108
1N6068A	145.0	162.0 - 179.0		1	245.0	5	6.1	.108
1N6069	145.0	162.0 - 198.0		1	274.0	5	5.5	.108
1N6069A	150.0	171.0 - 189.0		1	261.0	5	5.7	.108
1N6070	155.0	171.0 - 210.0		1	292.0	5	5.1	.108
1N6070A	160.0	181.0 - 200.0		1	278.0	5	5.4	.108
1N6071	165.0	180.0 - 220.0		1	308.0	5	4.9	.108
1N6071A	170.0	190.0 - 210.0		1	294.0	5	5.1	.108
1N6072	175.0	198.0 - 242.0		1	344.0	5	4.3	.108
1N6072A	185.0	209.0 - 231.0		1	328.0	5	4.6	.108

Available in JAN, JANTX & JANTXV per MIL-S-19500/507

Note 1: A TransZorb is normally selected according to the reverse "Stand Off Voltage" (V_R) which should be equal to or greater than the DC or continuous peak operating voltage level.



**GENERAL
SEMICONDUCTOR
INDUSTRIES, INC.**

TRANSZORB®
**TRANSIENT VOLTAGE
SUPPRESSORS**
**1N6267
THRU
1N6303A**

1

TRANSZORB

DESCRIPTION

This specification sheet defines a series of Silicon Transient Suppressors used in applications where large voltage transients can permanently damage voltage-sensitive components.

TransZorbs are characterized by their high surge capability, extremely fast response time, and low impedance, (R_{ON}). Because of the unpredictable nature of transients and the variation of the impedance with respect to these transients, impedance per se is not specified as a parametric value. However, a minimum voltage at low current conditions (BV) and a maximum clamping voltage (V_C) at a maximum peak pulse current is specified. In addition, a maximum clamping ratio is indicated. In some instances the thermal effect (see V_C Clamping Voltage) may be responsible for 50% to 70% of the observed voltage differential when subjected to high-current pulses or severe duty cycles thus making a maximum impedance specification insignificant. Curves depicting clamping voltage vs. various current pulses are available from the factory. Extended power curves vs. pulse time are also available.

The TransZorb has a peak pulse power rating of 1500 watts for one millisecond and therefore can be used in applications where induced lightning on rural or remote transmission lines presents a hazard to electronic circuitry (ref: R.E.A. specification P.E. 60). The response time of TransZorb clamping action is theoretically instantaneous (1×10^{-12} sec); therefore, they can protect integrated Circuits, MOS device, Hybrids, and other voltage-sensitive semiconductors and components. TransZorbs can also be used in series or parallel to increase the peak power ratings.

This series of devices been proven very effective as EMP Suppressors. For the actual test results and application send for report number AD909267L, at the Defense Documentation Center, Alexandria, Virginia 22314. This specification sheet is only one of many series of Transient Voltage Suppressors available from General Semiconductor Industries.

In case of a severe current overload or abnormal transient beyond the maximum ratings, the TransZorb will initially fail "short" thus tripping the systems' circuit breaker or fuse while protecting the entire circuit. However, if current is sustained in the shorted mode, the device may exhibit an open condition. If the shorted mode is a desirable designed characteristic, we recommend the 1N5629 series of TransZorbs.

- 1500 watts peak power dissipation
- Available in ranges from 6.8V to 200V.
- UL Recognized (1.5KE200CA)

MAXIMUM RATINGS

- 1500 Watts of Peak Pulse Power dissipation at 25°C*
- $t_{clamping}$ (0 volts to BV min): Less than 1×10^{-12} seconds (theoretical)
- Operating and Storage Temperature: -65° to +175°C*
- Forward surge rating: 200 amps, 1/20 second at 25°C*
- Steady State power dissipation: 5.0 W @ $T_L = 75^\circ C$,*
Lead Length = 3/8"
- Bipolar Devices – Applies to GSI part numbers only

*Indicates JEDEC Registered Data

MECHANICAL CHARACTERISTICS

- Molded Case
- Weight: 1.5 grams (approximate)
- Positive terminal marked with band
- Body marked with Logo  and type number

ELECTRICAL CHARACTERISTICS

- Clamping Factor: 1.33 @ Full rated power
1.20 @ 50% rated power

Clamping Factor: The ratio of the actual V_C (Clamping Voltage) to the actual BV (Breakdown Voltage) as measured on a specific device. (See Figure 3 for test pulse wave shape.)

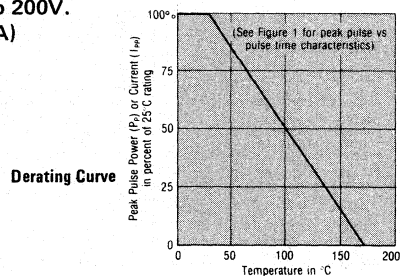
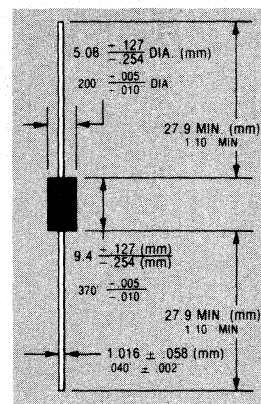
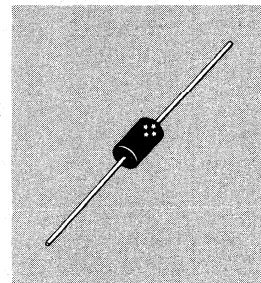

**FIGURE 1 –
Peak Pulse Power
vs Pulse Time**

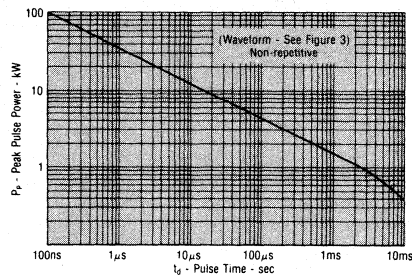

GENERAL SEMICONDUCTOR INDUSTRIES, INC.

ELECTRICAL CHARACTERISTICS at 25°C JEDEC Registered Data

JEDEC TYPE NUMBER	GSI PART NUMBER	REVERSE STAND-OFF VOLTAGE (Note 1) V _R VOLTS	BREAKDOWN VOLTAGE BV VOLTS		I _T mA	** MAXIMUM REVERSE LEAKAGE @ V _R I _R μA	MAXIMUM PEAK PULSE CURRENT (Notes 2) I _{PP} A	MAX. TEMP. COEFF. OF BV %/°C
			Min.	Max.				
1N6267	1.5KE6.8	5.50	6.12	7.48	10	10.8	139.0	.087
1N6267A	1.5KE6.8A	5.50	6.45	7.14	10	10.5	1000	.057
1N6268	1.5KE7.5	6.05	6.75	8.25	10	11.7	500	.081
1N6268A	1.5KE7.5A	6.40	7.13	7.88	10	11.3	500	.057
1N6269	1.5KE8.2	6.63	7.38	9.02	10	12.5	200	.065
1N6269A	1.5KE8.2A	7.02	7.79	8.61	10	12.1	200	.065
1N6270	1.5KE8.1	7.27	8.19	10.00	11	13.8	50	.068
1N6270A	1.5KE8.1A	7.28	8.65	9.55	11	13.4	50	.085
1N6271	1.5KE10	8.10	9.00	11.00	11	15.0	10	.073
1N6271A	1.5KE10A	8.55	9.50	10.50	11	14.5	10	.073
1N6272	1.5KE11	8.92	9.90	12.10	11	16.2	5	.075
1N6272A	1.5KE11A	9.40	10.50	11.60	11	15.6	5	.076
1N6273	1.5KE12	9.72	10.80	13.20	11	17.3	5	.078
1N6273A	1.5KE12A	10.20	11.40	12.60	11	16.7	5	.078
1N6274	1.5KE13	10.80	11.70	14.30	11	19.0	5	.081
1N6274A	1.5KE13A	11.10	12.40	13.70	11	18.2	5	.081
1N6275	1.5KE15	12.10	13.50	16.50	11	22.0	5	.084
1N6275A	1.5KE15A	12.80	14.30	15.80	11	21.2	5	.084
1N6276	1.5KE18	12.90	14.40	17.60	11	23.5	5	.086
1N6276A	1.5KE18A	13.60	15.20	16.90	11	22.5	5	.086
1N6277	1.5KE18	14.50	16.20	19.80	11	25.5	5	.088
1N6277A	1.5KE18A	15.30	17.10	18.90	11	25.2	5	.088
1N6278	1.5KE20	16.20	18.00	22.00	11	29.1	5	.090
1N6278A	1.5KE20A	17.10	19.00	21.00	11	27.7	5	.090
1N6279	1.5KE22	17.80	19.80	24.20	11	31.9	5	.092
1N6279A	1.5KE22A	18.30	20.90	23.10	11	30.6	5	.092
1N6280	1.5KE24	19.40	21.60	26.50	11	34.7	5	.094
1N6280A	1.5KE24A	20.50	22.80	25.20	11	33.2	5	.094
1N6281	1.5KE27	21.80	24.30	29.70	11	39.1	5	.096
1N6281A	1.5KE27A	23.10	26.70	28.40	11	37.5	5	.096
1N6282	1.5KE30	24.30	27.00	33.00	11	43.5	5	.097
1N6282A	1.5KE30A	25.60	28.60	31.50	11	41.4	5	.097
1N6283	1.5KE33	26.30	29.70	36.30	11	47.7	5	.098
1N6283A	1.5KE33A	28.20	31.40	34.70	11	45.7	5	.098
1N6284	1.5KE36	29.10	32.40	39.60	11	52.0	5	.099
1N6284A	1.5KE36A	30.80	34.20	37.80	11	49.9	5	.099
1N6285	1.5KE39	31.60	35.10	42.90	11	56.4	5	.100
1N6285A	1.5KE39A	33.30	37.10	41.00	11	53.9	5	.100
1N6286	1.5KE43	34.80	38.70	47.30	11	61.9	5	.101
1N6286A	1.5KE43A	36.80	40.90	45.20	11	59.3	5	.101
1N6287	1.5KE47	38.10	42.30	51.70	11	67.8	5	.101
1N6287A	1.5KE47A	40.20	44.70	49.40	11	64.8	5	.101
1N6288	1.5KE51	41.30	45.90	58.10	11	73.5	5	.102
1N6288A	1.5KE51A	43.60	48.50	53.60	11	70.1	5	.102
1N6289	1.5KE56	45.40	50.40	61.60	11	80.5	5	.103
1N6289A	1.5KE56A	47.80	53.20	58.80	11	77.0	5	.103
1N6290	1.5KE62	50.20	55.80	68.20	11	89.0	5	.104
1N6290A	1.5KE62A	53.00	58.90	65.10	11	85.0	5	.104
1N6291	1.5KE68	55.10	61.20	74.80	11	98.0	5	.104
1N6291A	1.5KE68A	58.00	64.50	71.40	11	92.0	5	.104
1N6292	1.5KE75	60.70	67.50	82.50	11	108.0	5	.105
1N6292A	1.5KE75A	64.10	71.30	78.80	11	103.0	5	.105
1N6293	1.5KE82	66.40	73.80	90.20	11	118.0	5	.105
1N6293A	1.5KE82A	70.10	77.90	86.10	11	113.0	5	.105
1N6294	1.5KE91	73.70	81.90	100.00	11	131.0	5	.106
1N6294A	1.5KE91A	77.80	86.60	95.60	11	125.0	5	.106
1N6295	1.5KE100	81.00	90.00	110.00	11	144.0	5	.106
1N6295A	1.5KE100A	85.50	95.00	105.00	11	137.0	5	.106
1N6296	1.5KE110	89.20	99.00	121.00	11	158.0	5	.107
1N6296A	1.5KE110A	94.00	105.00	116.00	11	152.0	5	.107
1N6297	1.5KE120	97.20	108.00	132.00	11	173.0	5	.107
1N6297A	1.5KE120A	102.00	114.00	128.00	11	168.0	5	.107
1N6298	1.5KE130	105.00	117.00	143.00	11	187.0	5	.107
1N6298A	1.5KE130A	111.00	124.00	137.00	11	179.0	5	.107
1N6299	1.5KE150	121.00	135.00	165.00	11	215.0	5	.108
1N6299A	1.5KE150A	128.00	143.00	158.00	11	207.0	5	.108
1N6300	1.5KE180	130.00	144.00	176.00	11	230.0	5	.108
1N6300A	1.5KE180A	136.00	152.00	168.00	11	219.0	5	.108
1N6301	1.5KE170	138.00	153.00	187.00	11	244.0	5	.108
1N6301A	1.5KE170A	145.00	162.00	179.00	11	234.0	5	.108
1N6302	1.5KE180	146.00	162.00	198.00	11	258.0	5	.108
1N6302A	1.5KE180A	154.00	171.00	189.00	11	248.0	5	.108
1N6303	1.5KE200	162.00	180.00	220.00	11	287.0	5	.108
1N6303A	1.5KE200A	169.00	190.00	210.00	11	274.0	5	.108
	1.5KE220	175.00	198.00	242.00	11	344.0	5	.108
	1.5KE220A	185.00	209.00	231.00	11	326.0	5	.108
	1.5KE250*	202.00	225.00	275.00	11	360.0	5	.110
	1.5KE250A*	214.00	237.00	263.00	11	344.0	5	.110
	1.5KE300*	243.00	270.00	330.00	11	430.0	5	.110
	1.5KE300A*	258.00	285.00	315.00	11	414.0	5	.110
	1.5KE350*	284.00	315.00	385.00	11	504.0	5	.110
	1.5KE350A*	300.00	333.00	369.00	11	482.0	5	.110
	1.5KE400*	324.00	360.00	440.00	11	574.0	5	.110
	1.5KE400A*	342.00	380.00	420.00	11	548.0	5	.110

*Vf at 100 AMPS PEAK, 8.3 MSEC SINE WAVE equals 3.5 VOLTS MAXIMUM

**For Bipolar types 1.5KE7.5C thru 1.5KE11CA, I_R max. must be doubled that shown for single polarity types.

BIPOLAR APPLICATIONS Electrical characteristics apply in both directions. For Bipolar use C or CA Suffix for types

1.5KE7.5 through type 1.5KE200.

Example: 1.5KE7.5C - 1.5KE200C
1.5KE7.5CA - 1.5KE200CA

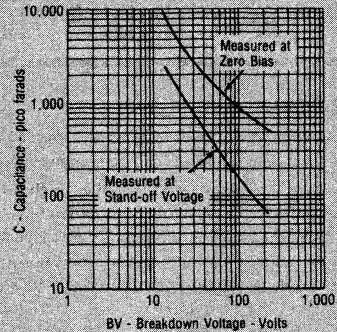

FIGURE 2
Typical Capacitance vs Breakdown Voltage

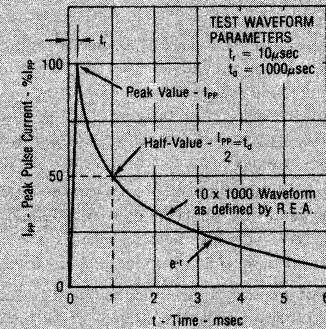
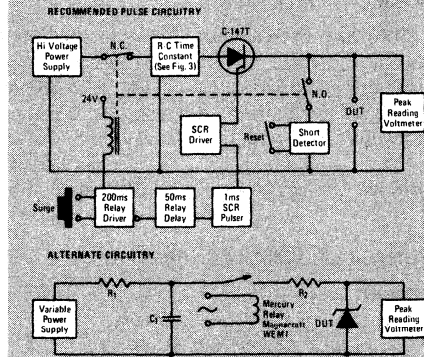

FIGURE 3 - Pulse Wave Form

Capacitor Discharge Circuit for Testing Transzorb



RC TIME CONSTANTS
R₁ - 3 or 20 ohms, 10 watts
C₁ - 400F, 600V, 40.F., 600V

Note 2: The most significant electrical characteristic of transient suppressors is the surge handling capability. All Transzorb are subjected 100% to the Maximum Peak Pulse Current (I_{PP}) as indicated in the electrical characteristic table and the clamping voltage is monitored. This test should be part of the customer's quality control incoming inspection procedure. Recommended commercial test equipment Keytek, Model 424 surge generator/monitor Keytek Inst. Co.



**GENERAL
SEMICONDUCTOR
INDUSTRIES, INC.**

TRANSZORB[®]
TRANSIENT VOLTAGE
SUPPRESSORS
1.5KC6.8
THRU
1.5KC110A

1
TRANSZORB8

DESCRIPTION

. . . a leadless TransZorb designed for direct retro-fit or replacement of a gas-discharge suppressor when lower voltages are needed to protect voltage sensitive circuitry.

TransZorbs have proven to be effective in Airborne Avionics and Controls, Mobile Communication Equipment, Computer Power Supplies, Numerically Controlled Machinery, and in many other applications where inductive and switching transients are present.

- 1500 watts peak power dissipation
- Available in ranges from 6.8V to 110V
- Leadless TransZorb

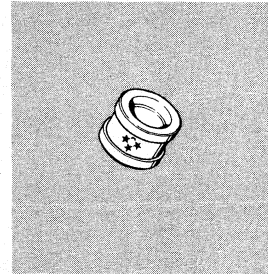

MAXIMUM RATINGS

- 1500 Watts of Peak Pulse Power dissipation at 25°C
- $t_{clamping}$ (0 volts to BV min): Less than 1×10^{-12} seconds
- Operating and Storage Temperatures: -65° to +175°C
- Forward surge rating: 200 amps, 1/120 second at 25°C
- Steady State power dissipation: 1.0 watt
- Repetition rate (duty cycle): .01%

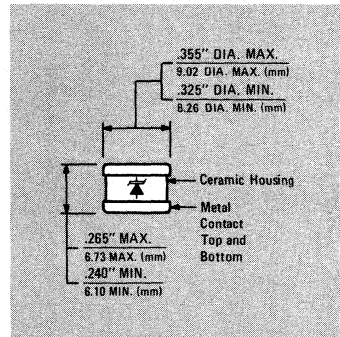

MECHANICAL CHARACTERISTICS

- Ceramic Case with Metal Caps
- Weight: 1.25 grams (approximate)
- Polarity marked with polarity symbol
- Body marked with Logo * and type number

ELECTRICAL CHARACTERISTICS

- Clamping Factor: 1.33 @ Full rated power
1.15 @ 50% rated power

Clamping Factor: The ratio of the actual V_C (Clamping Voltage) to the actual BV (Breakdown Voltage) as measured on a specific device. (See Figure 2, Page 1-1 for Test Pulse Wave Shape.)

DEVICES FOR BIPOLAR APPLICATIONS

For Bidirectional types use C or CA Suffix for types 1.5KC7.5 through 1.5KC110. Electrical characteristics apply in both polarities. The maximum reverse leakage current must be doubled for types up through 11 volts for bipolar devices.

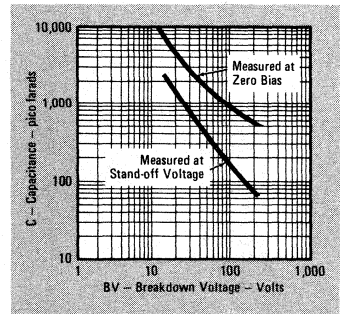

Typical Capacitance vs Breakdown Voltage

- Peak Pulse Power vs Pulse Time. Figure 1, Page 1-1
- Pulse Wave Form. Figure 2, Page 1-1
- Power-Temperature Derating Curve. Figure 3, Page 1-1
- Capacitor Discharge Test Circuit. Figure 4, Page 1-2

ELECTRICAL CHARACTERISTICS @ 25°C

GENERAL SEMICONDUCTOR PART NUMBER	REVERSE STAND-OFF VOLTAGE (Note 1)	BREAKDOWN VOLTAGE		I _T mA	MAXIMUM CLAMPING VOLTAGE @ I _{SP} (1 mSEC) V _C	MAXIMUM REVERSE LEAKAGE @ V _R I _R †	MAXIMUM PEAK PULSE CURRENT (Fig. 2) I _{PP}	MAXIMUM TEMPERATURE COEFFICIENT OF V _F
	V _R VOLTS	BV	@ VOLTS		VOLTS	μA	A	%/°C
* 1.5KC6.8	5.50	6.12 - 7.48		10	10.8	1000	139	.057
* 1.5KC6.8A	5.80	6.45 - 7.14		10	10.5	1000	143	.057
1.5KC7.5	6.05	6.75 - 8.25		10	11.7	500	128	.061
1.5KC7.5A	6.40	7.13 - 7.88		10	11.3	500	132	.061
1.5KC8.2	6.63	7.38 - 9.02		10	12.5	200	120	.065
1.5KC8.2A	7.02	7.79 - 8.61		10	12.1	200	124	.065
1.5KC9.1	7.37	8.19 - 10.0		1	13.8	50	109	.068
1.5KC9.1A	7.78	8.65 - 9.55		1	13.4	50	112	.068
1.5KC10	8.10	9.00 - 11.0		1	15.0	10	100	.073
1.5KC10A	8.55	9.5 - 10.5		1	14.5	10†	103	.073
1.5KC11	8.92	9.9 - 12.1		1	16.2	5	93	.075
1.5KC11A	9.40	10.5 - 11.6		1	15.6	5	96	.075
1.5KC12	9.72	10.8 - 13.2		1	17.3	5	87	.078
1.5KC12A	10.2	11.4 - 12.6		1	16.7	5	90	.078
1.5KC13	10.5	11.7 - 14.3		1	19.0	5	79	.081
1.5KC13A	11.1	12.4 - 13.7		1	18.2	5	82	.081
1.5KC15	12.1	13.5 - 16.5		1	22.0	5	68	.084
1.5KC15A	12.8	14.3 - 15.8		1	21.2	5	71	.084
1.5KC16	12.9	14.4 - 17.6		1	23.5	5	64	.086
1.5KC16A	13.6	15.2 - 16.8		1	22.5	5	67	.086
1.5KC18	14.5	16.2 - 19.8		1	26.5	5	56.5	.088
1.5KC18A	15.3	17.1 - 18.9		1	25.2	5	59.5	.088
1.5KC20	16.2	18.0 - 22.0		1	29.1	5	51.5	.090
1.5KC20A	17.1	19.0 - 21.0		1	27.7	5	54	.090
1.5KC22	17.8	19.8 - 24.2		1	31.9	5	47	.092
1.5KC22A	18.8	20.9 - 23.1		1	30.6	5	49	.092
1.5KC24	19.4	21.6 - 26.4		1	34.7	5	43	.094
1.5KC24A	20.5	22.8 - 25.2		1	33.2	5	45	.094
1.5KC27	21.8	24.3 - 29.7		1	39.1	5	38.5	.096
1.5KC27A	23.1	25.7 - 28.4		1	37.5	5	40	.096
1.5KC30	24.3	27.0 - 33.0		1	43.5	5	34.5	.097
1.5KC30A	25.6	28.5 - 31.5		1	41.4	5	36	.097
1.5KC33	26.8	29.7 - 36.3		1	47.7	5	31.5	.098
1.5KC33A	28.2	31.4 - 34.7		1	45.7	5	33	.098
1.5KC36	29.1	32.4 - 39.6		1	52.0	5	29	.099
1.5KC36A	30.8	34.2 - 37.8		1	49.9	5	30	.099
1.5KC39	31.6	35.1 - 42.9		1	56.4	5	26.5	.100
1.5KC39A	33.3	37.1 - 41.0		1	53.9	5	28	.100
1.5KC43	34.8	38.7 - 47.3		1	61.9	5	24	.101
1.5KC43A	36.8	40.9 - 45.2		1	59.3	5	25.3	.101
1.5KC47	38.1	42.3 - 51.7		1	67.8	5	22.2	.101
1.5KC47A	40.2	44.7 - 49.4		1	64.8	5	23.2	.101
1.5KC51	41.3	45.9 - 56.1		1	73.5	5	20.4	.102
1.5KC51A	43.6	48.5 - 53.6		1	70.1	5	21.4	.102
1.5KC56	45.4	50.4 - 61.6		1	80.5	5	18.6	.103
1.5KC56A	47.8	53.2 - 58.8		1	77.0	5	19.5	.103
1.5KC62	50.2	55.8 - 68.2		1	89.0	5	16.9	.104
1.5KC62A	53.0	58.9 - 65.1		1	85.0	5	17.7	.104
1.5KC68	55.1	61.2 - 74.8		1	98.0	5	15.3	.104
1.5KC68A	58.1	64.6 - 71.4		1	92.0	5	16.3	.104
1.5KC75	60.7	67.5 - 82.5		1	108.0	5	13.9	.105
1.5KC75A	64.1	71.3 - 78.8		1	103.0	5	14.6	.105
1.5KC82	66.4	73.8 - 90.2		1	118.0	5	12.7	.105
1.5KC82A	70.1	77.9 - 86.1		1	113.0	5	13.3	.105
1.5KC91	73.7	81.9 - 100.0		1	131.0	5	11.4	.106
1.5KC91A	77.8	86.5 - 95.5		1	125.0	5	12.0	.106
1.5KC100	81.0	90.0 - 110.0		1	144.0	5	10.4	.106
1.5KC100A	85.5	95.0 - 105.0		1	137.0	5	11.0	.106
1.5KC110	89.2	99.0 - 121.0		1	158.0	5	9.5	.107
1.5KC110A	94.0	105.0 - 116.0		1	152.0	5	9.9	.107

V_F at 100 amps peak, 8.3 msec sine wave equals 3.5 volts maximum *Not available as Bidirectional

Note 1: A TransZorb is normally selected according to the reverse "Stand Off Voltage" (V_R) which should be equal to or greater than the DC or continuous peak operating voltage level.

† For bipolar types 1.5KC7.5CA thru 1.5KC11CA, I_R MAX must be double that specified for single polarity types.



**GENERAL
SEMICONDUCTOR
INDUSTRIES, INC.**

TRANSZORB[®]
**TRANSIENT VOLTAGE
 SUPPRESSORS**
5KP5.0
 THRU
5KP110A

1
TRANSZORB

DESCRIPTION

... a series of high power transient voltage suppressors designed to be used on the output of switching power supplies. These devices may be used to replace crowbar circuits. Both the 5 and 10 percent voltage tolerances are referenced to the power supply output voltage level.

TransZorbs are Silicon PN Junction devices designed for absorption of high voltage transients associated with power disturbances, switching and induced lightning effects. This series is available from 5.0 volts thru 110 volts.

- **Designed for DC power supply applications**
- **Available in ranges from 5.0 to 110 volts**

MAXIMUM RATINGS

- 5,000 watts of Peak Pulse Power dissipation at 25°C
- $t_{clamping}$ (0 volts to BV min): Less than 1×10^{-12} seconds
- Operating and Storage temperature: -55° to +150°C
- Steady State power dissipation: 5.0 watts @ $T_L = 25^\circ C$
- Repetition rate (duty cycle): .05%

MECHANICAL CHARACTERISTICS

- Molded (Plastic) Case
- Weight: 4 grams (approximate)
- Positive terminal marked with band
- Body marked with Logo and type number

Pulse Wave Form Figure 2, Page 1-1
 Power-Temperature Derating Curve Figure 3, Page 1-1
 Capacitor Discharge Test Circuit Figure 4, Page 1-2

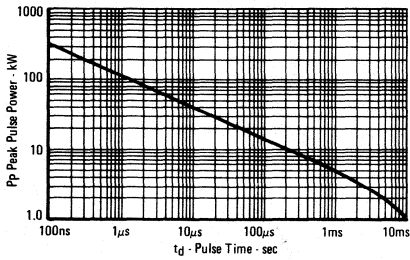
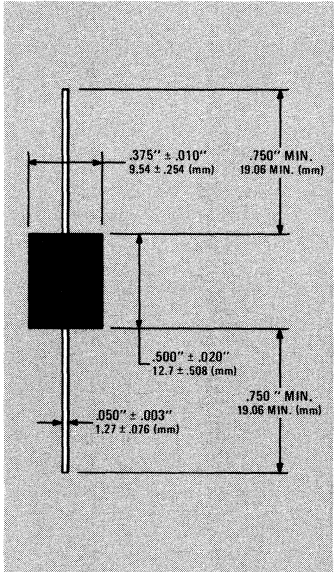
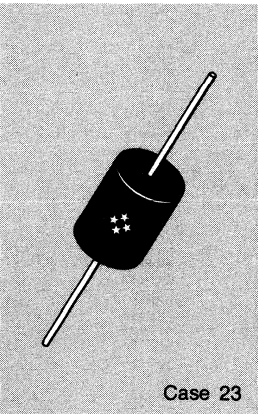

Figure 1 - Peak Power vs Pulse Time

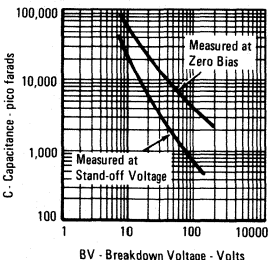

Figure 2 - Typical Capacitance vs Breakdown Voltage

ELECTRICAL CHARACTERISTICS @ 25°C

GENERAL SEMICONDUCTOR PART NUMBER	REVERSE STAND-OFF VOLTAGE (Note 1)	BREAKDOWN VOLTAGE		MAXIMUM CLAMPING VOLTAGE @ I _{PP} (1 mSEC) V _C	MAXIMUM REVERSE LEAKAGE @ V _R I _R	MAXIMUM PEAK PULSE CURRENT (Fig. 3) I _{PP}	MAXIMUM VOLTAGE TEMPERATURE VARIATION OF BV
	V _R VOLTS	BV @ VOLTS	I _T mA				
5KP5.0	5.0	6.40 - 7.30	50	9.6	2000	520	4.0
5KP5.0A	5.0	6.40 - 7.00	50	9.2	2000	543	4.0
5KP6.0	6.0	6.67 - 8.15	50	11.4	5000	439	4.0
5KP6.0A	6.0	6.67 - 7.37	50	10.3	5000	485	4.0
5KP6.5	6.5	7.22 - 8.82	50	12.3	2000	407	4.0
5KP6.5A	6.5	7.22 - 7.98	50	11.2	2000	447	4.0
5KP7.0	7.0	7.78 - 9.51	50	13.3	1000	378	5.0
5KP7.0A	7.0	7.78 - 8.60	50	12.0	1000	417	5.0
5KP7.5	7.5	8.33 - 10.2	5	14.3	250	350	6.0
5KP7.5A	7.5	8.33 - 9.21	5	12.9	250	388	6.0
5KP8.0	8.0	8.89 - 10.9	5	15.0	150	333	6.0
5KP8.0A	8.0	8.89 - 9.83	5	13.6	150	367	6.0
5KP8.5	8.5	9.44 - 11.5	5	15.9	50	314	7.0
5KP8.5A	8.5	9.44 - 10.4	5	14.4	50	347	7.0
5KP9.0	9.0	10.0 - 12.2	5	16.9	20	295	8.0
5KP9.0A	9.0	10.0 - 11.1	5	15.4	20	325	8.0
5KP10	10	11.1 - 13.6	5	18.8	15	266	9.0
5KP10A	10	11.1 - 12.3	5	17.0	15	294	9.0
5KP11	11	12.2 - 14.9	5	20.1	10	249	10
5KP11A	11	12.2 - 13.5	5	18.2	10	274	10
5KP12	12	13.3 - 16.3	5	22.0	10	227	11
5KP12A	12	13.3 - 14.7	5	19.9	10	251	11
5KP13	13	14.4 - 17.6	5	23.8	10	210	12
5KP13A	13	14.4 - 15.9	5	21.5	10	232	12
5KP14	14	15.6 - 19.1	5	25.8	10	194	13
5KP14A	14	15.6 - 17.2	5	23.2	10	215	13
5KP15	15	16.7 - 20.4	5	26.9	10	188	15
5KP15A	15	16.7 - 18.5	5	24.4	10	206	15
5KP16	16	17.8 - 21.8	5	28.8	10	176	18
5KP16A	16	17.8 - 19.7	5	26.0	10	192	16
5KP17	17	18.9 - 23.1	5	30.5	10	164	19
5KP17A	17	18.9 - 20.9	5	27.6	10	181	18
5KP18	18	20.0 - 24.4	5	32.2	10	155	20
5KP18A	18	20.0 - 22.1	5	29.2	10	172	19
5KP20	20	22.2 - 27.1	5	35.8	10	139	24
5KP20A	20	22.2 - 24.5	5	32.4	10	154	22
5KP22	22	24.4 - 29.8	5	39.4	10	127	27
5KP22A	22	24.4 - 26.9	5	35.5	10	141	24
5KP24	24	26.7 - 32.6	5	43.0	10	116	30
5KP24A	24	26.7 - 29.5	5	38.9	10	128	27
5KP26	26	28.9 - 35.3	5	46.6	10	107	33
5KP26A	26	28.9 - 31.9	5	42.1	10	119	29
5KP28	28	31.1 - 38.0	5	50.1	10	99	34
5KP28A	28	31.1 - 34.4	5	45.4	10	110	30
5KP30	30	33.3 - 40.7	5	53.5	10	93	38
5KP30A	30	33.3 - 36.8	5	48.4	10	103	35
5KP33	33	36.7 - 44.9	5	59.0	10	85	41
5KP33A	33	36.7 - 40.6	5	53.3	10	94	38
5KP36	36	40.0 - 48.9	5	64.3	10	78	45
5KP36A	36	40.0 - 44.2	5	58.1	10	86	40
5KP40	40	44.4 - 54.3	5	71.4	10	70	50
5KP40A	40	44.4 - 49.1	5	64.5	10	78	45
5KP43	43	47.8 - 58.4	5	76.7	10	65	54
5KP43A	43	47.8 - 52.8	5	69.4	10	72	49
5KP45	45	50.0 - 61.1	5	80.3	10	62	57
5KP45A	45	50.0 - 55.3	5	72.7	10	69	51
5KP48	48	53.3 - 65.1	5	85.5	10	58	62
5KP48A	48	53.3 - 58.9	5	77.4	10	65	55
5KP51	51	56.7 - 69.3	5	91.1	10	55	65
5KP51A	51	56.7 - 62.7	5	82.4	10	61	60
5KP54	54	60.0 - 73.3	5	96.3	10	52	70
5KP54A	54	60.0 - 66.3	5	87.1	10	57	64
5KP58	58	64.4 - 78.7	5	103.0	10	49	77
5KP58A	58	64.4 - 71.2	5	93.6	10	53	69
5KP60	60	66.7 - 81.5	5	107.0	10	47	79
5KP60A	60	66.7 - 73.7	5	96.8	10	52	70
5KP64	64	71.1 - 86.9	5	114.0	10	44	85
5KP64A	64	71.1 - 78.6	5	103.0	10	49	75
5KP70	70	77.8 - 95.1	5	125	10	40	93
5KP70A	70	77.8 - 86.0	5	113	10	44	84
5KP75	75	83.3 - 102.0	5	134	10	37	100
5KP75A	75	83.3 - 92.1	5	121	10	41	90
5KP78	78	86.7 - 106.0	5	139	10	36	104
5KP78A	78	86.7 - 95.8	5	126	10	40	94
5KP85	85	94.4 - 115.0	5	151	10	33	113
5KP85A	85	94.4 - 104.0	5	137	10	36	102
5KP90	90	100 - 122	5	160	10	31	120
5KP90A	90	100 - 111	5	146	10	34	109
5KP100	100	111 - 136	5	179	10	28	134
5KP100A	100	111 - 123	5	162	10	31	122
5KP110	110	122 - 149	5	196	10	26	147
5KP110A	110	122 - 135	5	177	10	28	132

V_f at 100 amps peak, 8.3 msec sine wave equals 3.5 volts maximum

Note 1: A TransZorb is normally selected according to the reverse "Stand Off Voltage" (V_R) which should be equal to or greater than the DC or continuous peak operating voltage level.



**GENERAL
SEMICONDUCTOR
INDUSTRIES, INC.**

TRANSZORBSM
**TRANSIENT VOLTAGE
 SUPPRESSORS**
15KP17
 THRU
15KP280A

1
TRANSZORBSM

DESCRIPTION

... a series of high power, medium voltage TransZorbs, Transient Voltage Suppressors, designed for the protection of Precision Industrial Electronic Equipment. These devices are rated for a peak pulse power of 15,000 watts for 1 millisecond.

TransZorbs are Silicon PN Junction devices designed for absorption of high voltage transients associated with power disturbances, switching, and induced lightning effects. This series is available from 17 volts through 280 volts. Special voltages are available from the factory.

- **Designed for 15,000 watts**
- **Easy mounting to printed circuit board**
- **Available in ranges from 17 to 280 volts**

MAXIMUM RATINGS

- 15,000 watts of Peak Pulse Power dissipation at 25°C
- $t_{clamping}$ (0 volts to BV min): Less than 1×10^{-12}
- Operating and Storage temperature: -55°C to +150°C
- Steady State power dissipation: 7.0 watts @ $T_A = 25^\circ C$
- Repetition rate (duty cycle): .05%

MECHANICAL CHARACTERISTICS

- Molded (Plastic) Case
- Weight: 13 grams (approximate)
- Positive Terminal marked with dot
- Body marked with Logo and type number

Pulse Wave Form. Figure 2, Page 1-1
 Power-Temperature Derating Curve. Figure 3, Page 1-1
 Capacitor Discharge Test Circuit Figure 4, Page 1-2

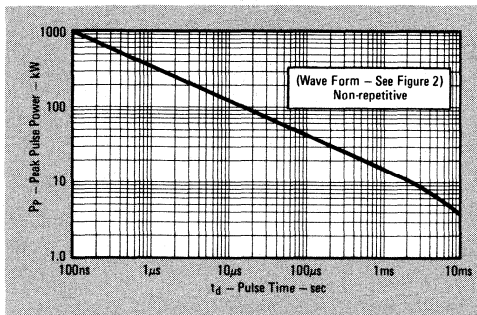
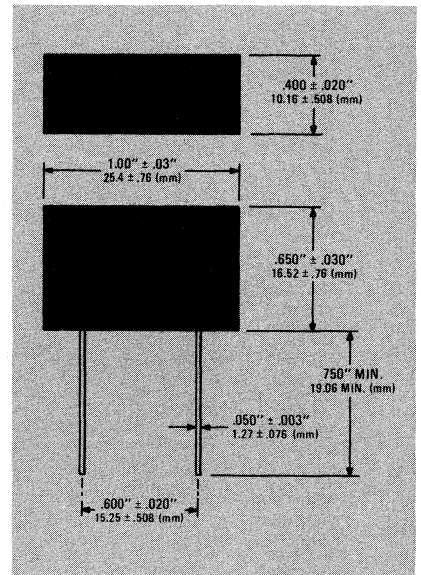
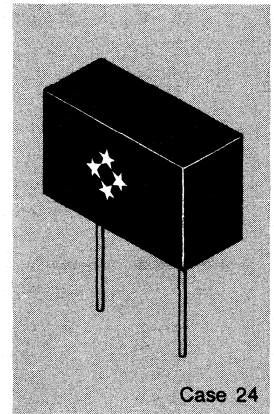

Peak Pulse Power vs Pulse Time

ELECTRICAL CHARACTERISTICS @ 25°C

GENERAL SEMICONDUCTOR PART NUMBER	REVERSE STAND-OFF VOLTAGE (Note 1) V_R VOLTS	BREAKDOWN VOLTAGE		I_T mA	MAXIMUM CLAMPING VOLTAGE @ I_{PP} (1 mSEC) V_C VOLTS	MAXIMUM REVERSE LEAKAGE @ V_R I_R μA	MAXIMUM PEAK PULSE CURRENT (Fig. 2) I_{PP} A	MAXIMUM VOLTAGE TEMPERATURE VARIATION OF BV mV/°C
		BV @	I_T					
15KP17	17	18.9	23.1	50	32.3	5000	464	19
15KP17A	17	18.9	20.9	50	29.3	5000	512	17
15KP18	18	20.0	24.4	50	34.2	5000	439	20
15KP18A	18	20.0	22.1	50	30.9	5000	485	18
15KP20	20	22.2	27.1	20	37.9	1500	396	24
15KP20A	20	22.2	24.5	20	34.3	1500	437	21
15KP22	22	24.4	29.8	10	41.1	500	365	27
15KP22A	22	24.4	26.9	10	37.1	500	404	24
15KP24	24	26.7	32.6	5	45.0	150	333	30
15KP24A	24	26.7	29.5	5	40.7	150	369	27
15KP26	26	28.9	35.3	5	48.7	50	308	32
15KP26A	26	28.9	31.9	5	44.0	50	341	29
15KP28	28	31.1	38.0	5	52.4	25	286	35
15KP28A	28	31.1	34.4	5	47.5	25	316	31
15KP30	30	33.3	40.7	5	56.2	15	267	27
15KP30A	30	33.3	36.8	5	50.7	15	296	34
15KP33	33	36.7	44.9	5	60.6	10	248	42
15KP33A	33	36.7	40.6	5	54.8	10	274	38
15KP36	36	40.0	48.9	5	66.0	10	227	46
15KP36A	36	40.0	44.2	5	59.7	10	251	41
15KP40	40	44.4	54.3	5	72.8	10	206	51
15KP40A	40	44.4	49.1	5	65.8	10	228	46
15KP43	43	47.8	58.4	5	77.1	10	195	55
15KP43A	43	47.8	52.8	5	69.7	10	215	50
15KP45	45	50.0	61.1	5	80.7	10	186	57
15KP45A	45	50.0	55.3	5	73.0	10	205	52
15KP48	48	53.3	65.1	5	85.9	10	175	62
15KP48A	48	53.3	58.9	5	77.7	10	193	56
15KP51	51	56.7	69.3	5	91.5	10	164	66
15KP51A	51	56.7	62.7	5	82.8	10	181	60
15KP54	54	60.0	73.3	5	96.8	10	155	70
15KP54A	54	60.0	66.3	5	87.5	10	171	63
15KP58	58	64.4	78.7	5	104.0	10	144	76
15KP58A	58	64.4	71.2	5	94.0	10	160	68
15KP60	60	66.7	81.5	5	107.0	10	140	78
15KP60A	60	66.7	73.7	5	97.3	10	154	71
15KP64	64	71.1	86.9	5	115	10	130	84
15KP64A	64	71.1	78.6	5	104	10	144	76
15KP70	70	77.8	95.1	5	126	10	119	92
15KP70A	70	77.8	86.0	5	114	10	132	83
15KP75	75	83.3	102.0	5	135	10	111	100
15KP75A	75	83.3	92.1	5	122	10	123	89
15KP78	78	86.7	106.0	5	140	10	107	104
15KP78A	78	86.7	95.8	5	126	10	119	93
15KP85	85	94.4	115	5	152	10	99	113
15KP85A	85	94.4	104	5	137	10	109	102
15KP90	90	100.0	122	5	160	10	94	120
15KP90A	90	100.0	111	5	146	10	103	109
15KP100	100	111	136	5	179	10	84	134
15KP100A	100	111	123	5	162	10	93	121
15KP110	110	122	149	5	196	10	77	147
15KP110A	110	122	135	5	178	10	84	133
15KP120	120	133	163	5	214	10	70	161
15KP120A	120	133	147	5	193	10	78	145
15KP130	130	144	176	5	231	10	65	174
15KP130A	130	144	159	5	209	10	72	157
15KP150	150	167	204	5	268	10	56	202
15KP150A	150	167	185	5	243	10	62	183
15KP160	160	178	218	5	287	10	52	216
15KP160A	160	178	197	5	259	10	58	195
15KP170	170	189	231	5	304	10	49	229
15KP170A	170	189	209	5	275	10	55	207
15KP180	180	200	244	5	321	10	47	242
15KP180A	180	200	221	5	291	10	52	219
15KP200	200	222	271	5	366	10	42	269
15KP200A	200	222	245	5	322	10	47	243
15KP220	220	245	299	5	393	10	38	297
15KP220A	220	245	271	5	356	10	42	269
15KP240	240	267	326	5	428	10	35	324
15KP240A	240	267	295	5	388	10	39	293
15KP260	260	289	353	5	464	10	32	352
15KP260A	260	289	319	5	419	10	36	317
15KP280	280	311	380	5	500	10	30	378
15KP280A	280	311	344	5	452	10	33	342

$V_f = 7.5 V @ 200A, 8.3 msec/1/2$ sine wave

Note 1: A TransZorb is normally selected according to the reverse "Stand Off Voltage" (V_R) which should be equal to or greater than the DC or continuous peak operating voltage level.



**GENERAL
SEMICONDUCTOR
INDUSTRIES, INC.**

**BIDIRECTIONAL
TRANSZORB[®]
TRANSIENT VOLTAGE
SUPPRESSOR
60KS200C**

**1
TRANSZORBs**

DESCRIPTION

... a Bidirectional Silicon Transient Suppressor for use in shipboard equipment and other power servicing equipment where large voltage transients endanger voltage sensitive components. The TransZorb meets all applicable environmental requirements of MIL-S-19500 and is consistent with MIL-E-16400. These devices were designed with MIL-STD-1399 Section 103 (Interface standard for shipboard systems, Electrical power, Alternating current) as the controlling specification.

- 200 Volt Bidirectional
- Exceeds MIL-STD-1399 requirements
- Can be supplied with JAN/JANTX parts

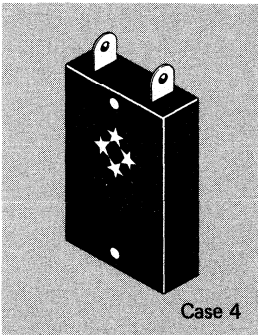

MAXIMUM RATINGS

- 15,000 watts Peak Pulse Power dissipation at 25°C
- Steady State power dissipation: 10 watts
- Operating and Storage temperatures: -65° to +150°C
- $t_{clamping}$ (0 volts to BV): Less than 1×10^{-8} seconds

CAPACITANCE

- 170 pF @ 0 Volts (Typical)

Power-Temperature Derating Curve. Figure 3, Page 1-1

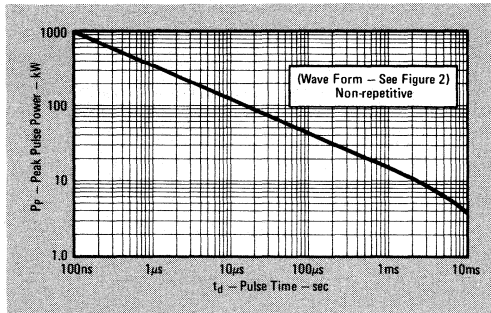

Peak Pulse Power vs Pulse Time

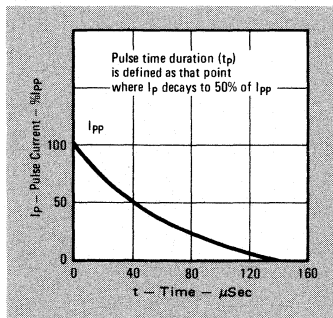

**Pulse Wave Form
(1.5 x 40 μSec)**

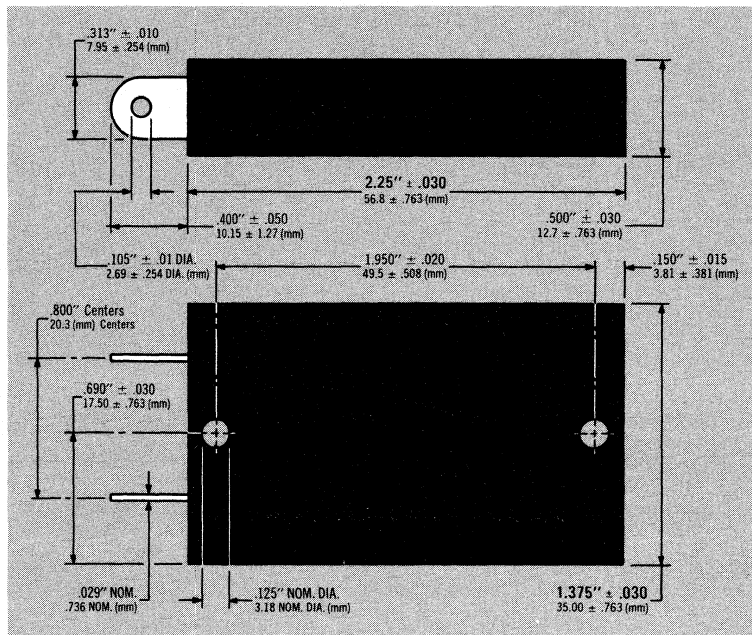

ELECTRICAL CHARACTERISTICS @ 25°C (Test Both Polarities)*

GENERAL SEMICONDUCTOR PART NUMBER	REVERSE STAND-OFF VOLTAGE (Note 1) V_R	MAXIMUM REVERSE LEAKAGE @ V_R	BREAKDOWN VOLTAGE @ 1 mA		MAXIMUM CLAMPING VOLTAGE @ I_{PP}	MAXIMUM PEAK PULSE CURRENT (Pulse Wave Form - Pg. 1-19)
	VOLTS	I_R μA	Min.	Max.	V_C VOLTS	I_{PP} A
60KS200C	180	10	200	225	335	180

*Intermediate voltages available upon request. Consult factory.

Note 1: A TransZorb is normally selected according to the reverse "Stand Off Voltage" (V_R) which should be equal to or greater than the DC or continuous peak operating voltage level.

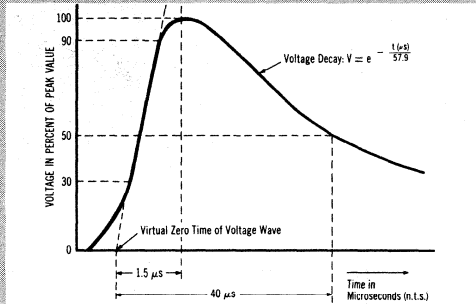

FIGURE 1 - Spike Voltage (Short Time Transient) Wave Shape

MIL-STD-1399, Section 103 does not define or specify source impedance of the transient wave form depicted in Fig. 1, Page 10 (see GSI Figure 1). However, Naval Ship Engineering Center has as of 26 Nov. 1975 issued guidelines which are meaningful in determining the transient source impedance.

... a computer study had been made of shipboard electrical systems and an average of the data calculated was:

- R = 3.5 ohms resistance of system under transient conditions
- X_L = 10 ohms @ 167 KHz - reactance of system under transient conditions
- Freq_u = 165 KHz to 250 KHz - The slope of the voltage wave at these frequencies is approximately the same as the leading edge of the spike voltage wave in MIL-STD-1399 Sec 103 Fig. 1 on Page 10
- V = 2500 volts - spike voltage amplitude

Additional calculations were made concerning the surge or characteristic impedance of the system.

$$Z_0 = 16\Omega \text{ to } 26\Omega$$

General Semiconductor has subjected the 60KS200C TransZorb to pulses generated by a special transient simulator (schematic shown in Figure 2). Figure 3 is the current pulse wave form monitored at point A and Figure 4 is the voltage for the device under test monitored at point C.

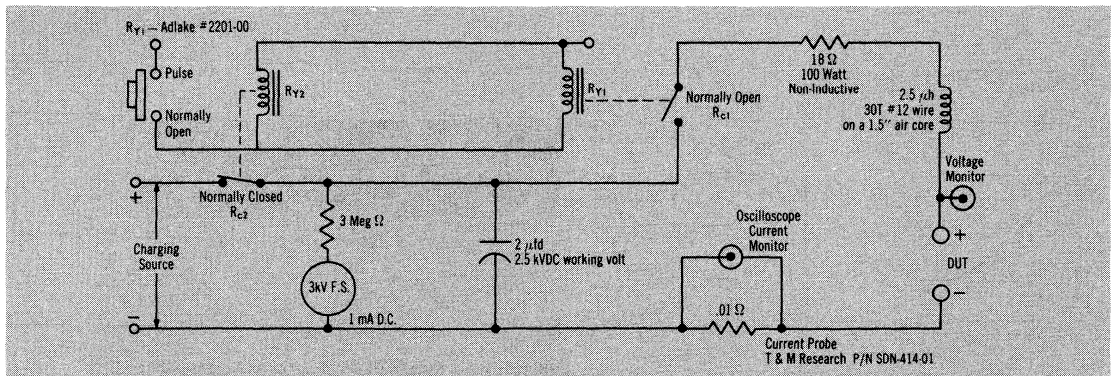

FIGURE 2 - Test Circuit for 60KS200C

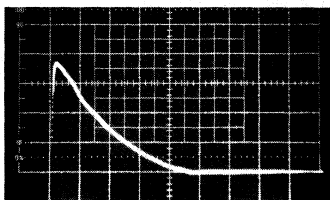

FIGURE 3 - Current Pulse Wave Form
Vertical: 50A/cm
Horizontal: 20 μsec/cm

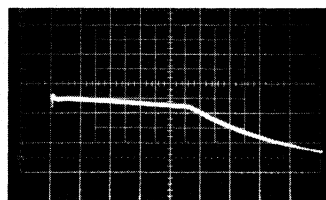

FIGURE 4 - Voltage Pulse Wave Form With TransZorb Under Test
Vertical: 100V/cm
Horizontal: 20 μsec/cm



**GENERAL
SEMICONDUCTOR
INDUSTRIES, INC.**

TRANSZORB[®]
TRANSIENT VOLTAGE
SUPPRESSORS
704-15K36
704-15K36T

1
TRANSZORB

DESCRIPTION

... a series of Silicon Transient Suppressors for use primarily in Airborne Equipment where large voltage transients endanger voltage sensitive components. The TransZorb meets all applicable environmental requirements of MIL-S-19500.

These devices were designed with MIL-STD-704 (Characteristics and Utilization of Aircraft Electric Power) as the controlling specification. These 15kW assemblies are designed typically to operate with a minimum source impedance of .25 Ohms for transients.

- Designed for MIL-STD-704
- 28 volt power supply protection
- Can be supplied with JAN/JANTX parts

MECHANICAL CHARACTERISTICS

- Molded Case
- Polarity: Positive terminal indicated
- Weight: 704-15K36 – 38 grams
704-15K36T – 65 grams
- Body marked with Logo * and type number

MAXIMUM RATINGS

- Peak Pulse Power dissipation at 25°C: 15,000 watts at 1 msec
- Steady State power dissipation: 10 watts
- $t_{clamping}$ (0 volts to BV min): Less than 1×10^{-12} seconds
- Operating and Storage temperatures: -65° to +150°C
- Forward surge rating: 300 amps, 1/120 second at 25°C
- Duty cycle: .01%

Pulse Wave Form Figure 2, Page 1-1
Capacitor Discharge Test Circuit Figure 4, Page 1-2

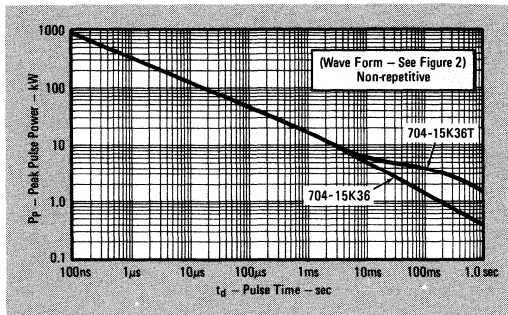
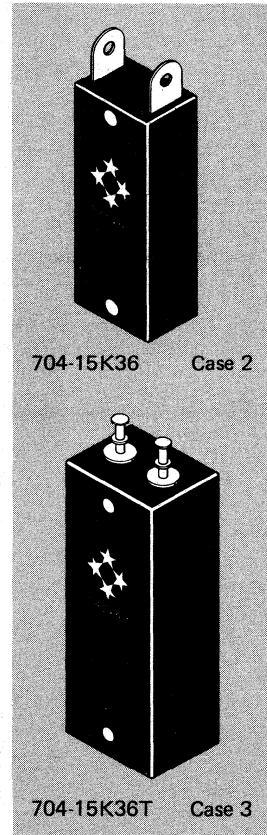

Peak Pulse Power vs Pulse Time

ELECTRICAL CHARACTERISTICS @ 25°C

GENERAL SEMICONDUCTOR PART NUMBER	REVERSE STAND-OFF VOLTAGE (Note 1) V_R VOLTS	MAXIMUM REVERSE LEAKAGE @ V_R I_R μA	MINIMUM BREAKDOWN VOLTAGE @ 10 mA BV VOLTS	MAXIMUM CLAMPING VOLTAGE @ I_{PP} V_C VOLTS	MAXIMUM PEAK PULSE CURRENT (Fig. 2) I_{PP} A	MAXIMUM FORWARD VOLTAGE V_F @ ~ 8.3 msec. 100 A Volts DC
704-15K36	31.5	100	36	51	300	3.0
704-15K36T	31.5	500	36	51	300	15.0

Note 1: A TransZorb is normally selected according to the reverse "Stand Off Voltage" (V_R) which should be equal to or greater than the DC or continuous peak operating voltage level.

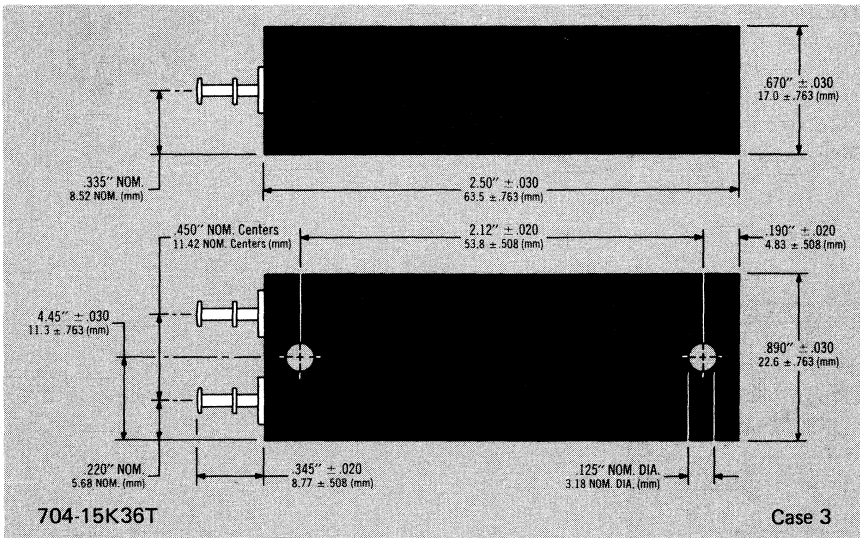
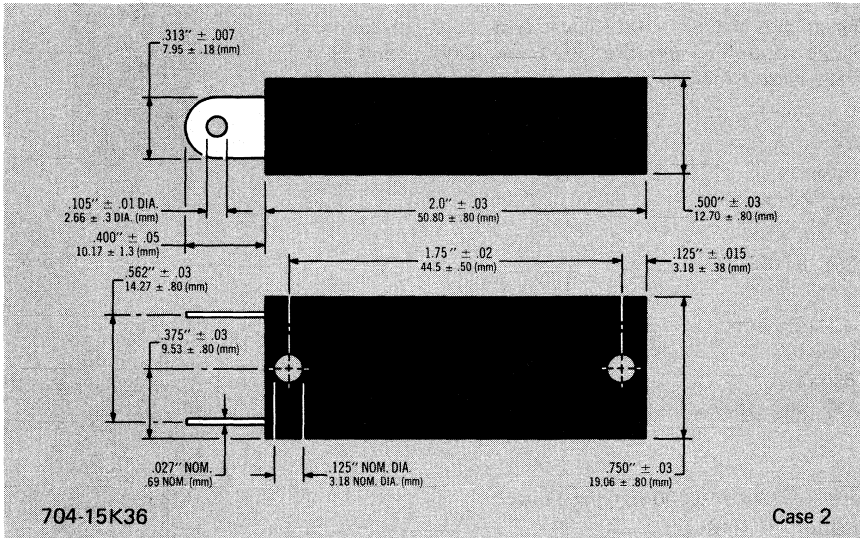



**GENERAL
SEMICONDUCTOR
INDUSTRIES, INC.**

**TRANSZORB™
GMP-5
SERIES**

1

TRANSZORBS

LOW VOLTAGE TRANSZORB FOR 5.0V MEMORIES

The GMP-5 series is a premium 500 watt transient voltage suppressor designed for low voltage protection of MOS memories. Because of the low clamping factor, they provide a high degree of protection to VMOS, HMOS, NMOS, and CMOS circuits susceptible to 5-volt line transients. The TransZorb is desired over and above a crowbar circuit which can be false triggered and must be turned off to reset.

TransZorbs are characterized by their high surge capability, extremely fast response time and low on resistance. They are effective in providing protection against pulses generated by electromechanical switching, electromagnetic coupling, capacitive or inductive load switching, voltage reversals and electrostatic discharge. MOS circuits are more prone to damage from these pulses.

External system disturbances, such as electrostatic discharges, result in transient voltages exceeding 20,000 volts. TransZorbs having a low-series resistance (R_{ON}) will effectively shut out unwanted transients while maintaining the circuit voltage level for continuous system operation.

Other low-cost TransZorbs are available for applications not requiring the level of protection characterized by this series, see our MPT-5 and MPT-5 data sheets. The MPT-5 series TransZorbs are designed for Military and other Aerospace requirements.

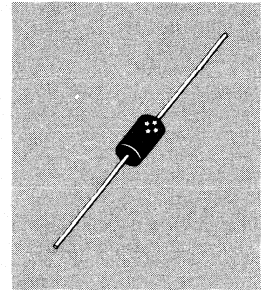

- Static memory protector
- Transient protection for CMOS, MOS

MAXIMUM RATINGS

- 500 Watts of Peak Pulse Power dissipation at 25°C
- $t_{clamping}$ (0 volts to BV min): Less than 1×10^{-12} seconds (theoretical)
- Operating and Storage Temperatures: -65°C to +175°C
- Forward surge rating: 100 amps, $1/120$ second at 25°C
- Steady State power dissipation: 5.0 W @ $T_L = 75^\circ\text{C}$, Lead Length = $3/8$ "
- Repetition rate (duty cycle): .05%

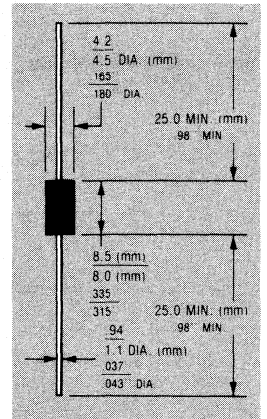

MECHANICAL CHARACTERISTICS

- Molded Case
- Weight: 1.5 grams (approximate)
- Positive terminal marked with band
- Body marked with Logo  and type number

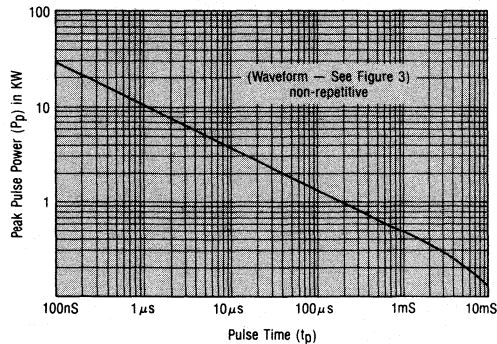

FIGURE 1 — Peak Pulse Power vs Pulse Time

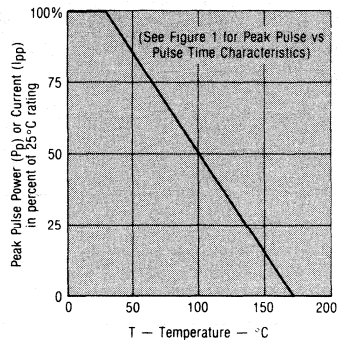

FIGURE 2 — Derating Curve

GENERAL SEMICONDUCTOR INDUSTRIES, INC.

ELECTRICAL CHARACTERISTICS @ 25°C

GENERAL SEMI-CONDUCTOR TYPE NUMBER	STAND-OFF VOLTAGE Note 1 V_R Volts	MAXIMUM REVERSE LEAKAGE @ V_R I_F μA	MINIMUM BREAKDOWN VOLTAGE @ $I_m A$ BV(min) Volts	MAXIMUM CLAMPING VOLTAGE @ $I_{pp1} = 1 A$ Note 2 (Fig. 3) B_C Volts	MAXIMUM CLAMPING VOLTAGE @ $I_{pp2} = 10 A$ Note 2 (Fig. 3) B_C Volts	MAXIMUM PEAK PULSE CURRENT Note 2 (Fig. 3) I_{pp3} Amps	MAXIMUM PEAK PULSE CURRENT ($1.2 \times 50 \mu sec$) Amps
GMP-5	5.0	300	5.3	6.7	6.9	70	215
GMP-5A	5.0	100	5.5	6.7	6.9	70	215
GMP-5B	5.0	300	5.3	6.4	6.6	70	215

V_f at 50 AMPS PEAK, 8.3 MSEC SINE WAVE equals 3.5 VOLTS MAXIMUM.

Note 1: A TransZorb is normally selected according to the reverse "Stand Off Voltage" (V_R) which should be equal to or greater than the DC or continuous peak operating voltage level.

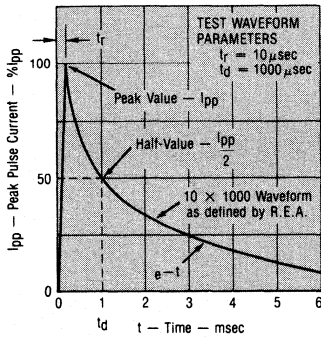

FIGURE 3 — Pulse Wave Form

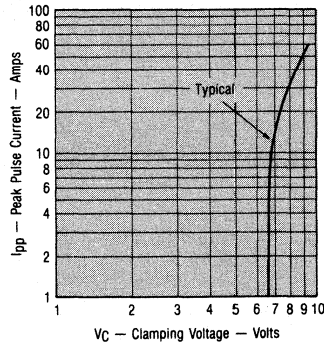

FIGURE 4 — Typical Characteristic Clamping Voltage (V_C) vs Peak Pulse Current (I_{pp})

Capacitor Discharge Circuit for Testing TransZorbs

Note 2:

The most significant electrical characteristic of transient suppressors is the surge handling capability. All TransZorbs are subjected 100% to the Maximum Peak Pulse Current (I_{pp}) as indicated in the electrical characteristic table and the clamping voltage is monitored. This test should be part of the customer's quality control incoming inspection procedure.

RECOMMENDED PULSE CIRCUITRY

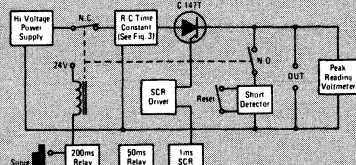

ALTERNATE CIRCUITRY

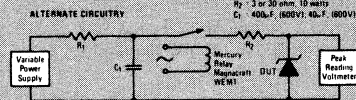

PRODUCT GUIDE MEMORIES

	RAM	INTEL	T.I.	AMD	ZILOG	MOSTEK	HARRIS	RCA	AMI
HMOS		2114 2147 2141							
NMOS			4044/4046 4244 4245	AM9114	26104 26132	4801 4104			
CMOS							HM6504 HM6514	MNS5114 CDP1825	
VMOS									4017
64K RAMS			TMS4104			MK4164			
EPROM		2716 2732							



**GENERAL
SEMICONDUCTOR
INDUSTRIES, INC.**

TRANSZORB™
TRANSIENT VOLTAGE
SUPPRESSORS
ICT-5
THRU
ICT-45C

1

TRANSZORB

DESCRIPTION

... a premium series of transient voltage suppressors specifically designed and tested to protect Bipolar, MOS and Schottky improved integrated circuits from electrical disturbances. Transients and noise pulses are generated by electromechanical switching, electromagnetic coupling, capacitive or inductive load switching, voltage reversals, and electrostatic discharge. The TransZorb is desired over and above a crowbar circuit, an LC or RC network and a catch or clamping diode because of fewer components, speed of response, high power or energy absorption and low clamping ratio.

- Transient protection for CMOS, MOS, BIPOLAR, ICs, (TTL, ECL, DTL, RTL and Linear Functions)
- Voltage range of 5.0 to 45 volts
- Low clamping ratio

MAXIMUM RATINGS

- 1500 Watts of Peak Pulse Power dissipation at 25°C
- $t_{clamping}$ (0 volts to BV min): Unipolar – Less than 1×10^{-12} seconds
Bidirectional – Less than 5×10^{-9} seconds
- Operating and Storage temperatures: -65° to +175°C
- Forward surge rating: 200 amps, 1/120 second at 25°C
(Applies to Unipolar or single direction only)
- Steady State power dissipation: 1.0 watt
- Repetition rate (duty cycle): .01%

MECHANICAL CHARACTERISTICS

- Standard DO-13 package, glass and metal hermetically sealed
- Weight. 1.5 grams (approximate)
- Positive terminal marked with band (except Bidirectional types)
- Body marked with Logo and type number
- Unipolar – std polarity – cathode to case

ELECTRICAL CHARACTERISTICS

- Clamping Factor: 1.33 @ Full rated power
1.20 @ 50% rated power

Clamping Factor: The ratio of the actual V_C (Clamping Voltage) to the actual BV (Breakdown Voltage) as measured on a specific device.
(See Figure 2, Page 1-1 for Test Pulse Wave Shape.)

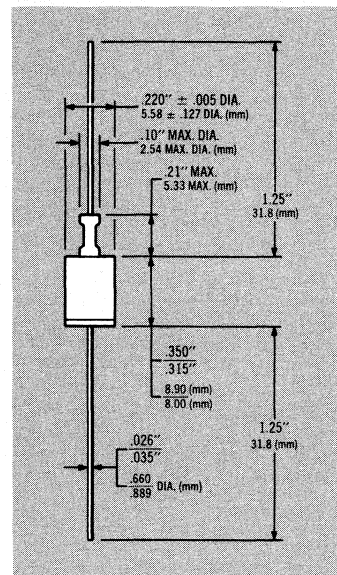
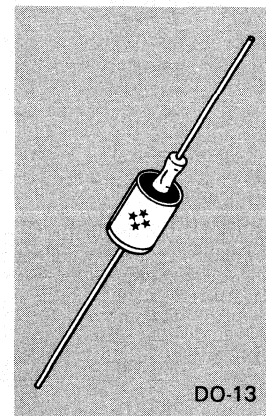

- Peak Pulse Power vs Pulse Time. Figure 1, Page 1-1
- Pulse Wave Form. Figure 2, Page 1-1
- Power-Temperature Derating Curve. Figure 3, Page 1-1
- Capacitor Discharge Test Circuit Figure 4, Page 1-2

ELECTRICAL CHARACTERISTICS @ 25°C

GENERAL SEMICONDUCTOR PART NUMBER	STAND-OFF VOLTAGE (Note 1) V_R VOLTS	MAXIMUM REVERSE LEAKAGE @ V_R I_R μA	MINIMUM* BREAKDOWN VOLTAGE @ 1 mA BV(min) VOLTS	MAXIMUM CLAMPING VOLTAGE (Fig. 2) @ $I_{PP1} = 1A$ V_C VOLTS	MAXIMUM CLAMPING VOLTAGE (Fig. 2) @ $I_{PP2} = 10A$ V_C VOLTS	MAXIMUM PEAK PULSE CURRENT I_{PP3} A
ICT-5	5.0	300	6.0	7.1	7.5	160
ICT-8	8.0	25	9.4	11.3	11.5	100
ICT-10	10.0	2	11.7	13.7	14.1	90
ICT-12	12.0	2	14.1	16.1	16.5	70
ICT-15	15.0	2	17.6	20.1	20.6	60
ICT-18	18.0	2	21.2	24.2	25.2	50
ICT-22	22.0	2	25.9	29.8	32.0	40
ICT-36	36.0	2	42.4	50.6	54.3	23
ICT-45	45.0	2	52.9	63.3	70.0	19

V_f at 100 amps peak, 8.3 msec sine wave equals 3.5 volts maximum

ELECTRICAL CHARACTERISTICS @ 25°C (Test Both Polarities)

ICT-8C	8.0	25	9.4	11.4	11.6	100
ICT-10C	10.0	2	11.7	14.1	14.5	90
ICT-12C	12.0	2	14.1	16.7	17.1	70
ICT-15C	15.0	2	17.6	20.8	21.4	60
ICT-18C	18.0	2	21.2	24.8	25.5	50
ICT-22C	22.0	2	25.9	30.8	32.0	40
ICT-36C	36.0	2	42.4	50.6	54.3	23
ICT-45C	45.0	2	52.9	63.3	70.0	19

C Suffix indicates Bipolar

ICT-5 not available as Bipolar

Note 1: A TransZorb is normally selected according to the reverse "Stand Off Voltage" (V_R) which should be equal to or greater than the DC or repetitive peak operation voltage level.

*The minimum breakdown voltage as shown takes into consideration the ± 1 volt tolerance normally specified for power supply regulation on most integrated circuit manufacturers data sheets. Similar TransZorb devices are available with reduced clamping voltages where tighter regulated power supply voltages are employed.

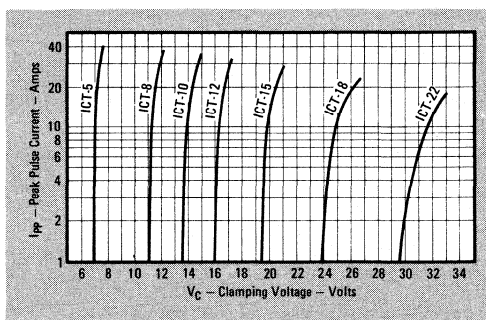

Typical Characteristic Clamping Voltage vs Peak Pulse Current

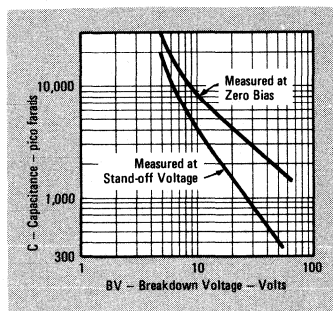

Typical Capacitance vs Breakdown Voltage (Unipolar Types)

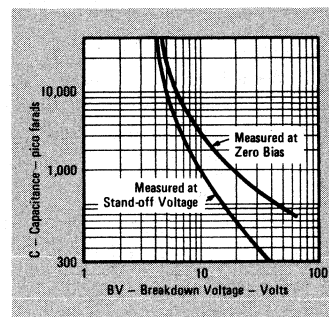

Typical Capacitance vs Breakdown Voltage (Bipolar Types)

APPLICATION NOTES

The ICT series TransZorb is characterized by the reverse stand-off voltage (V_R). It is synonymous with the integrated circuit power supply voltage. The breakdown voltage (BV) is that point at which the TransZorb is in avalanche breakdown.

This point is temperature dependent and has a positive temperature coefficient. Allowance has been made in establishing the minimum breakdown voltage at 25°C to provide safe operation over the full military temperature range.

DC LINE APPLICATIONS

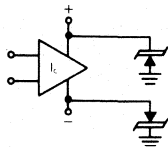

The TransZorb on the power line prevents IC failures caused by transients (electrostatic charge), power supply reversals or during switching of the power supply to on or off.

Typical power sources employing the TransZorb for Voltage Transient Protection.

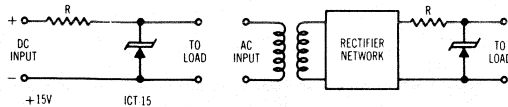

The TransZorb is chosen in which the reverse stand-off voltage is equal to or greater than the DC output voltage. For certain applications it may be more desirable to replace the series resistor (R) with an inductor. In most applications, a fuse in the line is desirable. Elimination of a transformer will require an LC filter on the line for most industrial applications, when the TransZorb is placed on the input to the power supply and with an input voltage greater than 40 volts.

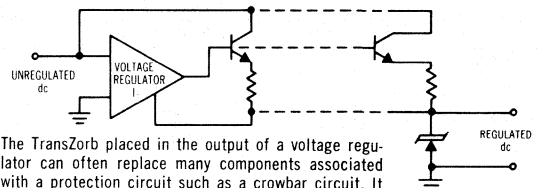

The TransZorb placed in the output of a voltage regulator can often replace many components associated with a protection circuit such as a crowbar circuit. It may also be required to protect the bypass transistor from voltage spikes across the collector to emitter terminals.

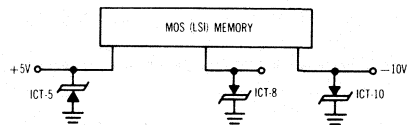

The TransZorbs protect the internal MOS FET from transients introduced on the power supply line. When interfaced with bipolar TTL circuits, the same power supply is often used. A common practice is to place a series protection diode from source to gate, but this does not offer protection from source to ground and is usually limited on peak power dissipation. A TransZorb is required on each voltage supply line to the integrated circuit.

SIGNAL LINE APPLICATION

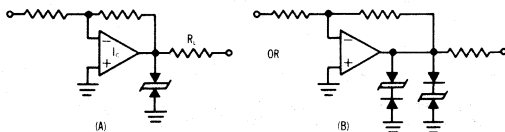

A TransZorb on the output of an Op-amp will prevent a voltage transient, due to a short circuit or an inductive load, from being transmitted into the output stage. Fig. A is for linear circuits whereas Fig. B may be required for reducing effective capacity at the output. The TransZorb and a blocking diode is available as a single unit.

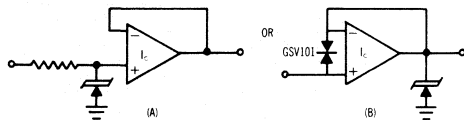

Input stages are vulnerable to low energy, high voltage static discharges or crosstalk transmitted on the signal wires. Limited protection is provided by the clamp diode or an input network within the IC substrate. The diodes, however, must have a breakdown voltage greater than the supply voltage (V_{CC}) and are limited in current capacity.

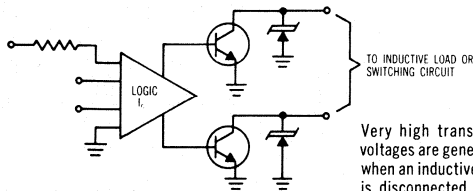

Very high transients voltages are generated when an inductive load is disconnected, such as motors, relay coils and solenoids. The TransZorb provides protection for the output transistor as well as the IC, eliminating a resistor/capacitor network.

The ICT series TransZorb is capable of dissipating the full load current for short duration pulses (<8.3 msec). For longer pulses, the TransZorb is available in stud or press fit package.

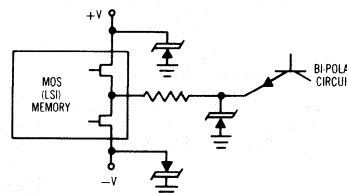

Totem pole output circuits often generate current spikes requiring decoupling capacitors. While maintaining circuit continuity, the TransZorb is capable of absorbing the

energy pulse as well as eliminating noise spikes due to such things as crosstalk, etc. A clamp diode in the IC substrate is limited in conduction current, <100 ma, providing a minimum protection. For high frequency applications a special designed TransZorb is available upon request.

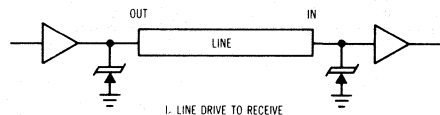

Transients generated on the line can vary from a few microseconds to several milliseconds duration and up to 10,000 volts. This threat of potential energy has given rise to high noise immunity integrated circuits. An independent study* has found that high immunity and super high immunity circuits are prone to damage by noise transients as a result of the power being dissipated by the substrate input diode. Excess current passing through the input diode can cause an open circuit condition or a slow degradation of the circuit performance. TransZorbs located on the signal line can absorb this excess energy. For some circuit applications a low capacitance unit may be required, which is available upon request.

*The Radio & Electronic Engineer, Vol. 43, No. 4, April 1973

TransZorbs can be used in series or parallel to increase their power handling capability. No precautions are required when using TransZorbs in a series string since power dissipation for two or more devices of the same type is equally shared. When using TransZorbs in parallel it is necessary for the units to be closely matched (approx. .1 volt of each other) in order for equal sharing to take place. Matched sets can be ordered from the factory for an additional charge.

DIGITAL IC's

CMOS — MOS — BIPOLAR

The TransZorb type (s) listed under each integrated circuit manufacturer's series is the recommended transient voltage suppressor for power supply protection. Similar types may also be used for direct signal line protection. Special low capacitance TransZorbs for high frequency applications are available upon request.

	RCA	SSS	SOLITRON		
CMOS	*CD4000 A (ICT-5, -10) (ICT-15)	SCL4000 (ICT-5, -10) (ICT-15)	CM 4000 (ICT-5, -10) (ICT-15)		
	FAIRCHILD	MOTOROLA	TI	NATIONAL	SIGNETICS
MOS	3100 thru 3801 (ICT-36)	MC1120 (Series) (ICT-36)	*TMS Series (ICT-5, -12, -15, -22, -36)	*MM421/521	*1101/1402 (ICT-5, -12, -15)
TTL	*9300	MC9300		*8000	8000/MSI (ICT-5)
	9N00	MC5400/7400 Series (ICT-5)	*5400/7400 (ICT-5)	DM54L/74L (Series) (ICT-5)	\$5400 (ICT-5)
	9H00	MC54H00	*SN54/74H *SN54L/74L *SN545/745	DM54H00 DM54L02	\$54H00 (ICT-5)
TT_μL	*9000 Series (ICT-5)	MC7400		DM9002	
HTL	*9100	MC660 Series (ICT-15)			
DTL	*9930 *9093 *930 (ICT-5)	MC930 (ICT-5)	SN15930 (ICT-5)	DM930 (ICT-5)	
ECL	9500	*MECL II MC1000/1200 Series (ICT-5)			N1004

*When using TransZorb devices for protection, the user should differentiate between the continuous voltage ratings and the maximum pulse voltage rating, as specified by various manufacturers. (For example see Motorola data sheet MDTLMC830/930.) Recommended device types may have to be replaced with intermediate voltage levels as specific application for an IC varies.

LINEAR IC's

TransZorb protection for Linear IC devices will vary with each application. Specific device types are, however, listed for each IC manufacturer. The recommended TransZorb type corresponds to the power supply voltage, with the exception of the voltage regulator.

	FAIRCHILD	MOTOROLA	RCA	SIGNETICS
Operational Amplifiers	A7XX Series (ICT-5, -12, -15, -22)	MC153X Series (ICT-5, -12, -18)	CA3060/80 (ICT-5, -12, -18) CA34XX CA37XX Series (ICT-15)	SE516 (ICT-36) LM101A (ICT-18, -22) NE53X (ICT-15, -22) N5556
Voltage Regulator	SH3200 (ICT-22, -26)	MC1560/1 (ICT-18)	CA3085 (Various ICT types)	550 (ICT-45)
Analog Voltage Comparator				527 (ICT-5, -15)
Differential Amplifier		MC1519/25/26 (ICT-12)	CA3000 (ICT-5, -12)	A733 (ICT-8)
Power Driver Amplifier		MC1554 (ICT-8, -15)		540
Sense Amplifier		MC1514/40/41 (ICT-5, -12)	CA35410 (ICT-5, -10)	



**GENERAL
SEMICONDUCTOR
INDUSTRIES, INC.**

TRANSZORB
TRANSIENT VOLTAGE
SUPPRESSORS
ICTE-5
THRU
ICTE-45C

1

TRANSZORB88

DESCRIPTION

... a premium series of transient voltage suppressors specifically designed and tested to protect Bipolar, MOS and Schottky improved integrated circuits from electrical disturbances. Transients and noise pulses are generated by electromechanical switching, electromagnetic coupling, capacitive or inductive load switching, voltage reversals, and electrostatic discharge. The TransZorb is desired over and above a crowbar circuit, an LC or RC network and a catch or clamping diode because of fewer components, speed of response, high power or energy absorption and low clamping ratio.

- Transient protection for CMOS, MOS, BIPOLAR, ICs, (TTL, ECL, DTL, RTL and Linear Functions)
- Voltage range of 5.0 to 45 volts
- Low clamping ratio

MAXIMUM RATINGS

- 1500 Watts of Peak Pulse Power dissipation at 25°C
- $t_{clamping}$ (0 volts to BV min): Unipolar – Less than 1×10^{-12} seconds
Bidirectional – Less than 5×10^{-9} seconds
- Operating and Storage temperatures: -65° to +175°C
- Forward surge rating: 200 amps, 1/120 second at 25°C
(Applies to Unipolar or single direction only)
- Steady State power dissipation: 5.0 watts @ $T_L = 75^\circ C$, Lead Length = 3/8"
- Repetition rate (duty cycle): .05%

MECHANICAL CHARACTERISTICS

- Molded case
- Weight: 1.5 grams (approximate)
- Positive terminal marked with band (except Bidirectional types)
- Body marked with Logo * and type number

ELECTRICAL CHARACTERISTICS

- Clamping Factor: 1.33 @ Full rated power
1.20 @ 50% rated power

Clamping Factor: The ratio of the actual V_C (Clamping Voltage) to the actual BV (Breakdown Voltage) as measured on a specific device. (See Figure 2, Page 1-1 for Test Pulse Wave Shape.)

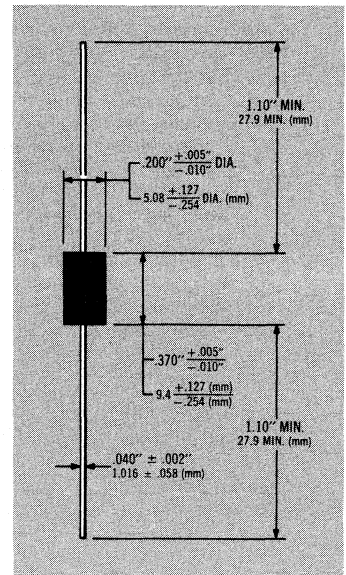
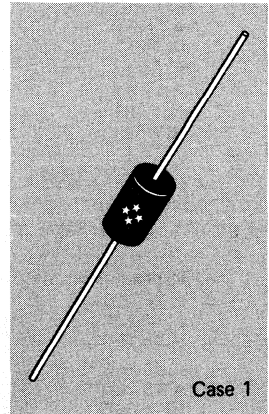

- Peak Pulse Power vs Pulse Time. Figure 1, Page 1-1
- Pulse Wave Form. Figure 2, Page 1-1
- Power-Temperature Derating Curve. Figure 3, Page 1-1
- Capacitor Discharge Test Circuit. Figure 4, Page 1-2

ELECTRICAL CHARACTERISTICS @ 25°C

GENERAL SEMICONDUCTOR PART NUMBER	STAND-OFF VOLTAGE (Note 1) V_R VOLTS	MAXIMUM REVERSE LEAKAGE @ V_R I_R μA	MINIMUM * BREAKDOWN VOLTAGE @ 1 mA BV(min)	MAXIMUM CLAMPING VOLTAGE (Fig. 2) @ $I_{PP1} = 1A$ V_C VOLTS	MAXIMUM CLAMPING VOLTAGE (Fig. 2) @ $I_{PP2} = 10A$ V_C VOLTS	MAXIMUM PEAK PULSE CURRENT I_{PP3} A
ICTE-5	5.0	300	6.0	7.1	7.5	160
ICTE-8	8.0	25	9.4	11.3	11.5	100
ICTE-10	10.0	2	11.7	13.7	14.1	90
ICTE-12	12.0	2	14.1	16.1	16.5	70
ICTE-15	15.0	2	17.6	20.1	20.6	60
ICTE-18	18.0	2	21.2	24.2	25.2	50
ICTE-22	22.0	2	25.9	29.8	32.0	40
ICTE-36	36.0	2	42.4	50.6	54.3	23
ICTE-45	45.0	2	52.9	63.3	70.0	19

V_f at 100 amps peak, 8.3 msec sine wave equals 3.5 volts maximum

ELECTRICAL CHARACTERISTICS @ 25°C (Test Both Polarities)

ICTE-8C	8.0	25	9.4	11.4	11.6	100
ICTE-10C	10.0	2	11.7	14.1	14.5	90
ICTE-12C	12.0	2	14.1	16.7	17.1	70
ICTE-15C	15.0	2	17.6	20.8	21.4	60
ICTE-18C	18.0	2	21.2	24.8	25.5	50
ICTE-22C	22.0	2	25.9	30.8	32.0	40
ICTE-36C	36.0	2	42.4	50.6	54.3	23
ICTE-45C	45.0	2	52.9	63.3	70.0	19

C Suffix indicates Bipolar

ICTE-5 not available as Bipolar

Note 1: A TransZorb is normally selected according to the reverse "Stand Off Voltage" (V_R) which should be equal to or greater than the DC or continuous peak operating voltage level.

*The minimum breakdown voltage as shown takes into consideration the ± 1 volt tolerance normally specified for power supply regulation on most integrated circuit manufacturers data sheets. Similar TransZorb devices are available with reduced clamping voltages where tighter regulated power supply voltages are employed.

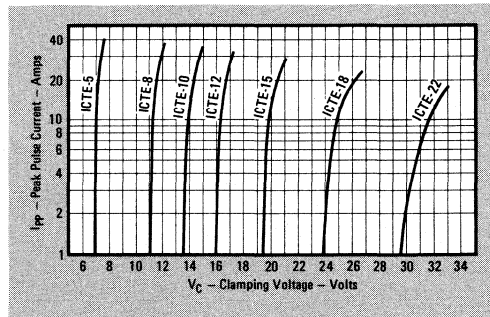

Typical Characteristic Clamping Voltage vs Peak Pulse Current

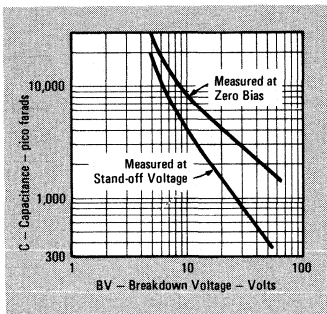

Typical Capacitance vs Breakdown Voltage (Unipolar Types)

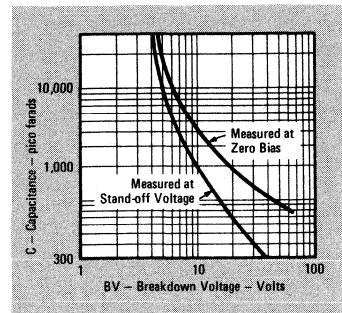

Typical Capacitance vs Breakdown Voltage (Bipolar Types)

APPLICATION NOTES

The ICTE series TransZorb is characterized by the reverse stand-off voltage (V_R). It is synonymous with the integrated circuit power supply voltage. The breakdown voltage (BV) is that point at which the TransZorb is in avalanche breakdown.

This point is temperature dependent and has a positive temperature coefficient. Allowance has been made in establishing the minimum breakdown voltage at 25°C to provide safe operation over the full military temperature range.

DC LINE APPLICATIONS

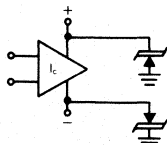

The TransZorb on the power line prevents IC failures caused by transients (electrostatic charge), power supply reversals or during switching of the power supply to on or off.

Typical power sources employing the TransZorb for Voltage Transient Protection.

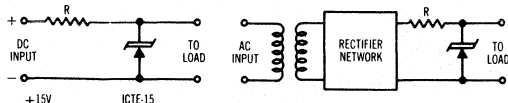

The TransZorb is chosen in which the reverse stand-off voltage is equal to or greater than the DC output voltage. For certain applications it may be more desirable to replace the series resistor (R) with an inductor. In most applications, a fuse in the line is desirable. Elimination of a transformer will require an LC filter on the line for most industrial applications, when the TransZorb is placed on the input to the power supply and with an input voltage greater than 40 volts.

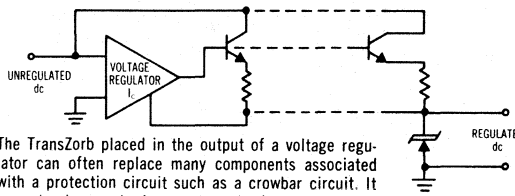

The TransZorb placed in the output of a voltage regulator can often replace many components associated with a protection circuit such as a crowbar circuit. It may also be required to protect the bypass transistor from voltage spikes across the collector to emitter terminals.

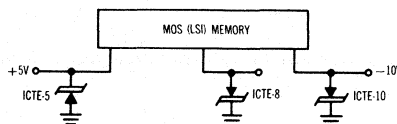

The TransZorbs protect the internal MOS FET from transients introduced on the power supply line. When interfaced with bipolar TTL circuits, the same power supply is often used. A common practice is to place a series protection diode from source to gate, but this does not offer protection from source to ground and is usually limited on peak power dissipation. A TransZorb is required on each voltage supply line to the integrated circuit.

SIGNAL LINE APPLICATION

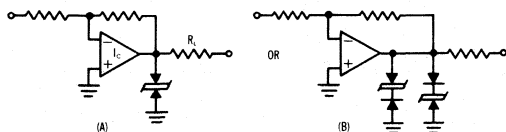

A TransZorb on the output of an Op-amp will prevent a voltage transient, due to a short circuit or an inductive load, from being transmitted into the output stage. Fig. A is for linear circuits whereas Fig. B may be required for reducing effective capacity at the output. The TransZorb and a blocking diode is available as a single unit.

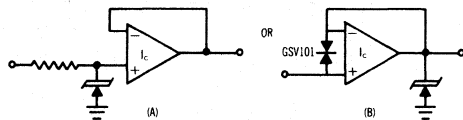

Input stages are vulnerable to low energy, high voltage static discharges or crosstalk transmitted on the signal wires. Limited protection is provided by the clamp diode or an input network within the IC substrate. The diodes, however, must have a breakdown voltage greater than the supply voltage (V_{CC}) and are limited in current capacity.

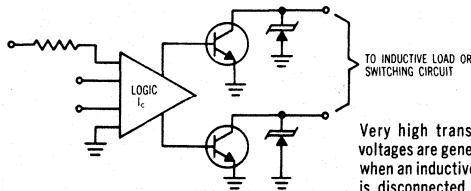

Very high transients voltages are generated when an inductive load is disconnected, such as motors, relay coils and solenoids. The TransZorb provides protection for the output transistor as well as the IC, eliminating a resistor/capacitor network.

The ICTE series TransZorb is capable of dissipating the full load current for short duration pulses (<8.3 msec). For longer pulses, the TransZorb is available in stud or press fit package.

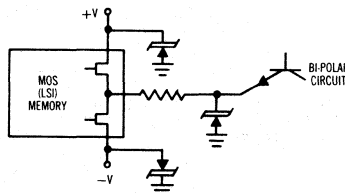

Totem pole output circuits often generate current spikes requiring decoupling capacitors. While maintaining circuit continuity, the TransZorb is capable of absorbing the

energy pulse as well as eliminating noise spikes due to such things as crosstalk, etc. A clamp diode in the IC substrate is limited in conduction current, <100 ma, providing a minimum protection. For high frequency applications a special designed TransZorb is available upon request.

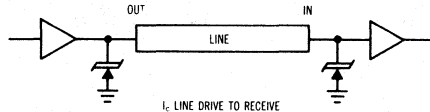

I. LINE DRIVE TO RECEIVE

Transients generated on the line can vary from a few microseconds to several milliseconds duration and up to 10,000 volts. This threat of potential energy has given rise to high noise immunity integrated circuits. An independent study* has found that high immunity and super high immunity circuits are prone to damage by noise transients as a result of the power being dissipated by the substrate input diode. Excess current passing through the input diode can cause an open circuit condition or a slow degradation of the circuit performance. TransZorbs located on the signal line can absorb this excess energy. For some circuit applications a low capacitance unit may be required, which is available upon request.

*The Radio & Electronic Engineer, Vol. 43, No. 4, April 1973

TransZorbs can be used in series or parallel to increase their power handling capability. No precautions are required when using TransZorbs in a series string since power dissipation for two or more devices of the same type is equally shared. When using TransZorbs in parallel it is necessary for the units to be closely matched (approx. .1 volt of each other) in order for equal sharing to take place. Matched sets can be ordered from the factory for an additional charge.

DIGITAL IC's

CMOS — MOS — BIPOLAR

The TransZorb type (s) listed under each integrated circuit manufacturer's series is the recommended transient voltage suppressor for power supply protection. Similar types may also be used for direct signal line protection. Special low capacitance TransZorbs for high frequency applications are available upon request.

	RCA	SSS	SOLITRON	INTEL	
CMOS	*CD4000 A (ICTE-5, -10) (ICTE-15)	SCL4000 (ICTE-5, -10) (ICTE-15)	CM 4000 (ICTE-5, -10) (ICTE-15)	5101 (ICTE-5)	
	FAIRCHILD	MOTOROLA	NATIONAL	SIGNETICS	
MOS	F-8 (ICTE-8, -15) 3100 thru 3801 (ICTE-36)	M6800 (ICTE-5) MC1120 (Series) (ICTE-36)	TI *TMS Series (ICTE-5, -12, -15, -22, -36)	*MM421/521 2650PIP (ICTE-5) IMP-4/8/16 (ICTE-5, -12)	*1101/1402 (ICTE-5, -12, -15) MCS4/40 (ICTE-15) MCS8/80 (ICTE-5, -12)
TTL	*9300 9N00 9H00	MC9300 MC5400/7400 Series (ICTE-5) MC54H00	*8000 DM54L/74L (Series) (ICTE-5) *SN54/74H DM54H00 *SN54L/74L DM54L02 *SN54S/74S	8000/MSI (ICTE-5) S5400 (ICTE-5) S54H00 (ICTE-5)	WF3000 (ICTE-5)
TT_μL	*9000 Series (ICTE-5)	MC7400	DM9002		
HTL	*9100	MC660 Series (ICTE-15)			
DTL	*9930 *9093 *930 (ICTE-5)	MC930 (ICTE-5)	SN15930 (ICTE-5)	DM930 (ICTE-5)	
ECL	9500	*MECL II MC1000-1200 Series (ICTE-5)		N1004	

*When using TransZorb devices for protection, the user should differentiate between the continuous voltage ratings and the maximum pulse voltage rating, as specified by various manufacturers. (For example see Motorola data sheet MDTLMC830, 930.) Recommended device types may have to be replaced with intermediate voltage levels as specific application for an IC varies.

LINEAR IC's

TransZorb protection for Linear IC devices will vary with each application. Specific device types are, however, listed for each IC manufacturer. The recommended TransZorb type corresponds to the power supply voltage, with the exception of the voltage regulator.

	FAIRCHILD	MOTOROLA	RCA	SIGNETICS
Operational Amplifiers	A7XX Series (ICTE-5, -12, -15, -22)	MC153X Series (ICTE-5, -12, -18)	CA3060/80 (ICTE-5, -12, -18) CA34XX Series CA37XX (ICTE-15)	SE516 (ICTE-36) LM101A (ICTE-18, -22) NE53X (ICTE-15, -22) N5556
Voltage Regulator	SH3200 (ICTE-22, -26)	MC1560/1 (ICTE-18)	CA3085 (Various ICTE types)	550 (ICTE-45)
Analog Voltage Comparator				527 (ICTE-5, -15)
Differential Amplifier		MC1519/25/26 (ICTE-12)	CA3000 (ICTE-5, -12)	A733 (ICTE-8)
Power Driver Amplifier		MC1554 (ICTE-8, -15)		540
Sense Amplifier		MC1514/40/41 (ICTE-5, -12)	CA35410 (ICTE-5, -10)	



**GENERAL
SEMICONDUCTOR
INDUSTRIES, INC.**

LOW CAPACITANCE

TRANSZORB™

LC7.5-LC200A

1

TRANSZORB8

DESCRIPTION

This specification sheet defines a series of low-capacitance silicon transient suppressors for the protection of AC signal line. This series employs a standard TransZorb in series with a rectifier with the same transient capabilities as the TransZorb. The rectifier is also used to reduce the effective capacitance up thru 100 MHz with a minimum amount of signal loss or deformation. The low-capacitance TransZorb may be applied directly across the signal line to prevent induced transients from lightning, power interruptions, or static discharge. If bipolar transient capability is required, two low-capacitance TransZorbs must be used in parallel, opposite in polarity for complete AC protection.

- 1500 watts of Peak Pulse Power dissipation at 25°C
- Available in Ranges from 6.5–200V
- Low capacitance AC signal protection

MAXIMUM RATINGS

- 1500 Watts of Peak Pulse Power dissipation at 25°C
- $t_{clamping}$ (0 volts to BV min): Less than 5×10^{-9} seconds
- Operating and Storage Temperatures: -65° to +175°C
- Steady State power dissipation: 1.0W
- Repetition Rate (duty cycle): .01%

MECHANICAL CHARACTERISTICS

- Std DO-13 package, glass and metal hermetically sealed
- Weight: 1.5 grams (approximate)
- Polarity band to be on the cathode end of the TransZorb
- Body marked with Logo and type number

ELECTRICAL CHARACTERISTICS

Clamping Factor: 1.4 @ Full Rated power
1.30 @ 50% Rated power

Clamping Factor: The ratio of the actual V_C (Clamping Voltage) to the actual BV (Breakdown Voltage) as measured on a specific device.

NOTE: When pulse testing, test in TransZorb Avalanche direction.
DO NOT pulse in forward direction.

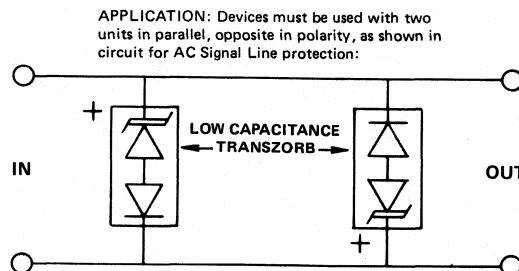
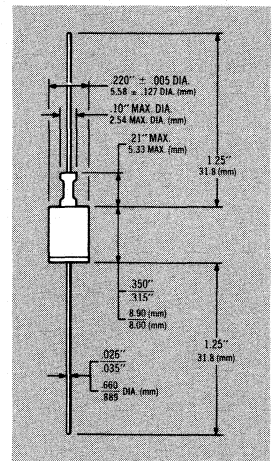
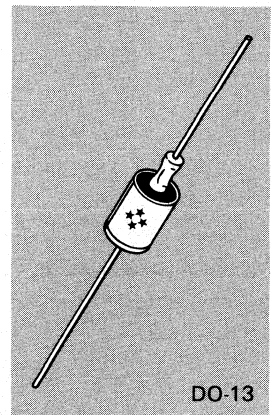

SCHEMATIC

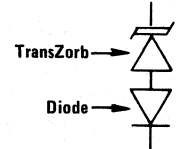

ELECTRICAL CHARACTERISTICS @ 25°C

	REVERSE STAND-OFF VOLTAGE V _R VOLTS	BREAKDOWN VOLTAGE BV Min. Max.	@ I _T mA	MAXIMUM REVERSE LEAKAGE @ V _R I _R μA	MAXIMUM CLAMPING VOLTAGE *I _{pp} V _C VOLTS	MAXIMUM PEAK PULSE CURRENT 10 x 1000	pF @ 0 VOLTS CAPACITANCE	V _{WIB} WORKING INVERSE BLOCKING VOLTAGE	I _{IB} INVERSE BLOCKING LEAKAGE CURRENT	V _{PIB} PEAK INVERSE BLOCKING VOLTAGE	
LC6.5	6.5	7.22	8.82	10	1000	12.3	100	75	1	100	
LC6.5A	6.5	7.22	7.98	10	1000	11.2	100	75	1	100	
LC7.0	7.0	7.78	9.51	10	500	13.3	100	75	1	100	
LC7.0A	7.0	7.78	8.60	10	500	12.0	100	75	1	100	
LC7.5	7.5	8.33	10.2	10	250	14.3	100	75	1	100	
LC7.5A	7.5	8.33	9.21	10	250	12.9	100	75	1	100	
LC8.0	8.0	8.89	10.9	1	100	15.0	100	75	1	100	
LC8.0A	8.0	8.89	9.83	1	100	13.6	100	75	1	100	
LC8.5	8.5	9.44	11.5	1	50	15.9	94	100	75	1	100
LC8.5A	8.5	9.44	10.4	1	50	14.4	100	75	1	100	
LC9.0	9.0	10.0	12.2	1	10	16.9	89	100	75	1	100
LC9.0A	9.0	10.0	11.1	1	10	15.4	97	100	75	1	100
LC10	10	11.1	13.6	1	5	18.8	80	100	75	1	100
LC10A	10	11.1	12.3	1	5	17.0	88	100	75	1	100
LC11	11	12.2	14.9	1	5	20.1	74	100	75	1	100
LC11A	11	12.2	13.5	1	5	18.2	82	100	75	1	100
LC12	12	13.3	16.3	1	5	22.0	68	100	75	1	100
LC12A	12	13.3	14.7	1	5	19.9	75	100	75	1	100
LC13	13	14.4	17.6	1	5	23.8	63	100	75	1	100
LC13A	13	14.4	15.9	1	5	21.5	70	100	75	1	100
LC14	14	15.6	19.1	1	5	25.8	58	100	75	1	100
LC14A	14	15.6	17.2	1	5	23.2	65	100	75	1	100
LC15	15	16.7	20.4	1	5	26.9	56	100	75	1	100
LC15A	15	16.7	18.5	1	5	24.4	61	100	75	1	100
LC16	16	17.8	21.8	1	5	28.8	52	100	75	1	100
LC16A	16	17.8	19.7	1	5	26.0	57	100	75	1	100
LC17	17	18.9	23.1	1	5	30.5	49	100	75	1	100
LC17A	17	18.9	20.9	1	5	27.6	54	100	75	1	100
LC18	18	20.0	24.4	1	5	32.2	46	100	75	1	100
LC18A	18	20.0	22.1	1	5	29.2	51	100	75	1	100
LC20	20	22.2	27.1	1	5	35.8	42	100	75	1	100
LC20A	20	22.2	24.5	1	5	32.4	46	100	75	1	100
LC22	22	24.4	29.8	1	5	39.4	38	100	75	1	100
LC22A	22	24.4	26.9	1	5	35.5	42	100	75	1	100
LC24	24	26.7	32.6	1	5	43.0	35	100	75	1	100
LC24A	24	26.7	29.5	1	5	38.9	39	100	75	1	100
LC26	26	28.9	35.3	1	5	46.6	32	100	75	1	100
LC26A	26	28.9	31.9	1	5	42.1	36	100	75	1	100
LC28	28	31.1	38.0	1	5	50.1	30	100	75	1	100
LC28A	28	31.1	34.4	1	5	45.4	33	100	75	1	100
LC30	30	33.3	40.7	1	5	53.5	28	100	75	1	100
LC30A	30	33.3	36.8	1	5	48.4	31	100	75	1	100
LC33	33	36.7	44.9	1	5	59.0	25.4	100	75	1	100
LC33A	33	36.7	40.6	1	5	53.3	28.1	100	75	1	100
LC36	36	40.0	48.9	1	5	64.3	23.3	100	75	1	100
LC36A	36	40.0	44.2	1	5	58.1	25.8	100	75	1	100
LC40	40	44.4	54.3	1	5	71.4	21.0	100	75	1	100
LC40A	40	44.4	49.1	1	5	64.5	23.3	100	75	1	100
LC43	43	47.8	58.4	1	5	76.7	19.5	100	150	1	200
LC43A	43	47.8	52.8	1	5	69.4	21.6	100	150	1	200
LC45	45	50.0	61.1	1	5	80.3	18.7	100	150	1	200
LC45A	45	50.0	55.3	1	5	72.7	20.6	100	150	1	200
LC48	48	53.3	65.1	1	5	85.5	17.5	100	150	1	200
LC48A	48	53.3	58.9	1	5	77.4	19.4	100	150	1	200
LC51	51	56.7	69.3	1	5	91.1	16.5	100	150	1	200
LC51A	51	56.7	62.7	1	5	82.4	18.2	100	150	1	200
LC54	54	60.0	73.3	1	5	96.3	15.6	100	150	1	200
LC54A	54	60.0	66.3	1	5	87.1	17.2	100	150	1	200
LC58	58	64.4	78.7	1	5	103.0	14.6	100	150	1	200
LC58A	58	64.4	71.2	1	5	93.6	16.0	100	150	1	200
LC60	60	66.7	81.5	1	5	107.0	14.0	90	150	1	200
LC60A	60	66.7	73.7	1	5	96.8	15.5	90	150	1	200
LC64	64	71.1	86.9	1	5	114.0	13.2	90	150	1	200
LC64A	64	71.1	78.6	1	5	103.0	14.6	90	150	1	200
LC70	70	77.8	95.1	1	5	125	12.0	90	150	1	200
LC70A	70	77.8	86.0	1	5	113	13.3	90	150	1	200
LC75	75	83.3	102.0	1	5	134	11.2	90	150	1	200
LC75A	75	83.3	92.1	1	5	121	12.4	90	150	1	200
LC80	80	88.7	108	1	5	142	10.6	90	150	1	200
LC80A	80	88.7	98.0	1	5	129	11.6	90	150	1	200
LC90	90	100	122	1	5	160	9.4	90	300	1	200
LC90A	90	100	111	1	5	146	10.3	90	300	1	200
LC100	100	111	136	1	5	179	8.4	90	300	1	200
LC100A	100	111	123	1	5	162	9.3	90	300	1	200
LC110	110	122	149	1	5	196	7.7	90	300	1	400
LC110A	110	122	135	1	5	178	8.4	90	300	1	400
LC120	120	133	163	1	5	214	7.0	90	300	1	400
LC120A	120	133	147	1	5	193	7.8	90	300	1	400
LC130	130	144	175	1	5	231	6.5	90	300	1	400
LC130A	130	144	159	1	5	209	7.2	90	300	1	400
LC150	150	167	204	1	5	268	5.6	90	300	1	400
LC150A	150	167	185	1	5	243	6.2	90	300	1	400
LC160	160	178	218	1	5	287	5.2	90	300	1	400
LC160A	160	178	197	1	5	259	5.8	90	300	1	400
LC170	170	189	231	1	5	304	4.9	90	300	1	400
LC170A	170	189	209	1	5	275	5.4	90	300	1	400

Note 1: A TransZorb is normally selected according to the reverse "Stand Off Voltage" (V_R) which should be equal to or greater than the DC or continuous peak operating voltage level.

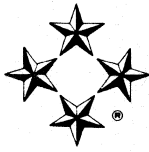

**GENERAL
SEMICONDUCTOR
INDUSTRIES, INC.**

LOW CAPACITANCE

TRANSZORB™
LCE7.5—LCE200A

1

TRANSZORBs

DESCRIPTION

This specification sheet defines a series of low-capacitance silicon transient suppressors for the protection of AC signal line. This series employs a standard TransZorb in series with a rectifier with the same transient capabilities as the TransZorb. The rectifier is also used to reduce the effective capacitance up thru 100 MHz with a minimum amount of signal loss or deformation. The low-capacitance TransZorb may be applied directly across the signal line to prevent induced transients from lightning, power interruptions, or static discharge. If bipolar transient capability is required, two low-capacitance TransZorbs must be used in parallel, opposite in polarity for complete AC protection.

- 1500 watts of Peak Pulse Power dissipation at 25°C
- Available in Ranges from 6.5—200V
- Low capacitance AC signal protection

MAXIMUM RATINGS

- 1500 Watts of Peak Pulse Power dissipation at 25°C
- $t_{clamping}$ (0 volts to BV min): Less than 5×10^{-9} seconds
- Operating and Storage temperatures: -65° to +175°C
- Steady State power dissipation. 5.0W @ $T_L = 75^\circ\text{C}$
Lead Length = 3/8"
- Repetition Rate (duty cycle): .05%

MECHANICAL CHARACTERISTICS

- Molded Case
- Polarity band to be on the cathode end of the TransZorb
- Body marked with Logo  and type number

ELECTRICAL CHARACTERISTICS

Clamping Factor: 1.4 @ Full Rated power
1.30 @ 50% Rated power

Clamping Factor: The ratio of the actual V_C (Clamping Voltage) to the actual BV (Breakdown Voltage) as measured on a specific device.

NOTE: When pulse testing, test in TransZorb Avalanche direction.
DO NOT pulse in forward direction.

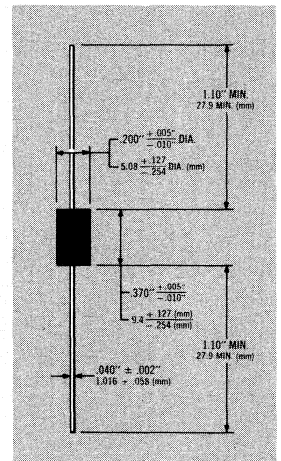
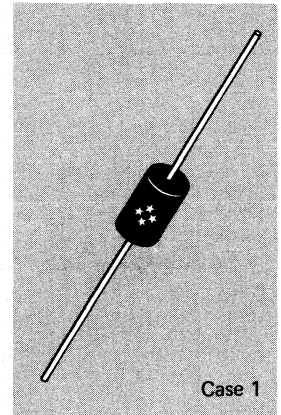

APPLICATION: Devices must be used with two units in parallel, opposite in polarity, as shown in circuit for AC Signal Line protection:

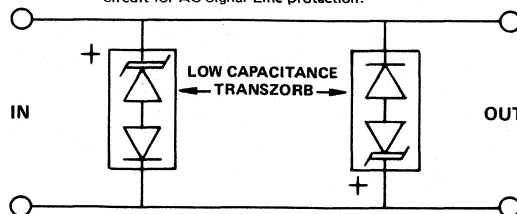

SCHEMATIC

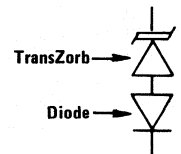

ELECTRICAL CHARACTERISTICS @ 25°C

	REVERSE STAND-OFF VOLTAGE V _R VOLTS	BREAKDOWN VOLTAGE BV Min. Max.	@ I _T mA	MAXIMUM REVERSE LEAKAGE @ V _R I _R μA	MAXIMUM CLAMPING VOLTAGE *I _{pp} V _C VOLTS	MAXIMUM PEAK PULSE CURRENT 10 x 1000	pF @ 0 VOLTS CAPACI- TANCE	V _{WR} WORKING INVERSE BLOCKING VOLTAGE	I _{IR} INVERSE BLOCKING LEAKAGE CURRENT	V _{PIR} PEAK INVERSE BLOCKING VOLTAGE	
LCE6.5	6.5	7.22	8.82	10	1000	12.3	100	75	1	100	
LCE6.5A	6.5	7.22	7.98	10	1000	11.2	100	75	1	100	
LCE7.0	7.0	7.78	9.51	10	500	13.3	100	75	1	100	
LCE7.0A	7.0	7.78	8.60	10	500	12.0	100	75	1	100	
LCE7.5	7.5	8.33	10.2	10	250	14.3	100	75	1	100	
LCE7.5A	7.5	8.33	9.21	10	250	12.9	100	75	1	100	
LCE8.0	8.0	8.89	10.9	1	100	15.0	100	75	1	100	
LCE8.0A	8.0	8.89	9.83	1	100	13.6	100	75	1	100	
LCE8.5	8.5	9.44	11.5	1	50	15.9	94	75	1	100	
LCE8.5A	8.5	9.44	10.4	1	50	14.4	100	75	1	100	
LCE9.0	9.0	10.0	12.2	1	10	16.9	89	75	1	100	
LCE9.0A	9.0	10.0	11.1	1	10	15.4	97	75	1	100	
LCE10	10	11.1	13.6	1	5	18.8	80	75	1	100	
LCE10A	10	11.1	12.3	1	5	17.0	88	75	1	100	
LCE11	11	12.2	14.9	1	5	20.1	74	75	1	100	
LCE11A	11	12.2	13.5	1	5	18.2	82	75	1	100	
LCE12	12	13.3	16.3	1	5	22.0	68	75	1	100	
LCE12A	12	13.3	14.7	1	5	19.9	75	75	1	100	
LCE13	13	14.4	17.6	1	5	23.8	63	75	1	100	
LCE13A	13	14.4	15.9	1	5	21.5	70	75	1	100	
LCE14	14	15.6	19.1	1	5	25.8	58	75	1	100	
LCE14A	14	15.6	17.2	1	5	23.2	65	75	1	100	
LCE15	15	16.7	20.4	1	5	26.9	56	75	1	100	
LCE15A	15	16.7	18.5	1	5	24.4	61	75	1	100	
LCE16	16	17.8	21.8	1	5	28.8	52	75	1	100	
LCE16A	16	17.8	19.7	1	5	26.0	57	75	1	100	
LCE17	17	18.9	23.1	1	5	30.5	49	75	1	100	
LCE17A	17	18.9	20.9	1	5	27.6	54	75	1	100	
LCE18	18	20.0	24.4	1	5	32.2	46	75	1	100	
LCE18A	18	20.0	22.1	1	5	29.2	51	75	1	100	
LCE20	20	22.2	27.1	1	5	35.8	42	75	1	100	
LCE20A	20	22.2	24.5	1	5	32.4	46	75	1	100	
LCE22	22	24.4	29.8	1	5	39.4	38	75	1	100	
LCE22A	22	24.4	26.9	1	5	35.5	42	75	1	100	
LCE24	24	26.7	32.6	1	5	43.0	35	75	1	100	
LCE24A	24	26.7	29.5	1	5	38.9	39	75	1	100	
LCE26	26	28.9	35.3	1	5	46.6	32	75	1	100	
LCE26A	26	28.9	31.9	1	5	42.1	36	75	1	100	
LCE28	28	31.1	38.0	1	5	50.1	30	75	1	100	
LCE28A	28	31.1	34.4	1	5	45.4	33	75	1	100	
LCE30	30	33.3	40.7	1	5	53.5	28	75	1	100	
LCE30A	30	33.3	36.8	1	5	48.4	31	75	1	100	
LCE33	33	36.7	44.9	1	5	59.0	25.4	75	1	100	
LCE33A	33	36.7	40.6	1	5	53.3	28.1	75	1	100	
LCE36	36	40.0	48.9	1	5	64.3	23.3	75	1	100	
LCE36A	36	40.0	44.2	1	5	58.1	25.8	75	1	100	
LCE40	40	44.4	54.3	1	5	71.4	21.0	75	1	100	
LCE40A	40	44.4	49.1	1	5	64.5	23.3	75	1	100	
LCE43	43	47.8	58.4	1	5	76.7	19.5	150	1	200	
LCE43A	43	47.8	52.8	1	5	69.4	21.6	150	1	200	
LCE45	45	50.0	61.1	1	5	80.3	18.7	150	1	200	
LCE45A	45	50.0	55.3	1	5	72.7	20.6	150	1	200	
LCE48	48	53.3	65.1	1	5	85.5	17.5	150	1	200	
LCE48A	48	53.3	58.9	1	5	77.4	19.4	150	1	200	
LCE51	51	56.7	69.3	1	5	91.1	16.5	150	1	200	
LCE51A	51	56.7	62.7	1	5	82.4	18.2	150	1	200	
LCE54	54	60.0	73.3	1	5	96.3	15.6	150	1	200	
LCE54A	54	60.0	66.3	1	5	87.1	17.2	150	1	200	
LCE58	58	64.4	78.7	1	5	103.0	14.6	150	1	200	
LCE58A	58	64.4	71.2	1	5	93.6	16.0	150	1	200	
LCE60	60	66.7	81.5	1	5	107.0	14.0	90	150	1	200
LCE60A	60	66.7	73.7	1	5	96.8	15.5	90	150	1	200
LCE64	64	71.1	86.9	1	5	114.0	13.2	90	150	1	200
LCE64A	64	71.1	78.6	1	5	103.0	14.6	90	150	1	200
LCE70	70	77.8	95.1	1	5	125	12.0	90	150	1	200
LCE70A	70	77.8	86.0	1	5	113	13.3	90	150	1	200
LCE75	75	83.3	102.0	1	5	134	11.2	90	150	1	200
LCE75A	75	83.3	92.1	1	5	121	12.4	90	150	1	200
LCE80	80	88.7	108	1	5	142	10.6	90	150	1	200
LCE80A	80	88.7	99.0	1	5	129.0	11.6	90	150	1	200
LCE90	90	100	122	1	5	160	9.4	90	300	1	200
LCE90A	90	100	111	1	5	146	10.3	90	300	1	200
LCE100	100	111	136	1	5	179	8.4	90	300	1	200
LCE100A	100	111	123	1	5	162	9.3	90	300	1	200
LCE110	110	122	149	1	5	196	7.7	90	300	1	400
LCE110A	110	122	135	1	5	178	8.4	90	300	1	400
LCE120	120	133	163	1	5	214	7.0	90	300	1	400
LCE120A	120	133	147	1	5	193	7.8	90	300	1	400
LCE130	130	144	176	1	5	231	6.5	90	300	1	400
LCE130A	130	144	159	1	5	209	7.2	90	300	1	400
LCE150	150	167	204	1	5	268	5.6	90	300	1	400
LCE150A	150	167	185	1	5	243	6.2	90	300	1	400
LCE160	160	178	218	1	5	287	5.2	90	300	1	400
LCE160A	160	178	197	1	5	259	5.8	90	300	1	400
LCE170	170	189	231	1	5	304	4.9	90	300	1	400
LCE170A	170	189	209	1	5	275	5.4	90	300	1	400

Note 1: A TransZorb is normally selected according to the reverse "Stand Off Voltage" (V_R) which should be equal to or greater than the DC or continuous peak operating voltage level.



**GENERAL
SEMICONDUCTOR
INDUSTRIES, INC.**

TRANSZORB
TRANSIENT VOLTAGE
SUPPRESSORS
MPT-5
THRU
MPT-45C

1
TRANSZORBs

DESCRIPTION

. . . a premium transient voltage suppressor specifically designed and tested to protect Bipolar and MOS microprocessor based systems from electrical disturbances. Transients and noise pulses are generated by electromechanical switching, electromagnetic coupling, capacitive or inductive load switching, voltage reversals, and electrostatic discharge. The TransZorb is desired over and above a crowbar circuit, an LC or RC network, and a catch or clamping diode because of fewer components, speed of response, high power or energy absorption and low clamping ratio.

- Transient protection for CMOS, MOS, and BIPOLAR MICROPROCESSORS
- Voltage range of 5.0 to 45 volts
- Low clamping ratio

MAXIMUM RATINGS

- 1500 Watts of Peak Pulse Power dissipation at 25°C
- $t_{clamping}$ (0 volts to BV min): Unipolar — Less than 1×10^{-12} seconds
Bidirectional — Less than 5×10^{-9} seconds
- Operating and Storage temperatures: - 65° to +175°C
- Forward surge rating: 200 amps, 1/120 second at 25°C
(Applies to Unipolar or single direction only)
- Steady State power dissipation: 1.0 watt
- Repetition rate (duty cycle): .01%

MECHANICAL CHARACTERISTICS

- Standard DO-13 package, glass and metal hermetically sealed
- Weight. 1.5 grams (approximate)
- Positive terminal marked with band (except Bidirectional types)
- Body marked with Logo *** and type number

ELECTRICAL CHARACTERISTICS

- Clamping Factor: 1.33 @ Full rated power
1.20 @ 50% rated power

Clamping Factor: The ratio of the actual V_C (Clamping Voltage) to the actual BV (Breakdown Voltage) as measured on a specific device.
(See Figure 2, Page 1-1 for Test Pulse Wave Shape.)

- Peak Pulse Power vs Pulse Time. Figure 1, Page 1-1
- Power Wave Form. Figure 2, Page 1-1
- Power-Temperature Derating Curve. Figure 3, Page 1-1
- Capacitor Discharge Test Circuit Figure 4, Page 1-2

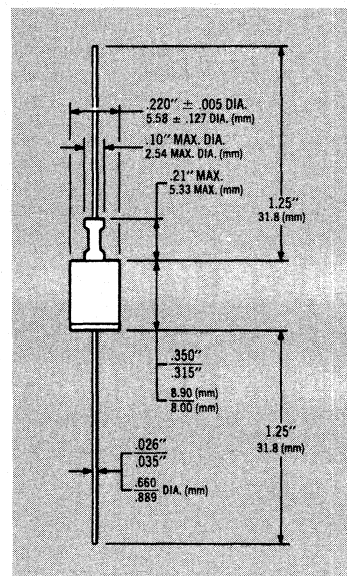
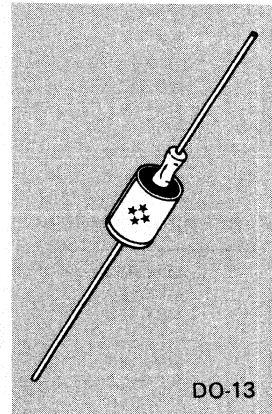

ELECTRICAL CHARACTERISTICS @ 25°C

GENERAL SEMICONDUCTOR PART NUMBER	STAND-OFF VOLTAGE (Note 1) V_R VOLTS	MAXIMUM REVERSE LEAKAGE @ V_R I_R μA	MINIMUM* BREAKDOWN VOLTAGE @ 1 mA BV(min) VOLTS	MAXIMUM CLAMPING VOLTAGE (Fig. 2) @ $I_{PP1} = 1A$ V_C VOLTS	MAXIMUM CLAMPING VOLTAGE (Fig. 2) @ $I_{PP2} = 10A$ V_C VOLTS	MAXIMUM PEAK PULSE CURRENT I_{PP3} A
MPT-5	5.0	300	6.0	7.1	7.5	160
MPT-8	8.0	25	9.4	11.3	11.5	100
MPT-10	10.0	2	11.7	13.7	14.1	90
MPT-12	12.0	2	14.1	16.1	16.5	70
MPT-15	15.0	2	17.6	20.1	20.6	60
MPT-18	18.0	2	21.2	24.2	25.2	50
MPT-22	22.0	2	25.9	29.8	32.0	40
MPT-36	36.0	2	42.4	50.6	54.3	23
MPT-45	45.0	2	52.9	63.3	70.0	19

V_f at 100 amps peak, 8.3 msec sine wave equals 3.5 volts maximum

ELECTRICAL CHARACTERISTICS @ 25°C (Test Both Polarities)

MPT-8C	8.0	25	9.4	11.4	11.6	100
MPT-10C	10.0	2	11.7	14.1	14.5	90
MPT-12C	12.0	2	14.1	16.7	17.1	70
MPT-15C	15.0	2	17.6	20.8	21.4	60
MPT-18C	18.0	2	21.2	24.8	25.5	50
MPT-22C	22.0	2	25.9	30.8	32.0	40
MPT-36C	36.0	2	42.4	50.6	54.3	23
MPT-45C	45.0	2	52.9	63.3	70.0	19

C Suffix indicates Bipolar

MPT-5 not available as Bipolar

Note 1: A TransZorb is normally selected according to the reverse "Stand Off Voltage" (V_R) which should be equal to or greater than the DC or continuous peak operating voltage level.

*The minimum breakdown voltage as shown takes into consideration the ± 1 volt tolerance normally specified for power supply regulation on most integrated circuit manufacturers data sheets. Similar TransZorb devices are available with reduced clamping voltages where tighter regulated power supply voltages are employed.

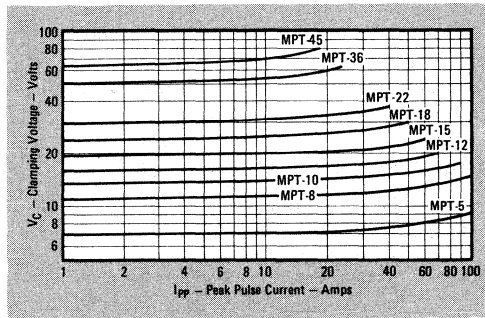

Typical Characteristic Clamping Voltage vs Peak Pulse Current

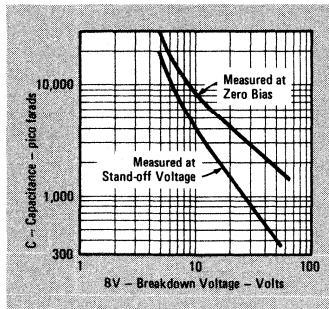

Typical Capacitance vs Breakdown Voltage (Unipolar Types)

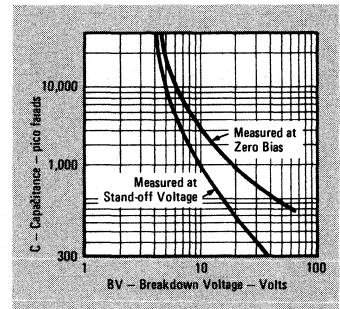

Typical Capacitance vs Breakdown Voltage (Bipolar Types)

APPLICATION NOTES

The μP -series TransZorb is characterized by the reverse stand-off voltage (V_R). It is synonymous with the integrated circuit power supply voltage. The breakdown voltage (BV) is that point at which the TransZorb is in avalanche breakdown.

This point is temperature dependent and has a positive temperature coefficient. Allowance has been made in establishing the minimum breakdown voltage at 25°C to provide safe operation over the full military temperature range.

MICROPROCESSOR SYSTEM APPLICATIONS

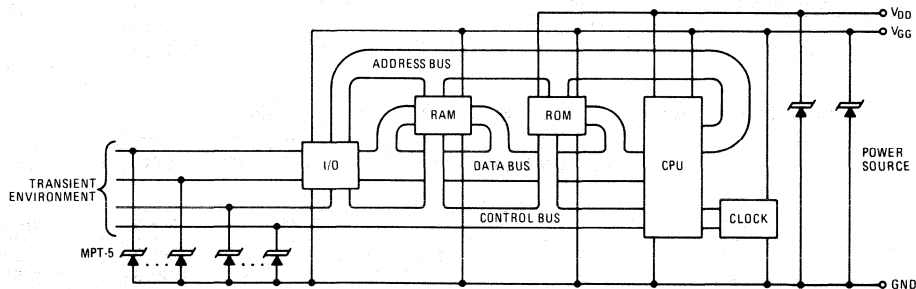

The TransZorb on the signal and input power lines prevent microprocessor system failures caused by transients (electrostatic charges), AC power surges, or during switching of the power supply to ON or OFF. A static discharge can exceed 10,000V for 10 microseconds with a 60 Amp current potential. 10V applied to a typical T²L circuit for 30

nanoseconds will cause destruction. Placing TransZorbs across the signal lines to ground will keep unwanted transients out of the Data and Control Buses. TransZorbs which are shunted across the power lines maintain a continuous operating voltage during AC line surges and switching transients.

PERIPHERAL APPLICATIONS

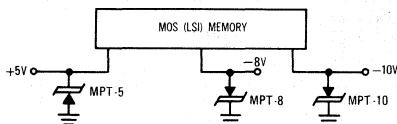

The TransZorbs protect the internal MOS FET from transients introduced on the power supply line. When interfaced with bipolar TTL circuits, the same power supply is often used. A common practice is to place a series protection diode from source to gate, but this does not offer protection from source to ground and is usually limited on peak power dissipation. A TransZorb is required on each voltage supply line to the integrated circuit.

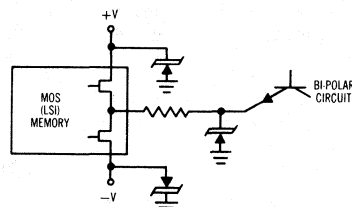

energy pulse as well as eliminating noise spikes due to such things as crosstalk, etc. A clamp diode in the IC substrate is limited in conduction current, <100 ma, providing a minimum protection. For high frequency applications a special designed TransZorb is available upon request.

Totem pole output circuits often generate current spikes requiring decoupling capacitors. While maintaining circuit continuity, the TransZorb is capable of absorbing the

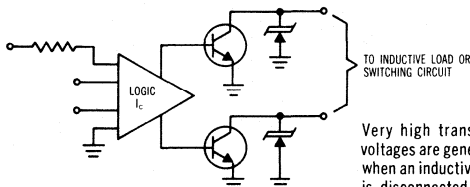

Very high transients are generated when an inductive load is disconnected, such as

motors, relay coils and solenoids. The TransZorb provides protection for the output transistor as well as the IC, eliminating a resistor/capacitor network. The μP -series TransZorb is capable of dissipating the full load current for short duration pulses (<8.3 msec). For longer pulses, the TransZorb is available in stud or press fit package.

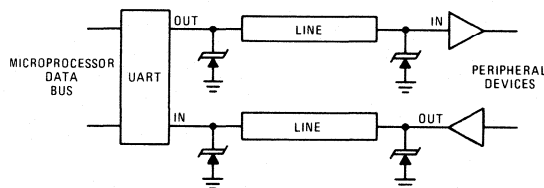

Transients generated on the line can vary from a few microseconds to several milliseconds duration and up to 10,000 volts. This threat of potential energy has given rise to high noise immunity integrated circuits. An independent study* has found that high immunity and super high immunity circuits are prone to damage by noise transients as a result of the power being dissipated by the substrate input diode. Excess current passing through the input diode can cause an open circuit condition or a slow degradation of the circuit performance. TransZorbs located on the signal line can absorb this excess energy. For some circuit applications a low capacitance unit may be required, which is available upon request.

Typical power sources employing the TransZorb for Voltage Transient Protection.

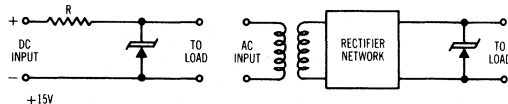

The TransZorb is chosen in which the reverse stand-off voltage is equal to or greater than the DC output voltage. For certain applications it may be more desirable to replace the series resistor (R.) with an inductor. In most applications, a fuse in the line is desirable. Elimination of a transformer will require an LC filter on the line for most industrial applications, when the TransZorb is placed on the input to the power supply and with an input voltage greater than 40 volts.

*The Radio & Electronic Engineer, Vol. 43, No. 4, April 1973

TransZorbs can be used in series or parallel to increase their power handling capability. No precautions are required when using TransZorbs in a series string since power dissipation for two or more devices of the same type is equally shared. When using TransZorbs in parallel it is necessary for the units to be closely matched (approx. .1 volt of each other) in order for equal sharing to take place. Matched sets can be ordered from the factory for an additional charge.

PRODUCT GUIDE

MICROPROCESSORS

The recommended TransZorb (s) listed under the manufacturers type is one which has been selected to provide optimum protection for his microprocessor. Similar types may also be used for direct signal line protection. Special low capacitance TransZorbs for high frequency applications are available upon request. JAN and JANTX devices are also available.

	FAIRCHILD	MOTOROLA	G.I.	SIGNETICS	W.D.C.	INTEL	
NMOS	F-8 (MPT-8,-15)	MC6800 (MPT-5)	CP-1600 (MPT-5,-12)	2650 PIP (MPT-5)	MPS-1600 (MPT-5,-12)	8080 8008 (MPT-5,-12)	
	ROCKWELL	MOSTEK	NATIONAL	INTERSIL	RCA	NEC	INTEL
MOS	PPS-4 PPS-8 (MPT-18)	MK5065 (MPT-5,-12)	IMP-4/8/16 (MPT-5,-12)	1M 6100 (MPT-5,-12)	COSMAC (MPT-5,-12)	μPD753 (MPT-5,-12)	4040 4004 (MPT-15)
	MONOLITHIC MEMORIES		SCIENTIFIC MICRO SYSTEMS		S.S.S.	INTEL	
TTL	5701 6701 (MPT-5)		MicroController (MPT-5)		CRD-8 (MPT-5)	3000 (MPT-5)	

MEMORIES

	MOTOROLA	FAIRCHILD	SIGNETICS	T.I.	INTEL	AMI
ROM						
MOS	MCM14524 (MPT-18)		2530 2580 (MPT-5,-12)		1702 (MPT-5,-10)	S8772 (MPT-5,-12)
TTL	MCM4064 (MPT-5)	93434 (MPT-5)	7488 8204 (MPT-5)	SN74186 ZN74187 (MPT-5)	3601 (MPT-5)	
RAM						
MOS	MCM14505 (MPT-18)		2501 2602 (MPT-5,-9)		2107B (MPT-5,-12)	S2103 (MPT-15,-18)
TTL	MC4304 (MPT-5)	93400 (MPT-5)	7489 82S06 (MPT-5)	SN74S200 (MPT-5)		



**GENERAL
SEMICONDUCTOR
INDUSTRIES, INC.**

TRANSZORBSM
TRANSIENT VOLTAGE
SUPPRESSORS
MPTE-5
THRU
MPTE-45C

1
TRANSZORBSM

DESCRIPTION

... a premium transient voltage suppressor specifically designed and tested to protect Bipolar and MOS microprocessor based systems from electrical disturbances. Transients and noise pulses are generated by electromechanical switching, electromagnetic coupling, capacitive or inductive load switching, voltage reversals, and electrostatic discharge. The TransZorb is desired over and above a crowbar circuit, an LC or RC network and a catch or clamping diode because of fewer components, speed of response, high power or energy absorption and low clamping ratio.

- Transient protection for CMOS, MOS, and BIPOLAR MICROPROCESSORS
- Voltage range of 5.0 to 45 volts
- Low clamping ratio

MAXIMUM RATINGS

- 1500 Watts of Peak Pulse Power dissipation at 25°C
- $t_{clamping}$ (0 volts to BV min): Unipolar – Less than 1×10^{-12} seconds
Bidirectional – Less than 5×10^{-9} seconds
- Operating and Storage temperatures: – 65° to +175°C
- Forward surge rating: 200 amps, 1/120 second at 25°C
(Applies to Unipolar or single direction only)
- Steady State power dissipation: 5.0 watts @ $T_L = 75^\circ C$, Lead Length = 3/8"
- Repetition rate (duty cycle): .05%

MECHANICAL CHARACTERISTICS

- Molded case
- Weight. 1.5 grams (approximate)
- Positive terminal marked with band (except Bidirectional types)
- Body marked with Logo  and type number

ELECTRICAL CHARACTERISTICS

- Clamping Factor: 1.33 @ Full rated power
1.20 @ 50% rated power

Clamping Factor: The ratio of the actual V_C (Clamping Voltage) to the actual BV (Breakdown Voltage) as measured on a specific device.
(See Figure 2, Page 1-1 for Test Pulse Wave Shape.)

- Peak Pulse Power vs Pulse Time. Figure 1, Page 1-1
- Pulse Wave Form. Figure 2, Page 1-1
- Power-Temperature Derating Curve. Figure 3, Page 1-1
- Capacitor Discharge Test Circuit. Figure 4, Page 1-2

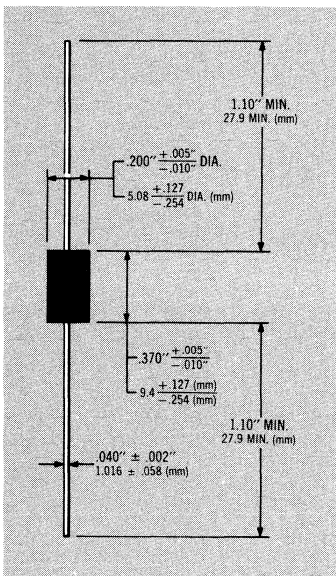
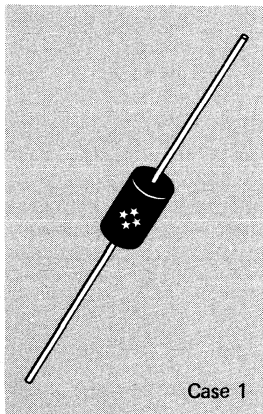

ELECTRICAL CHARACTERISTICS @ 25°C

GENERAL SEMICONDUCTOR PART NUMBER	STAND-OFF VOLTAGE (Note 1) V_R VOLTS	MAXIMUM REVERSE LEAKAGE @ V_R I_R μA	MINIMUM* BREAKDOWN VOLTAGE @ 1 mA BV(min) VOLTS	MAXIMUM CLAMPING VOLTAGE (Fig. 2) @ $I_{PP1} = 1A$ V_C VOLTS	MAXIMUM CLAMPING VOLTAGE (Fig. 2) @ $I_{PP2} = 10A$ V_C VOLTS	MAXIMUM PEAK PULSE CURRENT I_{PP3} A
MPTE-5	5.0	300	6.0	7.1	7.5	160
MPTE-8	8.0	25	9.4	11.3	11.5	100
MPTE-10	10.0	2	11.7	13.7	14.1	90
MPTE-12	12.0	2	14.1	16.1	16.5	70
MPTE-15	15.0	2	17.6	20.1	20.6	60
MPTE-18	18.0	2	21.2	24.2	25.2	50
MPTE-22	22.0	2	25.9	29.8	32.0	40
MPTE-36	36.0	2	42.4	50.6	54.3	23
MPTE-45	45.0	2	52.9	63.3	70.0	19

V_f at 100 amps peak, 8.3 msec sine wave equals 3.5 volts maximum

ELECTRICAL CHARACTERISTICS @ 25°C (Test Both Polarities)

MPTE-8C	8.0	25	9.4	11.4	11.6	100
MPTE-10C	10.0	2	11.7	14.1	14.5	90
MPTE-12C	12.0	2	14.1	16.7	17.1	70
MPTE-15C	15.0	2	17.6	20.8	21.4	60
MPTE-18C	18.0	2	21.2	24.8	25.5	50
MPTE-22C	22.0	2	25.9	30.8	32.0	40
MPTE-36C	36.0	2	42.4	50.6	54.3	23
MPTE-45C	45.0	2	52.9	63.3	70.0	19

C Suffix indicates Bipolar

MPTE-5 not available as Bipolar

Note 1: A TransZorb is normally selected according to the reverse "Stand Off Voltage" (V_R) which should be equal to or greater than the DC or continuous peak operating voltage level.

*The minimum breakdown voltage as shown takes into consideration the ± 1 volt tolerance normally specified for power supply regulation on most integrated circuit manufacturers data sheets. Similar TransZorb devices are available with reduced clamping voltages where tighter regulated power supply voltages are employed.

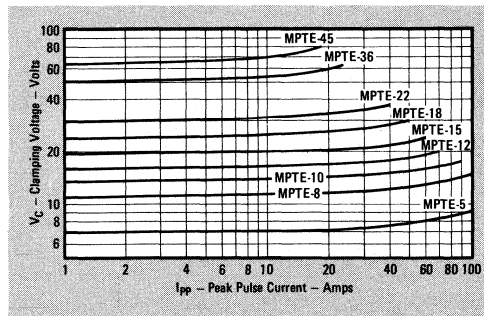

Typical Characteristic Clamping Voltage vs Peak Pulse Current

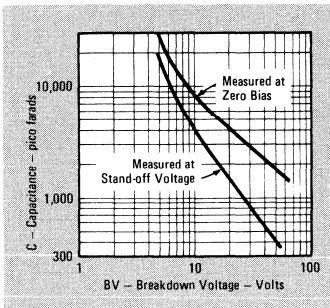

Typical Capacitance vs Breakdown Voltage (Unipolar Types)

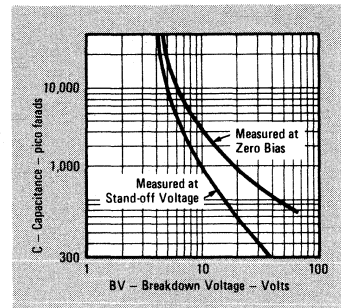

Typical Capacitance vs Breakdown Voltage (Bipolar Types)

The μ P-series TransZorb is characterized by the reverse stand-off voltage (V_R). It is synonymous with the integrated circuit power supply voltage. The breakdown voltage (BV) is that point at which the TransZorb is in avalanche breakdown.

This point is temperature dependent and has a positive temperature coefficient. Allowance has been made in establishing the minimum breakdown voltage at 25°C to provide safe operation over the full military temperature range.

MICROPROCESSOR SYSTEM APPLICATIONS

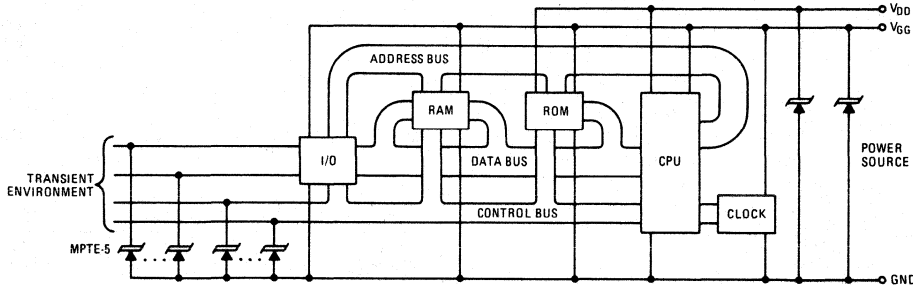

The TransZorb on the signal and input power lines prevent microprocessor system failures caused by transients (electrostatic charges), AC power surges, or during switching of the power supply to ON or OFF. A static discharge can exceed 10,000V for 10 microseconds with a 60 Amp current potential. 10V applied to a typical T²L circuit for 30

nanoseconds will cause destruction. Placing TransZorbs across the signal lines to ground will keep unwanted transients out of the Data and Control Buses. TransZorbs which are shunted across the power lines maintain a continuous operating voltage during AC line surges and switching transients.

PERIPHERAL APPLICATIONS

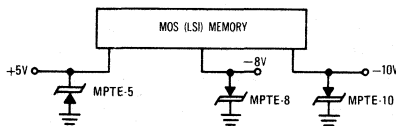

The TransZorbs protect the internal MOS FET from transients introduced on the power supply line. When interfaced with bipolar TTL circuits, the same power supply is often used. A common practice is to place a series protection diode from source to gate, but this does not offer protection from source to ground and is usually limited on peak power dissipation. A TransZorb is required on each voltage supply line to the integrated circuit.

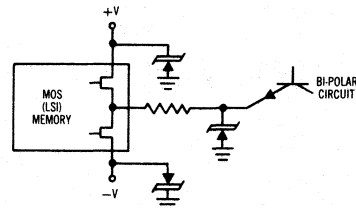

Totem pole output circuits often generate current spikes requiring decoupling capacitors. While maintaining circuit continuity, the TransZorb is capable of absorbing the

energy pulse as well as eliminating noise spikes due to such things as crosstalk, etc. A clamp diode in the IC substrate is limited in conduction current, <100 ma, providing a minimum protection. For high frequency applications a special designed TransZorb is available upon request.

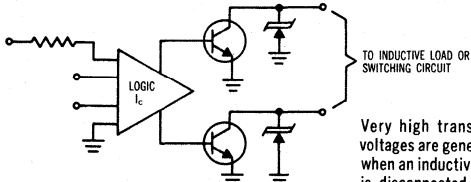

Very high transients are generated when an inductive load is disconnected, such

as motors, relay coils and solenoids. The TransZorb provides protection for the output transistor as well as the IC, eliminating a resistor/capacitor network. The μ P-series TransZorb is capable of dissipating the full load current for short duration pulses (<8.3 msec). For longer pulses, the TransZorb is available in stud or press fit package.

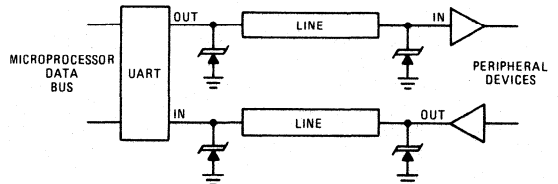

Transients generated on the line can vary from a few microseconds to several milliseconds duration and up to 10,000 volts. This thread of potential energy has given rise to high noise immunity integrated circuits. An independent study* has found that high immunity and super high immunity circuits are prone to damage by noise transients as a result of the power being dissipated by the substrate input diode. Excess current passing through the input diode can cause an open circuit condition or a slow degradation of the circuit performance. TransZorbs located on the signal line can absorb this excess energy. For some circuit applications a low capacitance unit may be required, which is available upon request.

Typical power sources employing the TransZorb for Voltage Transient Protection.

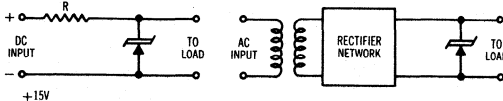

The TransZorb is chosen in which the reverse stand-off voltage is equal to or greater than the DC output voltage. For certain applications it may be more desirable to replace the series resistor (R.) with an inductor. In most applications, a fuse in the line is desirable. Elimination of a transformer will require an LC filter on the line for most industrial applications, when the TransZorb is placed on the input to the power supply and with an input voltage greater than 40 volts.

*The Radio & Electronic Engineer, Vol. 43, No. 4, April 1973

TransZorbs can be used in series or parallel to increase their power handling capability. No precautions are required when using TransZorbs in a series string since power dissipation for two or more devices of the same type is equally shared. When using TransZorbs in parallel it is necessary for the units to be closely matched (approx. .1 volt of each other) in order for equal sharing to take place. Matched sets can be ordered from the factory for an additional charge.

PRODUCT GUIDE

MICROPROCESSORS

The recommended TransZorb (s) listed under the manufacturers type is one which has been selected to provide optimum protection for his microprocessor. Similar types may also be used for direct signal line protection. Special low capacitance TransZorbs for high frequency applications are available upon request. JAN and JANTX devices are also available.

	FAIRCHILD	MOTOROLA	G.I.	SIGNETICS	W.D.C.	INTEL	
NMOS	F-8 (MPTE-8,-15)	MC6800 (MPTE-5)	CP-1600 (MPTE-5,-12)	2650 PIP (MPTE-5)	MPS-1600 (MPTE-5,-12)	8080 8008 (MPTE-5,-12)	
	ROCKWELL	MOSTEK	NATIONAL	INTERSIL	RCA	NEC	INTEL
MOS	PPS-4 PPS-8 (MPTE-18)	MK5065 (MPTE-5,-12)	IMP-4/8/16 (MPTE-5,-12)	1M 6100 (MPTE-5,-12)	COSMAC (MPTE-5,-12)	μPD753 (MPTE-5,-12)	4040 4004 (MPTE-15)
	MONOLITHIC MEMORIES		SCIENTIFIC MICRO SYSTEMS		S.S.S.	INTEL	
TTL	5701 6701 (MPTE-5)			MicroController (MPTE-5)	CRD-8 (MPTE-5)	3000 (MPTE-5)	

MEMORIES

ROM	MOTOROLA	FAIRCHILD	SIGNETICS	T.I.	INTEL	AMI
MOS	MCM14524 (MPTE-18)		2530 2580 (MPTE-5,-12)		1702 (MPTE-5,-10)	S8772 (MPTE-5,-12)
TTL	MCM4064 (MPTE-5)	93434 (MPTE-5)	7488 8204 (MPTE-5)	SN74186 ZN74187 (MPTE-5)	3601 (MPTE-5)	
RAM	MOTOROLA	FAIRCHILD	SIGNETICS	T.I.	INTEL	AMI
MOS	MCM14505 (MPTE-18)		2501 2602 (MPTE-5,-9)		2107B (MPTE-5,-12)	S2103 (MPTE-15,-18)
TTL	MC4304 (MPTE-5)	93400 (MPTE-5)	7489 82S06 (MPTE-5)	SN74S200 (MPTE-5)		



**GENERAL
SEMICONDUCTOR
INDUSTRIES, INC.**

TRANSZORB[®]
TRANSIENT VOLTAGE
SUPPRESSORS
P6KE6.8
THRU
P6KE200A

1
TRANSZORB[®]

DESCRIPTION

... a low cost commercial product for use in applications where large voltage transients can permanently damage voltage sensitive components.

This TransZorb has a peak pulse power rating of 600 watts for one millisecond. The response time of TransZorb clamping action is theoretically instantaneous (1×10^{-12} sec); therefore, they can protect integrated Circuits, MOS devices, Hybrids, and other voltage-sensitive semiconductors and components. TransZorbs can also be used in series or parallel to increase the peak power ratings.

- 600 watts peak power dissipation
- Available in ranges from 6.8V to 200V

MAXIMUM RATINGS

- 600 Watts of Peak Pulse Power dissipation at 25°C (see derating curve)
- $t_{clamping}$ (0 volts to BV min): Less than 1×10^{-12} seconds
- Operating and Storage temperatures: -65° to +175°C
- Forward surge rating: 100 amps, 1/120 second at 25°C
- Steady State power dissipation: 5.0 watts $T_L = 75^\circ C$, Lead Length = 3/8"
- Repetition rate (duty cycle): .01%

MECHANICAL CHARACTERISTICS

- Molded case
- Weight: 1.5 grams (approximate)
- Positive terminal marked with band
- Body marked with Logo and type number

DEVICES FOR BIPOLAR APPLICATIONS

For Bidirectional use C or CA Suffix for types P6KE7.5 through types P6KE200. Electrical characteristics apply in both directions. The maximum reverse leakage current must be doubled for voltage types up to 11 volts for bipolar devices.

- Pulse Wave Form Figure 2, Page 1-1
- Power-Temperature Derating Curve. Figure 3, Page 1-1
- Capacitor Discharge Test Circuit Figure 4, Page 1-2

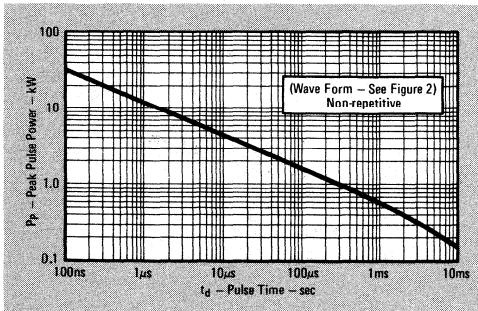
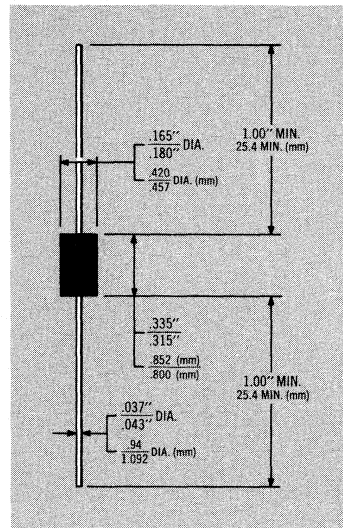
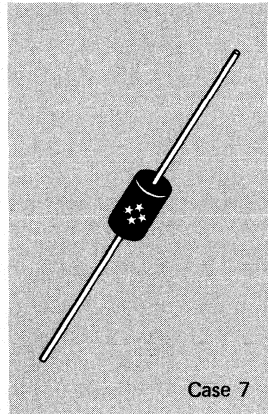

Peak Pulse Power vs Pulse Time

ELECTRICAL CHARACTERISTICS @ 25°C

GENERAL SEMICONDUCTOR PART NUMBER	REVERSE STAND-OFF VOLTAGE (Note 1) V _R VOLTS	BREAKDOWN VOLTAGE @		I _T mA	MAXIMUM CLAMPING VOLTAGE @ I _{PP} (1 msec) V _C VOLTS	MAXIMUM REVERSE LEAKAGE @ V _R I _R ↑ μA	MAXIMUM PEAK PULSE CURRENT (Fig. 2) I _{PP} A	MAXIMUM TEMPERATURE COEFFICIENT OF BV %/°C
		BV VOLTS	V _R mA					
* P6KE6.8	5.50	6.12 - 7.48	10	10.8	1000	56	.057	
* P6KE6.8A	5.80	6.45 - 7.14	10	10.5	1000	57	.057	
P6KE7.5	6.05	6.75 - 8.25	10	11.7	500	51	.061	
P6KE7.5A	6.40	7.13 - 7.88	10	11.3	500	53	.061	
P6KE8.2	6.63	7.38 - 9.02	10	12.5	200	48	.065	
P6KE8.2A	7.02	7.79 - 8.61	10	12.1	200	50	.065	
P6KE9.1	7.37	8.10 - 10.0	1	13.8	50	44	.068	
P6KE9.1A	7.78	8.65 - 9.55	1	13.4	50	45	.068	
P6KE10	8.10	9.00 - 11.0	1	15.0	10	40	.073	
P6KE10A	8.55	9.5 - 10.5	1	14.5	10	41	.073	
P6KE11	8.92	9.9 - 12.1	1	16.2	5	37	.075	
P6KE11A	9.40	10.5 - 11.6	1	15.6	5	38	.075	
P6KE12	9.72	10.8 - 13.2	1	17.3	5	35	.078	
P6KE12A	10.2	11.4 - 12.6	1	16.7	5	36	.078	
P6KE13	10.5	11.7 - 14.3	1	19.0	5	32	.081	
P6KE13A	11.1	12.4 - 13.7	1	18.2	5	33	.081	
P6KE15	12.1	13.5 - 16.5	1	22.0	5	27	.084	
P6KE15A	12.8	14.3 - 15.8	1	21.2	5	28	.084	
P6KE16	12.9	14.4 - 17.6	1	23.5	5	26	.086	
P6KE16A	13.6	15.2 - 16.8	1	22.5	5	27	.086	
P6KE18	14.5	16.2 - 19.8	1	26.5	5	23	.088	
P6KE18A	15.3	17.1 - 18.9	1	25.2	5	24	.088	
P6KE20	16.2	18.0 - 22.0	1	29.1	5	21	.090	
P6KE20A	17.1	19.0 - 21.0	1	27.7	5	22	.090	
P6KE22	17.8	19.8 - 24.2	1	31.9	5	19	.092	
P6KE22A	18.8	20.9 - 23.1	1	30.6	5	20	.092	
P6KE24	19.4	21.6 - 26.4	1	34.7	5	17	.094	
P6KE24A	20.5	22.8 - 25.2	1	33.2	5	18	.094	
P6KE27	21.8	24.3 - 29.7	1	39.1	5	15	.096	
P6KE27A	23.1	25.7 - 28.4	1	37.5	5	16	.096	
P6KE30	24.3	27.0 - 33.0	1	43.5	5	14	.097	
P6KE30A	25.6	28.5 - 31.5	1	41.4	5	14.4	.097	
P6KE33	26.8	29.7 - 36.3	1	47.7	5	12.6	.098	
P6KE33A	28.2	31.4 - 34.7	1	45.7	5	13.2	.098	
P6KE36	29.1	32.4 - 39.6	1	52.0	5	11.6	.099	
P6KE36A	30.8	34.2 - 37.8	1	49.9	5	12.0	.099	
P6KE39	31.6	35.1 - 42.9	1	56.4	5	10.6	.100	
P6KE39A	33.3	37.1 - 41.0	1	53.9	5	11.2	.100	
P6KE43	34.8	38.7 - 47.3	1	61.9	5	9.6	.101	
P6KE43A	36.8	40.9 - 45.2	1	59.3	5	10.1	.101	
P6KE47	38.1	42.3 - 51.7	1	67.8	5	8.9	.101	
P6KE47A	40.2	44.7 - 49.4	1	64.8	5	9.3	.101	
P6KE51	41.3	45.9 - 56.1	1	73.5	5	8.2	.102	
P6KE51A	43.6	48.5 - 53.6	1	70.1	5	8.6	.102	
P6KE56	45.4	50.4 - 61.6	1	80.5	5	7.4	.103	
P6KE56A	47.8	53.2 - 58.8	1	77.0	5	7.8	.103	
P6KE62	50.2	55.8 - 68.2	1	89.0	5	6.8	.104	
P6KE62A	53.0	58.9 - 65.1	1	85.0	5	7.1	.104	
P6KE68	55.1	61.2 - 74.8	1	98.0	5	6.1	.104	
P6KE68A	58.1	64.6 - 71.4	1	92.0	5	6.5	.104	
P6KE75	60.7	67.5 - 82.5	1	108.0	5	5.5	.105	
P6KE75A	64.1	71.3 - 78.8	1	103.0	5	5.8	.105	
P6KE82	66.4	73.8 - 90.2	1	118.0	5	5.1	.105	
P6KE82A	70.1	77.9 - 86.1	1	113.0	5	5.3	.105	
P6KE91	73.7	81.9 - 100.0	1	131.0	5	4.5	.106	
P6KE91A	77.8	86.5 - 95.5	1	125.0	5	4.8	.106	
P6KE100	81.0	90.0 - 110.0	1	144.0	5	4.2	.106	
P6KE100A	85.5	95.0 - 105.0	1	137.0	5	4.4	.106	
P6KE110	89.2	99.0 - 121.0	1	158.0	5	3.8	.107	
P6KE110A	94.0	105.0 - 116.0	1	152.0	5	4.0	.107	
P6KE120	97.2	108.0 - 132.0	1	173.0	5	3.5	.107	
P6KE120A	102.0	114.0 - 126.0	1	165.0	5	3.6	.107	
P6KE130	105.0	117.0 - 143.0	1	187.0	5	3.2	.107	
P6KE130A	111.0	124.0 - 137.0	1	179.0	5	3.3	.107	
P6KE150	121.0	135.0 - 165.0	1	215.0	5	2.8	.108	
P6KE150A	128.0	143.0 - 158.0	1	207.0	5	2.9	.108	
P6KE160	130.0	144.0 - 176.0	1	230.0	5	2.6	.108	
P6KE160A	136.0	152.0 - 168.0	1	219.0	5	2.7	.108	
P6KE170	138.0	153.0 - 187.0	1	244.0	5	2.5	.108	
P6KE170A	145.0	162.0 - 179.0	1	234.0	5	2.6	.108	
P6KE180	146.0	162.0 - 198.0	1	258.0	5	2.3	.108	
P6KE180A	154.0	171.0 - 189.0	1	246.0	5	2.4	.108	
P6KE200	162.0	180.0 - 220.0	1	287.0	5	2.1	.108	
P6KE200A	171.0	190.0 - 210.0	1	274.0	5	2.2	.108	

V_f at 50 amps peak, 8.3 msec sine wave equals 3.5 volts maximum *Note: Not available as bidirectional

Note 1: A TransZorb is normally selected according to the reverse "Stand Off Voltage" (V_R) which should be equal to or greater than the DC or continuous peak operating voltage level.

† For bipolar types P6KE7.5C thru P6KE11C, I_R MAX must be double that specified for single polarity types.



**GENERAL
SEMICONDUCTOR
INDUSTRIES, INC.**

**BIDIRECTIONAL
TRANSZORB[®]
TRANSIENT VOLTAGE
SUPPRESSORS
PIP8.4
THRU
PIP500**

1

TRANSZORBS

DESCRIPTION

This series is designed for industrial applications for across the line AC protection. i.e., supervisory control systems, CATV, telecommunications, and computers. These units have been tested under laboratory and actual systems environments and found to provide excellent protection.

TransZorbs are Silicon PN Junction devices designed to absorb high voltage transients associated with induced lightning effects and voltage disturbances. This series is available from 8.4 volts through 500 volts. Special voltages are available from the factory.

- High power module 7.5 & 15KW
- Designed for CATV systems
- Type designates RMS voltages
- UL Recognized ( PIP120)

MAXIMUM RATINGS

- 15,000 watts Peak Pulse Power dissipation at the 1 msec pulse and 25°C: See Derating Curve and Peak Power Ratings
- Steady State power dissipation at 50°C: 10 watts
(15 watts – PIP8.4, 24,30)
- Operating and Storage Temperatures: -65° to +150° C
- $t_{clamping}$ (0 volts to BV): Less than 1×10^{-8} seconds

MECHANICAL CHARACTERISTICS

- Molded Case
- Bidirectional
- Body marked with Logo  and type number

- Pulse Wave Form Figure 2, Page 1-1
- Power-Temperature Derating Curve Figure 3, Page 1-1
- Capacitor Discharge Test Circuit Figure 4, Page 1-2

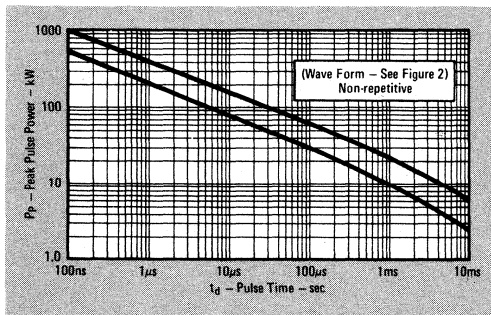
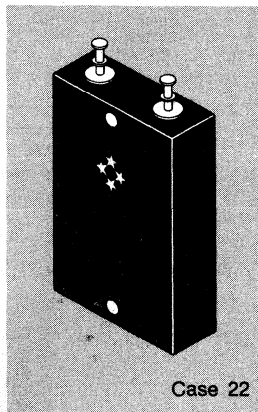

Peak Pulse Power vs Pulse Time

ELECTRICAL CHARACTERISTICS @ 25°C (Test Both Polarities)

General Semiconductor Part Number	Average RMS Voltage Volts AC	Stand-Off Voltage (V _R) (Note 1) Volts DC	Maximum Reverse Leakage (I _R) @ V _R Micro Amperes	Minimum Breakdown Voltage @ (I _T)		Maximum Clamping Voltage (V _C) @ I _{pp} Volts DC	Peak Pulse Current (Fig. 2) (I _{pp}) Amperes	Maximum Peak Pulse Power (1 msec) (P _p) Kilowatts
				(BV)	mA			
PIP8.4	8.4	12.0	250	14	10	22	341	7.5
PIP24	24.0	34.0	250	40	10	67	112	7.5
PIP30	30.0	42.5	250	50	1.0	84	90	7.5
PIP60	60.0	85.0	250	100	1.0	167	90	15.0
PIP120*	120.0	170.0	250	200	1.0	319	47	15.0
PIP208	208.0	295.0	250	347	1.0	536	28	15.0
PIP250*	250.0	354.0	250	418	1.0	652	23	15.0
PIP440	440.0	623.0	250	735	1.0	1138	13.2	15.0
PIP500*	500.0	708.0	250	835	1.0	1292	11.6	15.0

Note 1: A TransZorb is normally selected according to the reverse "Stand Off Voltage" (V_R) which should be equal to or greater than the DC or continuous peak operating voltage level.

Note 2: Military grade product available. Contact Factory.

*Note 3: Recommended for marine applications.

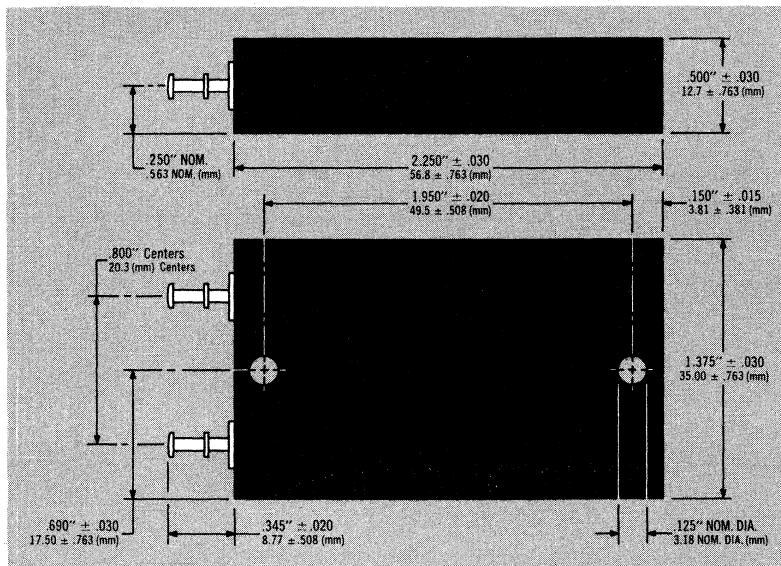

APPLICATION NOTE

The typical application is for the TransZorb device to be placed across the secondary of the transformer or after a filter circuit on the AC power source and before the Cable System Power Supply. In areas of high energy transient activity, a more complete protection can be attained by using a network consisting of an arrestor, resistor and TransZorb combination across the power supply primary.

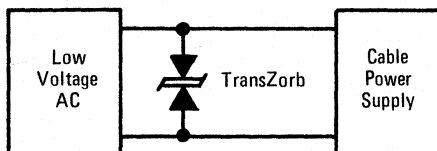



**GENERAL
SEMICONDUCTOR
INDUSTRIES, INC.**

**TRANSZORB
500 WATTS
SA1001
THRU
SA1037A**

1

TRANSZORB88

DESCRIPTION

This TransZorb series is a low-cost commercial and industrial product for use in applications where large voltage transients can permanently damage voltage-sensitive components.

TransZorbs are characterized by their high-surge capability, extremely fast response time, and low impedance, (R_{ON}). Because of the unpredictable nature of transients and the variation of the impedance with respect to these transients, impedance, per se, is not specified as a parametric value. However, a minimum voltage at low-current conditions (V_B) and a maximum clamping voltage (V_C) at a maximum peak pulse current is specified. In addition, a maximum clamping ratio is indicated. In some instances, the thermal effect (see V_C Clamping Voltage) may be responsible for 50% to 70% of the observed voltage differential when subjected to high-current pulses or severe duty cycles, thus making a maximum impedance specification insignificant. Curves depicting clamping voltage vs. various current pulses are available from the factory. Extended power curves vs. pulse time are also available.

This TransZorb has a peak pulse power rating of 500 watts for one millisecond. The response time of TransZorb clamping action is theoretically instantaneous (1×10^{-12} sec); therefore, they can protect integrated Circuits, MOS devices, Hybrids, and other voltage-sensitive semiconductors and components. TransZorbs can also be used in series or parallel to increase the peak power ratings. This is only one of many series of Transient Voltage Suppressors available from General Semiconductor Industries.

- Available in ranges from 6.8V to 200V.
- Small package size DO-41

MAXIMUM RATINGS

- 500 Watts of Peak Pulse Power dissipation at 25°C (see derating curve)
- $t_{clamping}$ (0 volts to V_B min): Less than 1×10^{-12} seconds (theoretical)
- Operating and Storage temperatures: -65° to +175°C
- Forward surge rating: 70 amps, 1/120 second at 25°C
- Steady State power dissipation: 2.0 watts $T_L = 75^\circ C$, Lead Length = 3/8"
- Repetition rate (duty cycle): .01%

MECHANICAL CHARACTERISTICS

- Molded Case
- Weight: 1 gram (approximate)
- Positive terminal marked with band
- Body marked with Logo and type number

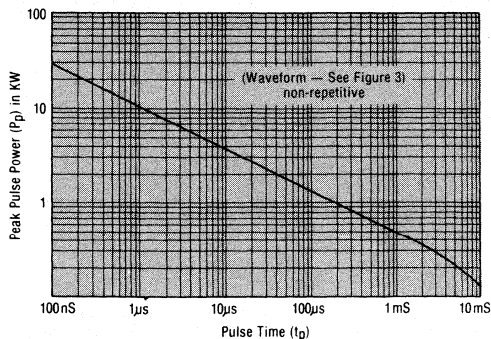
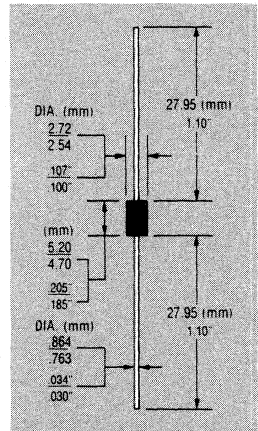
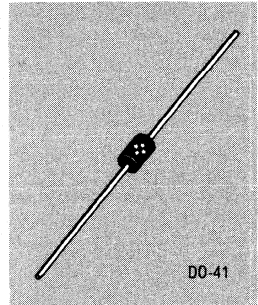

FIGURE 1
Peak Pulse Power vs Pulse Time

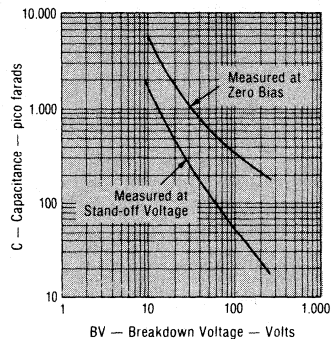

FIGURE 2
Typical Capacitance vs Breakdown Voltage

ELECTRICAL CHARACTERISTICS AT 25°C

GS TYPE NO.	REVERSE STAND-OFF VOLTAGE	BREAKDOWN VOLTAGE		MAXIMUM CLAMPING VOLTAGE @ I _{pp}	MAXIMUM REVERSE LEAKAGE @ V _R	MAXIMUM PEAK PULSE CURRENT	MAXIMUM COEFF. OF BV
	(Note 1) V _R VOLTS	BV	VOLTS @ I _T mA	(Fig. 2) V _C VOLTS	(Note 2) I _R μA	(Fig. 2) I _{pp} A	%/°C
SA1001	5.50	6.12 - 7.48	10	10.8	1000	46.3	.057
SA1001A	5.80	6.45 - 7.14	10	10.5	1000	47.6	.057
SA1002	6.05	6.75 - 8.25	10	11.7	500	42.7	.061
SA1002A	6.40	7.13 - 7.88	10	11.3	500	44.2	.061
SA1003	6.63	7.38 - 9.02	10	12.5	200	40.0	.065
SA1003A	7.02	7.79 - 8.61	10	12.1	200	41.3	.065
SA1004	7.37	8.19 - 10.0	1	13.8	50	36.2	.068
SA1004A	7.78	8.65 - 9.55	1	13.4	50	37.3	.068
SA1005	8.10	9.00 - 11.0	1	15.0	10	33.3	.073
SA1005A	8.65	9.5 - 10.5	1	14.5	10	34.5	.073
SA1006	8.92	9.9 - 12.1	1	16.2	5	30.9	.075
SA1006A	9.40	10.5 - 11.6	1	15.6	5	32.0	.075
SA1007	9.72	10.8 - 13.2	1	17.3	5	28.3	.078
SA1007A	10.2	11.4 - 12.6	1	16.7	5	29.9	.078
SA1008	10.5	11.7 - 14.3	1	19.0	5	26.3	.081
SA1008A	11.1	12.4 - 13.7	1	18.2	5	27.5	.081
SA1009	12.1	13.5 - 16.5	1	22.0	5	22.7	.084
SA1009A	12.8	14.3 - 15.8	1	21.2	5	23.6	.084
SA1010	12.9	14.4 - 17.6	1	23.5	5	21.3	.086
SA1010A	13.6	15.2 - 16.8	1	22.5	5	22.2	.086
SA1011	14.5	16.2 - 19.8	1	26.5	5	18.9	.088
SA1011A	15.3	17.1 - 19.9	1	25.2	5	19.8	.088
SA1012	16.2	18.0 - 22.0	1	29.1	5	17.2	.090
SA1012A	17.1	19.0 - 21.0	1	27.7	5	18.0	.090
SA1013	17.8	19.8 - 24.2	1	31.9	5	15.7	.092
SA1013A	18.8	20.9 - 23.1	1	30.9	5	16.3	.092
SA1014	19.4	21.6 - 26.4	1	34.7	5	14.4	.094
SA1014A	20.5	22.8 - 25.2	1	33.2	5	15.1	.094
SA1015	21.9	24.3 - 29.7	1	39.1	5	12.8	.096
SA1015A	23.1	25.7 - 28.4	1	37.5	5	13.3	.096
SA1016	24.3	27.0 - 33.0	1	43.5	5	11.5	.097
SA1016A	25.6	28.5 - 31.5	1	41.4	5	12.1	.097
SA1017	26.8	29.7 - 36.3	1	47.7	5	10.5	.098
SA1017A	28.2	31.4 - 34.7	1	45.7	5	10.9	.098
SA1018	29.1	32.4 - 39.6	1	52.0	5	9.6	.099
SA1018A	30.8	34.2 - 37.8	1	49.9	5	10.0	.099
SA1019	31.6	35.1 - 42.9	1	56.4	5	8.9	.100
SA1019A	33.3	37.1 - 41.0	1	53.9	5	9.3	.100
SA1020	34.8	38.7 - 47.3	1	61.9	5	8.1	.101
SA1020A	36.8	40.9 - 45.2	1	59.3	5	8.4	.101
SA1021	38.1	42.3 - 51.7	1	67.8	5	7.4	.101
SA1021A	40.2	44.7 - 49.4	1	64.8	5	7.7	.101
SA1022	41.3	45.9 - 56.1	1	73.5	5	6.8	.102
SA1022A	43.6	48.5 - 53.8	1	70.1	5	7.1	.102
SA1023	45.4	50.4 - 61.6	1	80.5	5	6.2	.103
SA1023A	47.8	53.2 - 58.8	1	77.0	5	6.5	.103
SA1024	50.2	55.8 - 68.2	1	89.0	5	5.6	.104
SA1024A	53.0	58.9 - 65.1	1	85.0	5	5.9	.104
SA1025	55.1	61.2 - 74.8	1	98.0	5	5.1	.104
SA1025A	58.1	64.6 - 71.4	1	92.0	5	5.4	.104
SA1026	60.7	67.5 - 82.5	1	108.0	5	4.8	.105
SA1026A	64.1	71.3 - 78.8	1	103.0	5	4.8	.105
SA1027	66.4	73.8 - 90.2	1	118.0	5	4.2	.105
SA1027A	70.1	77.9 - 86.1	1	113.0	5	4.4	.105
SA1028	73.7	81.9 - 100.0	1	131.0	5	3.8	.106
SA1028A	77.8	86.5 - 95.5	1	125.0	5	4.0	.106
SA1029	81.0	90.0 - 110.0	1	144.0	5	3.5	.106
SA1029A	95.5	95.0 - 105.0	1	137.0	5	3.6	.106
SA1030	99.2	99.0 - 121.0	1	158.0	5	3.2	.107
SA1030A	104.0	105.0 - 116.0	1	152.0	5	3.3	.107
SA1031	97.2	108.0 - 132.0	1	173.0	5	2.9	.107
SA1031A	102.0	114.0 - 126.0	1	165.0	5	3.0	.107
SA1032	105.0	117.0 - 143.0	1	187.0	5	2.7	.107
SA1032A	111.0	124.0 - 137.0	1	179.0	5	2.8	.107
SA1033	121.0	135.0 - 165.0	1	215.0	5	2.3	.108
SA1033A	128.0	143.0 - 158.0	1	207.0	5	2.4	.108
SA1034	130.0	144.0 - 176.0	1	230.0	5	2.2	.108
SA1034A	136.0	152.0 - 168.0	1	219.0	5	2.3	.108
SA1035	138.0	153.0 - 187.0	1	244.0	5	2.0	.108
SA1035A	145.0	162.0 - 179.0	1	234.0	5	2.1	.108
SA1036	146.0	162.0 - 198.0	1	258.0	5	1.9	.108
SA1036A	154.0	171.0 - 189.0	1	246.0	5	2.0	.108
SA1037	162.0	180.0 - 220.0	1	287.0	5	1.7	.108
SA1037A	171.0	190.0 - 210.0	1	274.0	5	1.8	.108

V_R at 35 AMPS PEAK, 8.3 MSEC SINE WAVE equals 3.5 VOLTS MAXIMUM.

Note 1: A TransZorb is normally selected according to the reverse "Stand Off Voltage" (V_R) which should be equal to or greater than the DC or continuous peak operating voltage level.

Note 2: For Bipolar types 10 volts and under, the I_R limit is doubled.

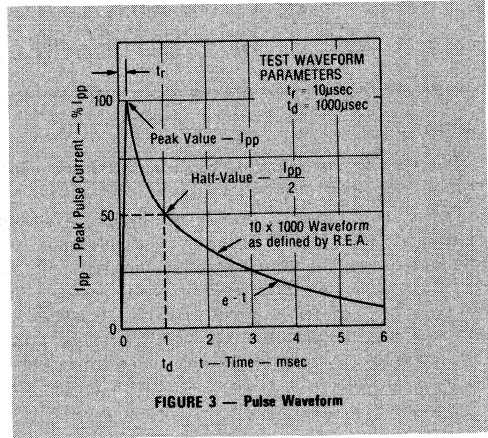
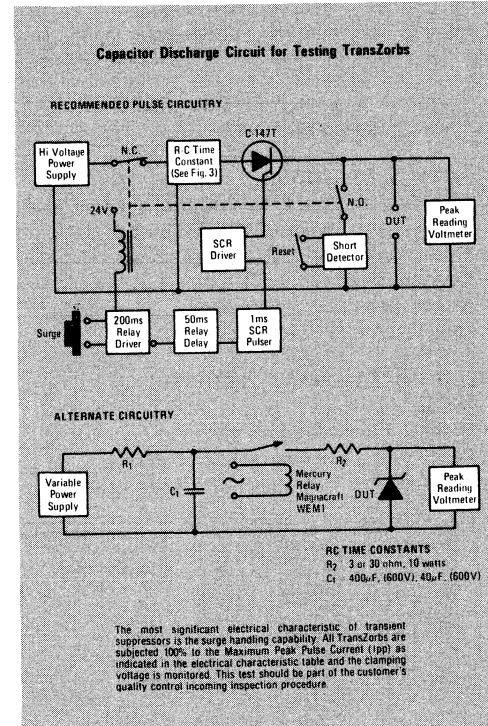

FIGURE 3 — Pulse Waveform



The most significant electrical characteristic of transient suppressors is the surge handling capability. All TransZorbs are subjected 100% to the Maximum Peak Pulse Current (I_{pp}) as indicated in the electrical characteristic table and the clamping voltage is monitored. This test should be part of the customer's quality control incoming inspection procedure.

BIPOLAR APPLICATIONS

For Bipolar use C or CA Suffix for types SA1002 through types SA1037A. Electrical characteristics apply in both directions. For 10 volts and under double the reverse leakage current.



GENERAL
SEMICONDUCTOR
INDUSTRIES, INC.

BIDIRECTIONAL
VARISTOR
GSV
SERIES

1

VARISTORS

DESCRIPTION

These varistors consist of two matched silicon junctions connected in parallel and opposite in polarity. They are designed to replace copper oxide varistors in telephone equipment and for numerous applications ranging from fractional voltage regulators, negative temperature coefficient resistors, signal limiters and expanders and meter protection. The GSV varistors are packaged in a plastic encapsulated material. Higher voltage devices are also available from the factory.

MAXIMUM RATINGS

- Steady State Power: 1.0 watt at 50°C
- Operating and Storage Temperature: -65° to +175°C
- Surge: 30 Amps, 8.4 msec @ 25°C
70 Amps, 1.0 msec @ 25°C
- $t_{clamping}$ (0 volts to BV min.): Less than 1×10^{-8} seconds

MECHANICAL CHARACTERISTICS

- Molded Case
- Bidirectional
- Body marked with Logo  and type number

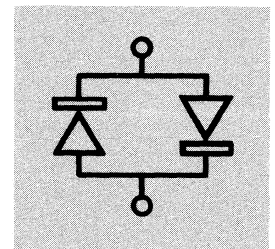
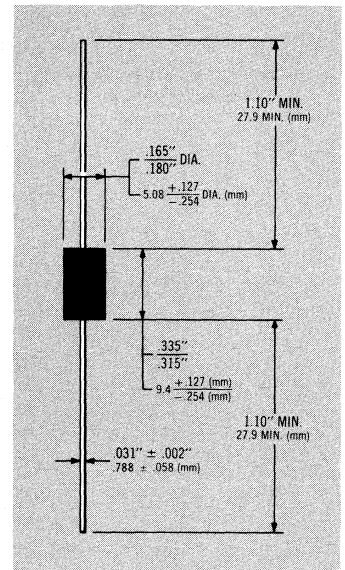
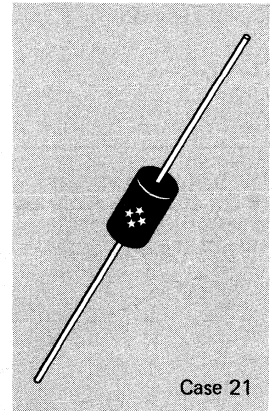

ELECTRICAL CHARACTERISTICS @ 25°C (Test Both Polarities)

GENERAL SEMICONDUCTOR PART NUMBER	SYMBOL	CONDITIONS	LIMITS		UNITS
			Min.	Max.	
GSV101	V_F	10.0 μA	.35	.50	Vdc
	V_F	100.0 mA	.74	.85	Vdc
GSV102	V_F	100.0 mA	.74	.85	Vdc
	I_F	0.2 V		.10	μA
GSV103	V_F	1.0 μA	.30	.45	Vdc
	V_F	10.0 μA	.40	.50	Vdc
	V_F	100.0 μA	.48	.58	Vdc
	V_F	1.0 mA	.56	.66	Vdc
	V_F	10.0 mA	.65	.74	Vdc
	V_F	100.0 mA	.75	.82	Vdc

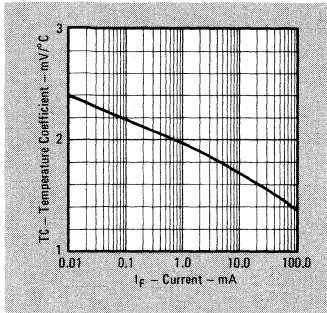

Ambient Temperature Coefficient of Voltage vs Varistor Current

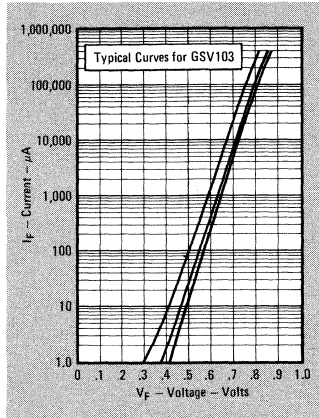

Range Curve Current-Voltage for GSV Varistor



GENERAL
SEMICONDUCTOR
INDUSTRIES, INC.

BIDIRECTIONAL
SURGE
SUPPRESSORS
GHV-2
THRU
GHV-16

1
LOW VOLTAGE
SURGE SUPPRESSORS

DESCRIPTION

The GHV Series devices are silicon transient voltage suppressors designed for protection against large voltage transients on signal lines. They are low capacitance, low noise devices which can be used directly across the input of analog and digital circuitry with minimum signal loss. Noise is typically 30db below zero.

Their small size and high surge current capability make them ideal suppressors for telephone and CATV repeaters, replacing typical varistor series "strings" which consume much needed space. The device has been proven effective in lightning environments.

MAXIMUM RATINGS

- Surge: 30 amps, 8.4 msec
100 amps, 1.0 msec.
(capacitance, decay to 50%)
- Operating and Storage Temperature: -65° to $+150^{\circ}$ C
- t_{clamping} (0 volts to BV min.): Less than 1×10^{-8} seconds
- Steady State Power: 1 watt at 50° C

MECHANICAL CHARACTERISTICS

- Molded Case
- Bidirectional
- Body marked with Logo  and type number

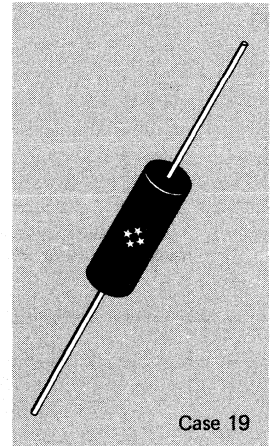

Case 19

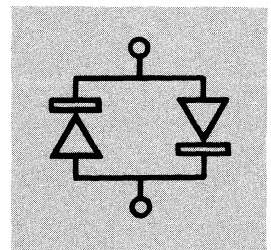
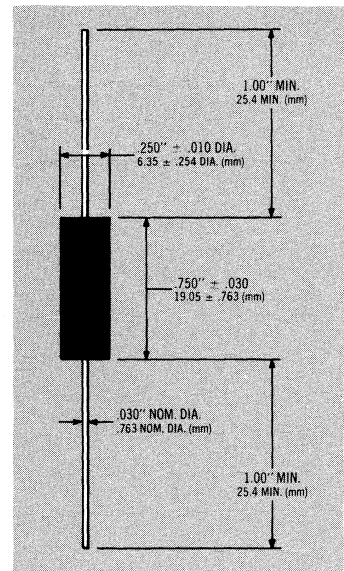

ELECTRICAL CHARACTERISTICS @ 25°C (Test Both Polarities)

GENERAL SEMICONDUCTOR PART NUMBER	BREAKDOWN VOLTAGE @ 10 mA BV ± 5% VOLTS	STAND-OFF VOLTAGE (Note 1) VR VOLTS	MAXIMUM LEAKAGE CURRENT @ VR μA	MAXIMUM CAPACITANCE @ 0 V, 1 MHz pf	TYPICAL TEMPERATURE COEFFICIENT OF BV mV/°C
GHV-2	1.33	.8	10	517	-4
GHV-3	2.0	1.2	10	319	-6
GHV-4	2.7	1.6	10	259	-8
GHV-5	3.3	2.0	10	191	-10
GHV-6	4.0	2.4	10	159	-12
GHV-7	4.7	2.8	10	140	-14
GHV-8	5.4	3.2	10	130	-16
GHV-9	6.0	3.6	10	114	-18
GHV-10	6.7	4.0	10	102	-20
GHV-11	7.3	4.4	10	93	-22
GHV-12	8.0	4.8	10	86	-24
GHV-13	8.7	5.2	10	79	-26
GHV-14	9.4	5.6	10	74	-28
GHV-15	10.0	6.0	10	67	-30
GHV-16	10.7	6.4	10	62	-32

*Note 1: A voltage suppressor is normally selected according to the reverse "Stand Off Voltage" (VR) which should be equal to or greater than the DC or continuous peak operating voltage level.

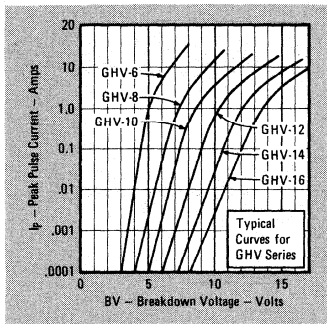

Voltage Current Characteristic Curves

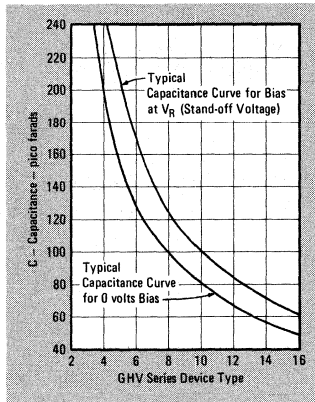

Typical Capacitance Curves for GHV Series Surge Suppressors

1 WATT, Metal (Case DO-13)

JEDEC TYPE NUMBER†	NOMINAL ZENER VOLTAGE Vz VOLTS	TEST CURRENT IZT mA	MAXIMUM ZENER IMPEDANCE ZT @ IZT Ohms	MAXIMUM DC ZENER CURRENT IZM mA
1N1507	3.9	35	15	180
1N1508	4.7	30	13	150
1N1509	5.6	26	11	130
1N1510	6.8	22	3.0	110
1N1511	8.2	18	3.0	90
1N1512	10	15	3.2	75
1N1513	12	12	6.5	60
1N1514	15	18	10.5	50
1N1515	18	8	16	40
1N1516	22	6	40	33
1N1517	27	5	82	26
1N1518	3.9	50	10	250
1N1519	4.7	40	13	200
1N1520	5.6	35	10.2	175
1N1521	6.8	30	4.2	150
1N1522	8.2	25	3	120
1N1523	10	20	4	100
1N1524	12	15	6	80
1N1525	15	13	13	65
1N1526	18	10	25	55
1N1527	22	9	32	45
1N1528	27	7	45	35

†Non Suffix Vz = ±10%

Standard Polarity -- Cathode to Case

A Suffix Vz = ±5%

1 WATT, Metal (Case DO-13)

JEDEC TYPE NUMBER†	NOMINAL ZENER VOLTAGE Vz VOLTS	TEST CURRENT IZT mA	MAXIMUM ZENER IMPEDANCE ZT @ IZT Ohms	MAXIMUM DC ZENER CURRENT IZM mA
1N1765	5.6	100	1.2	162
1N1766	6.2	100	1.5	147
1N1767	6.8	100	1.7	134
1N1768	7.5	100	2.1	121
1N1769	8.2	100	2.4	111
1N1770	9.1	50	3.0	100
1N1771	10	50	3.5	91
1N1772	11	50	4.2	83
1N1773	12	50	5.0	76
1N1774	13	50	5.8	70
1N1775	15	50	7.6	61
1N1776	16	50	8.6	57
1N1777	18	50	11	50
1N1778	20	15	13	45
1N1779	22	15	16	41
1N1780	24	15	18	38
1N1781	27	15	23	34
1N1782	30	15	28	30
1N1783	33	15	33	27.5
1N1784	36	15	39	25.2
1N1785	39	15	45	23.3
1N1786	43	15	54	21.2
1N1787	47	15	64	19.3
1N1788	51	15	74	17.8
1N1789	56	15	88	16.2
1N1790	62	5	105	14.7
1N1791	68	5	105	13.4
1N1792	75	5	125	12.1
1N1793	82	5	175	11.1
1N1794	91	5	220	10.0
1N1795	100	5	260	9.1
1N1796	110	5	320	8.3
1N1797	120	5	390	7.6
1N1798	130	5	450	7.0
1N1799	150	5	600	6.1
1N1800	160	5	700	5.7
1N1801	180	5	900	5.0
1N1802	200	5	1100	4.5

†Non Suffix Vz = ±10%

Standard Polarity -- Cathode to Case

A Suffix Vz = ±5%

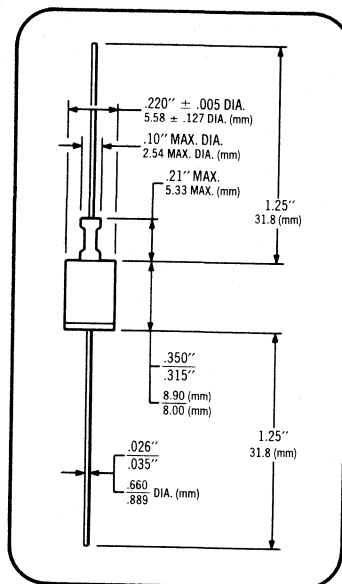
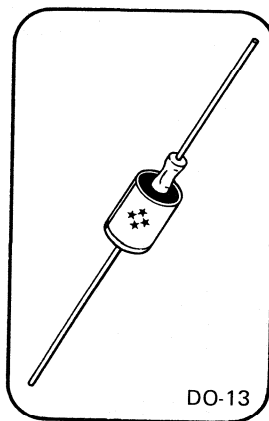

1 WATT, Metal (Case DO-13)

JEDEC TYPE NUMBER †	NOMINAL ZENER VOLTAGE V_Z VOLTS	TEST CURRENT I_{ZT} mA	MAXIMUM ZENER IMPEDANCE Z_{ZT} @ I_{ZT} Ohms	MAXIMUM REVERSE LEAKAGE CURRENT I_R @ V_R @ 25°C	
				μA	VOLTS
1N1875	8.2	25	5.0	20	4.5
1N1876	10.0	25	6.0	20	6
1N1877	12.0	25	7.0	20	8
1N1878	15.0	25	8.0	20	10
1N1879	18.0	25	9.0	20	12
1N1880	22.0	8	24.0	20	15
1N1881	27.0	8	27.0	10	18
1N1882	33.0	8	30.0	10	21
1N1883	39.0	8	35.0	10	25
1N1884	47.0	8	50.0	10	35
1N1885	56.0	8	75.0	10	40
1N1886	68.0	3	250.0	10	50
1N1887	82.0	3	325.0	10	60
1N1888	100.0	3	400.0	10	70
1N1889	120.0	3	350.0	10	80
1N1890	145.0	3	700.0	10	90

†Non Suffix $V_Z = \pm 10\%$

A Suffix $V_Z = \pm 5\%$

Standard Polarity – Cathode to Case

1 WATT, Metal (Case DO-13)

JEDEC TYPE NUMBER	ZENER VOLTAGE V_Z VOLTS			TEST CURRENT I_{ZT} mA	MAXIMUM ZENER IMPEDANCE Z_{ZT} @ I_{ZT} Ohms
	Min.	Nom. ($\pm 5\%$)	Max.		
1N2032	4.3		5.4	10	55
1N2032-1		4.5		10	55
1N2032-2		5.0		10	55
1N2033	5.2		6.4	10	20
1N2033-1		5.5		10	20
1N2033-2		6.0		10	20
1N2034	6.2		8.0	10	8
1N2034-1		6.5		10	8
1N2034-2		7.0		10	8
1N2034-3		7.5		10	8
1N2035	7.5		10.0	10	15
1N2035-1		8.0		10	15
1N2035-2		8.5		10	15
1N2035-3		9.0		10	15
1N2035-4		9.5		10	15
1N2036	9.0		12.0	5	50
1N2036-1		10.0		5	50
1N2036-2		11.0		5	50
1N2037	11.0		14.5	5	70
1N2037-1		12.0		5	70
1N2037-2		13.0		5	70
1N2037-3		14.0		5	70
1N2038	13.5		18.0	5	120
1N2038-1		15.0		5	120
1N2038-2		16.0		5	120
1N2038-3		17.0		5	120
1N2039	17.0		21.0	5	200
1N2039-1		18.0		5	200
1N2039-2		19.0		5	200
1N2039-3		20.0		5	200
1N2040	20.0		27.0	5	300
1N2040-1		22.0		5	300
1N2040-2		24.0		5	300
1N2040-3		26.0		5	300

Standard Polarity – Cathode to Case

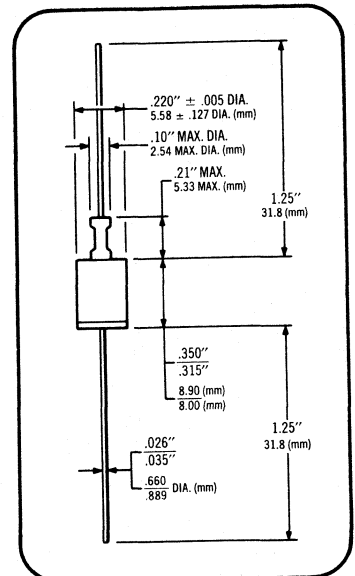
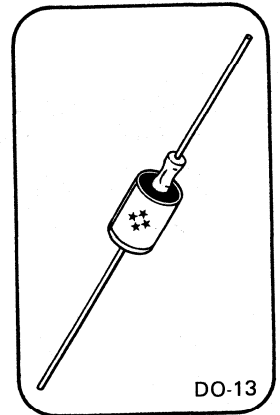

1 WATT, Metal (Case DO-13)

JEDEC TYPE NUMBER†	NOMINAL ZENER VOLTAGE Vz VOLTS	TEST CURRENT IZT mA	MAXIMUM ZENER IMPEDANCE			MAXIMUM REVERSE LEAKAGE CURRENT		MAXIMUM DC ZENER CURRENT IZM mA	TYPICAL TEMPERATURE COEFFICIENT @ IZT %/°C		
			Z _{ZT} @ I _{ZT} Ohms	Z _{ZK} @ I _{ZK} Ohms	I _R @ 25°C μA	V _{R1} * VOLTS	I _R @ 25°C μA			V _{R2} ** VOLTS	
1N3016	6.8	37	3.5	700	1.0	150	5.2	150	4.9	130	.040
1N3017	7.5	34	4.0	700	0.5	75	5.7	75	5.4	120	.045
1N3018	8.2	31	4.5	700	0.5	50	6.2	50	5.9	105	.048
1N3019	9.1	28	5.0	700	0.5	25	6.9	25	6.6	95	.051
1N3020	10	25	7	700	0.25	10	7.6	10	7.2	85	.055
1N3021	11	23	8	700	0.25	5	8.4	5	8.0	75	.060
1N3022	12	21	9	700	0.25	5	9.1	5	8.6	70	.065
1N3023	13	19	10	700	0.25	5	9.9	5	9.4	65	.065
1N3024	15	17	14	700	0.25	5	11.4	5	10.8	56	.070
1N3025	16	15.5	16	700	0.25	5	12.2	5	11.5	53	.070
1N3026	18	14	20	750	0.25	5	13.7	5	13.0	46	.075
1N3027	20	12.5	22	750	0.25	5	15.2	5	14.4	42	.075
1N3028	22	11.5	23	750	0.25	5	16.7	5	15.8	38	.080
1N3029	24	10.5	25	750	0.25	5	18.2	5	17.3	35	.080
1N3030	27	9.5	35	750	0.25	5	20.6	5	19.4	30	.085
1N3031	30	8.5	40	1000	0.25	5	22.8	5	21.6	28	.085
1N3032	33	7.5	45	1000	0.25	5	25.1	5	23.8	26	.085
1N3033	36	7.0	50	1000	0.25	5	27.4	5	25.9	24	.085
1N3034	39	6.5	60	1000	0.25	5	29.7	5	28.1	20	.090
1N3035	43	6.0	70	1500	0.25	5	32.7	5	31.0	19	.090
1N3036	47	5.5	80	1500	0.25	5	35.8	5	33.8	17	.090
1N3037	51	5.0	95	1500	0.25	5	38.8	5	36.7	16	.090
1N3038	56	4.5	110	2000	0.25	5	42.6	5	40.3	15	.090
1N3039	62	4.0	125	2000	0.25	5	47.1	5	44.6	13	.090
1N3040	68	3.7	150	2000	0.25	5	51.7	5	49.0	12	.090
1N3041	75	3.3	175	2000	0.25	5	56.0	5	54.0	11	.090
1N3042	82	3.0	200	3000	0.25	5	62.2	5	59.0	10	.090
1N3043	91	2.8	250	3000	0.25	5	69.2	5	65.5	9	.090
1N3044	100	2.5	350	3000	0.25	5	76.0	5	72.0	8	.090
1N3045	110	2.3	450	4000	0.25	5	83.6	5	79.2	7.2	.095
1N3046	120	2.0	550	4500	0.25	5	91.2	5	86.4	7.0	.095
1N3047	130	1.9	700	5000	0.25	5	98.8	5	93.6	6.0	.095
1N3048	150	1.7	1000	6000	0.25	5	114.0	5	108.0	5.5	.095
1N3049	160	1.6	1100	6500	0.25	5	121.6	5	115.2	5.2	.095
1N3050	180	1.4	1200	7000	0.25	5	136.8	5	129.6	4.6	.095
1N3051	200	1.2	1500	8000	0.25	5	152.0	5	144.0	4.0	.100

Derating Factor above 25°C: 6.67 mW/°C

† Non Suffix Vz = ±20%

A Suffix Vz = ±10%

B Suffix Vz = ±5%

Standard Polarity – Cathode to Case

*VR1 -- Test Voltage for 5% Tolerance Device

**VR2 -- Test Voltage for 10% Tolerance Device

No Leakage Specified for 20% Tolerance Device

1 WATT, Metal (Case DO-13)

JEDEC TYPE NUMBER†	NOMINAL ZENER VOLTAGE Vz VOLTS	TEST CURRENT IZT mA	MAXIMUM ZENER IMPEDANCE			MAXIMUM REVERSE LEAKAGE CURRENT		MAXIMUM DC ZENER CURRENT	
			Z _{ZT} @ I _{ZT} Ohms	Z _{ZK} @ I _{ZK} Ohms	I _{ZK} mA	I _R @ 25°C μA	V _{R1} * VOLTS	I _{ZM} mA	
1N3821	3.3	76	10	400	1.0	100	1	276	
1N3822	3.6	69	10	400	1.0	100	1	252	
1N3823	3.9	64	9	400	1.0	50	1	238	
1N3824	4.3	58	9	400	1.0	10	1	213	
1N3825	4.7	53	8	500	1.0	10	1	194	
1N3826	5.1	49	7	550	1.0	10	1	178	
1N3827	5.6	45	5	600	1.0	10	2	162	
1N3828	6.2	41	2	700	1.0	10	3	146	
1N3829	6.8	37	1.5	500	1.0	10	3	133	
1N3830	7.5	34	1.5	250	1.0	10	3	121	

Derating Factor above 25°C: 6.67 mW/°C

† Non Suffix Vz = ±10%

A Suffix Vz = ±5%

Standard Polarity – Cathode to Case

*VR1 -- Test Voltage for 5% Tolerance Device

**VR2 -- Test Voltage for 10% Tolerance Device

No Leakage Specified for 20% Tolerance Device

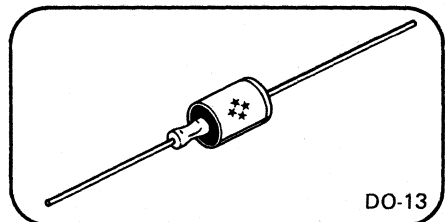

DO-13

1 WATT, Molded (Case DO-41)

JEDEC TYPE NUMBER †	NOMINAL ZENER VOLTAGE V _Z VOLTS	TEST CURRENT I _{ZT} mA	MAXIMUM ZENER IMPEDANCE			MAXIMUM REVERSE LEAKAGE CURRENT			MAXIMUM DC ZENER CURRENT I _{ZM} mA
			Z _{ZT} @ I _{ZT} Ohms	Z _{ZK} Ohms	@ I _{ZK} mA	I _R μA	@ V _{R1} * VOLTS	V _{R2} ** VOLTS	
1N3675	6.8	18.5	4.5	700	1.0	150	5.2	4.9	100
1N3676	7.5	16.5	5.5	700	0.5	75	5.7	5.4	90
1N3677	8.2	15.0	6.5	700	0.5	50	6.2	5.9	80
1N3678	9.1	14.0	7.5	700	0.5	25	6.9	6.6	70
1N3679	10	12.5	8.5	700	0.25	10	7.6	7.2	65
1N3680	11	11.5	9.5	700	0.25	5	8.4	8.0	55
1N3681	12	10.5	11.5	700	0.25	5	9.1	9.6	53
1N3682	13	9.5	13.0	700	0.25	5	9.9	9.4	50
1N3683	15	8.5	16.0	700	0.25	5	11.4	10.8	42
1N3684	16	7.8	17.0	700	0.25	5	12.1	11.5	40
1N3685	18	7.0	21.0	750	0.25	5	13.7	13.0	35
1N3686	20	6.2	25.0	750	0.25	5	15.2	14.4	32
1N3687	22	5.6	29.0	750	0.25	5	16.7	15.8	29
1N3688	24	5.2	33.0	750	0.25	5	18.2	17.3	26
1N3689	27	4.6	41.0	750	0.25	5	20.6	19.4	23
1N3690	30	4.2	49.0	1000	0.25	5	22.8	21.6	21
1N3691	33	3.8	58.0	1000	0.25	5	25.1	23.8	20
1N3692	36	3.4	70.0	1000	0.25	5	27.4	25.9	18
1N3693	39	3.2	80.0	1000	0.25	5	29.7	28.1	15
1N3694	43	3.0	93.0	1500	0.25	5	32.7	31.0	14
1N3695	47	2.7	105.0	1500	0.25	5	35.8	33.8	13
1N3696	51	2.5	125.0	1500	0.25	5	38.8	36.7	12.2
1N3697	56	2.2	150.0	2000	0.25	5	42.6	40.3	11
1N3698	62	2.0	185.0	2000	0.25	5	47.1	44.6	10
1N3699	68	1.8	230.0	2000	0.25	5	51.7	49.0	9.0
1N3700	75	1.7	270.0	2000	0.25	5	56.0	54.0	8.5
1N3701	82	1.5	330.0	3000	0.25	5	62.2	59.0	7.5
1N3702	91	1.4	400.0	3000	0.25	5	69.2	65.5	7.0
1N3703	100	1.3	500.0	3000	0.25	5	76.0	72.0	6.0
1N3704	110	1.1	750.0	4000	0.25	5	83.6	79.2	5.4
1N3705	120	1.0	900.0	4500	0.25	5	91.2	86.4	5.2
1N3706	130	0.95	1100.0	5000	0.25	5	98.8	93.6	4.5
1N3707	150	0.85	1500.0	6000	0.25	5	114.0	108.0	3.7
1N3708	160	0.80	1700.0	6500	0.25	5	121.6	115.2	3.6
1N3709	180	0.68	2200.0	7000	0.25	5	136.8	129.6	3.4
1N3710	200	0.65	2500.0	8000	0.25	5	152.0	144.0	3.0

† Non Suffix V_Z = ±20%

A Suffix V_Z = ±10%

B Suffix V_Z = ±5%

*V_{R1} - Test Voltage for 5% Tolerance Device

**V_{R2} - Test Voltage for 10% Tolerance Device

No Leakage Specified for 20% Tolerance Device

Polarity - Banded End Positive

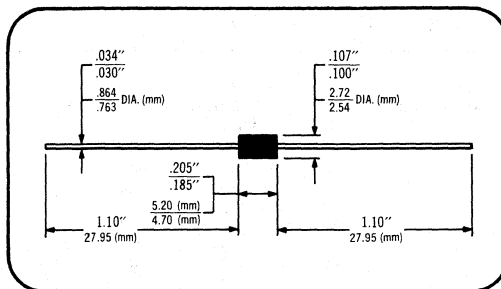
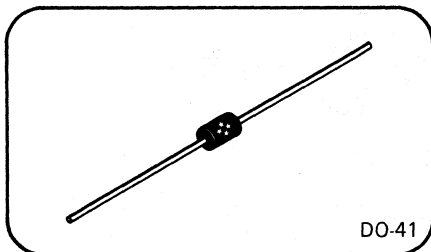

1 WATT, Molded (Case DO-41)

JEDEC TYPE NUMBER †	NOMINAL ZENNER VOLTAGE V _Z VOLTS	TEST CURRENT I _{ZT} mA	MAXIMUM ZENER IMPEDANCE			MAXIMUM REVERSE LEAKAGE CURRENT I _R @ 25°C @ V _R VOLTS		MAXIMUM DC ZENER CURRENT I _{ZM} mA	MAXIMUM SURGE CURRENT I _S mA
			Z _{ZT} @ I _{ZT} Ohms	Z _{ZK} Ohms	@ I _{ZK} mA	μA			
1N4728	3.3	76	10	400	1	100	1	276	1380
1N4729	3.6	69	10	400	1	100	1	252	1260
1N4730	3.9	64	9	400	1	50	1	234	1190
1N4731	4.3	58	9	400	1	10	1	217	1070
1N4732	4.7	53	8	500	1	10	1	193	970
1N4733	5.1	49	7	550	1	10	1	178	890
1N4734	5.6	45	5	600	1	10	2	162	810
1N4735	6.2	41	2	700	1	10	3	146	730
1N4736	6.8	37	3.5	700	1	10	4	133	660
1N4737	7.5	34	4	700	.5	10	5	121	605
1N4738	8.2	31	4.5	700	.5	10	6	110	550
1N4739	9.1	28	5	700	.5	10	7	100	500
1N4740	10	25	7	700	.25	10	7.6	91	454
1N4741	11	23	8	700	.25	5	8.4	83	414
1N4742	12	21	9	700	.25	5	9.1	76	380
1N4743	13	19	10	700	.25	5	9.9	69	344
1N4744	15	17	14	700	.25	5	11.4	61	304
1N4745	16	15.5	16	700	.25	5	12.2	57	285
1N4746	18	14	20	750	.25	5	13.7	50	250
1N4747	20	12.5	22	750	.25	5	15.2	45	225
1N4748	22	11.5	23	750	.25	5	16.7	41	205
1N4749	24	10.5	25	750	.25	5	18.2	38	190
1N4750	27	9.5	35	750	.25	5	20.6	34	170
1N4751	30	8.5	40	1000	.25	5	22.8	30	150
1N4752	33	7.5	45	1000	.25	5	25.1	27	135
1N4753	36	7	50	1000	.25	5	27.4	25	125
1N4754	39	6.5	60	1000	.25	5	29.7	23	115
1N4755	43	6	70	1500	.25	5	32.7	22	110
1N4756	47	5.5	80	1500	.25	5	35.8	19	95
1N4757	51	5	95	1500	.25	5	38.8	18	90
1N4758	56	4.5	110	2000	.25	5	42.6	16	80
1N4759	62	4	125	2000	.25	5	47.1	14	70
1N4760	68	3.7	150	2000	.25	5	51.1	13	65
1N4761	75	3.3	175	2000	.25	5	56	12	60
1N4762	82	3	200	3000	.25	5	62.2	11	55
1N4763	91	2.8	250	3000	.25	5	69.2	10	50
1N4764	100	2.5	350	3000	.25	5	76	9	45

Derating Factor above 50°C: 6.67 mW/°C

† Non Suffix V_Z = ±10%

A Suffix V_Z = ±5%

Polarity - Banded End Positive

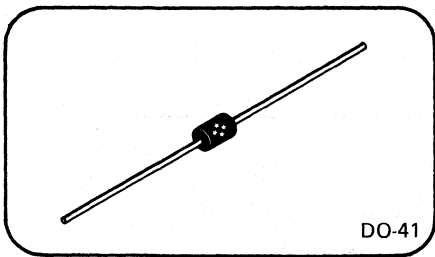

2 WATT, Molded (Case DO-41)

JEDEC TYPE NUMBER †	NOMINAL ZENER VOLTAGE V _Z VOLTS	TEST CURRENT I _{ZT} mA	MAXIMUM ZENER IMPEDANCE Z _{KT} @ I _{ZT} Ohms	MAXIMUM REVERSE LEAKAGE CURRENT I _R @ 25°C @ V _R μA VOLTS	TYPICAL TEMPERATURE COEFFICIENT @ I _{ZT} %/°C	
LMZ3.3A	3.3	151.5	6.0	100	1	.075
LMZ3.6A	3.6	139.0	5.5	100	1	.070
LMZ3.9A	3.9	128.0	5.0	50	1	.060
LMZ4.3A	4.3	116.0	5.0	10	1	.050
LMZ4.7A	4.7	106.0	4.5	10	1	.025
LMZ5.1A	5.1	98.0	4.0	10	1	.030
LMZ5.6A	5.6	89.5	4.0	10	2	.040
LMZ6.2A	6.2	80.5	4.5	10	3	.050
LMZ6.8A	6.8	73.5	5.0	10	3	.057
LMZ7.5A	7.5	66.5	5.5	10	3	.061
LMZ8.2A	8.2	61.0	2.3	10	4.5	.065
LMZ9.1A	9.1	55.0	2.5	10	5.0	.068
LMZ10A	10.0	50.0	3.5	10	6.0	.071
LMZ11A	11.0	45.5	4.0	10	7.0	.073
LMZ12A	12.0	41.5	4.5	10	8.0	.076
LMZ13A	13.0	38.5	5.0	10	9.0	.079
LMZ14A	14.0	35.5	5.5	10	9.5	.080
LMZ15A	15.0	33.5	7.0	10	10.0	.082
LMZ16A	16.0	31.0	8.0	10	11.0	.083
LMZ18A	18.0	28.0	10.0	10	12.0	.085
LMZ20A	20.0	25.0	11.0	10	13.0	.086
LMZ22A	22.0	22.5	11.5	10	15.0	.087
LMZ24A	24.0	21.0	12.5	10	16.0	.088
LMZ27A	27.0	18.5	17.5	5	18.0	.090
LMZ30A	30.0	16.5	20.0	5	19.0	.091
LMZ33A	33.0	15.0	22.5	5	21.0	.092
LMZ36A	36.0	14.0	25.0	5	23.0	.093
LMZ39A	39.0	13.0	30.0	5	25.0	.094
LMZ43A	43.0	11.5	35.0	5	30.0	.095
LMZ47A	47.0	10.5	40.0	5	35.0	.095
LMZ51A	51.0	10.0	45.5	5	38.0	.096
LMZ56A	56.0	9.0	55.0	5	40.0	.096
LMZ62A	62.0	8.0	60.0	5	45.0	.097
LMZ68A	68.0	7.5	75.0	5	50.0	.097
LMZ75A	75.0	6.5	87.5	5	55.0	.098
LMZ82A	82.0	6.0	100.0	5	60.0	.098
LMZ91A	91.0	5.0	125.0	5	65.0	.099
LMZ100A	100.0	5.0	175.0	5	70.0	.100
LMZ110A	110.0	4.5	250.0	5	75.0	.100
LMZ120A	120.0	4.0	325.0	5	80.0	.100
LMZ130A	130.0	4.0	400.0	5	85.0	.100
LMZ150A	150.0	3.5	575.0	5	90.0	.100
LMZ160A	160.0	3.0	650.0	5	90.0	.100
LMZ180A	180.0	3.0	725.0	5	120.0	.100
LMZ200A	200.0	2.5	900.0	5	130.0	.100

LMZX Series devices with only zener voltage measured available for less critical applications.

† Non Suffix V_Z = ±10%

A Suffix V_Z = ±5%

For Double Anode use C or CA Suffix

Polarity - Banded End Positive

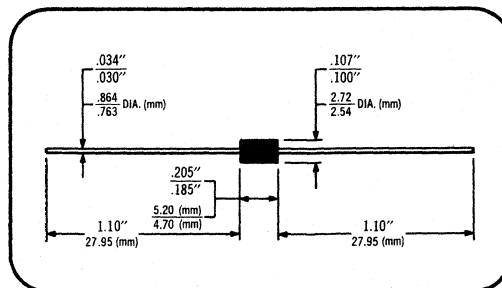
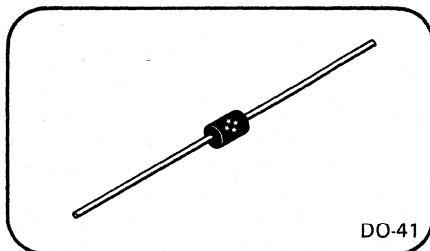

2.5 WATT, Molded (Case 7)

JEDEC TYPE NUMBER †	NOMINAL ZENER VOLTAGE Vz VOLTS	TEST CURRENT Izt mA	MAXIMUM ZENER IMPEDANCE			MAXIMUM REVERSE LEAKAGE CURRENT Ir @ 25°C		MAXIMUM DC ZENER CURRENT Izm mA	TYPICAL TEMPERATURE COEFFICIENT @ Izt %/°C	MAXIMUM SURGE CURRENT Is AMPS
			Zzt @ Izt Ohms	Zzk @ Izk Ohms	@ Izk mA	@ 25°C μA	Vr VOLTS			
1N5008A	3.3	189.0	6.0	400	1.0	100	1.0	722	-.066	6.0
1N5009A	3.6	173.0	5.5	400	1.0	100	1.0	661	.058	5.5
1N5010A	3.9	160.0	5.0	400	1.0	100	1.0	612	.046	5.1
1N5011A	4.3	145.0	4.0	400	1.0	100	1.0	555	.033	4.6
1N5012A	4.7	133.0	3.5	500	1.0	50	1.0	507	±.015	4.2
1N5013A	5.1	122.0	3.0	550	1.0	10	1.0	467	±.010	3.9
1N5014A	5.6	111.0	2.5	600	1.0	10	2.0	425	+0.30	3.5
1N5015A	6.2	101.0	3.0	700	1.0	10	3.0	384	.049	3.3
1N5016A	6.8	92.0	1.6	700	1.0	150	5.2	350	.040	18.0
1N5017A	7.5	83.0	1.8	700	.5	50	5.7	318	.045	16.0
1N5018A	8.2	76.0	2.1	700	.5	10	6.2	290	.048	15.0
1N5019A	9.1	69.0	2.4	700	.5	10	6.9	262	.050	13.0
1N5020A	10.0	62.0	3.0	700	.25	10	7.6	238	.055	12.0
1N5021A	11.0	57.0	3.6	700	.25	10	8.4	216	.060	11.0
1N5022A	12.0	52.0	4.2	700	.25	10	9.1	198	.065	10.0
1N5023A	13.0	48.0	4.8	700	.25	10	9.9	183	.065	9.6
1N5024A	14.0	45.0	5.4	700	.25	10	10.6	170	.070	8.9
1N5025A	15.0	42.0	6.0	700	.25	10	11.4	159	.070	8.3
1N5026A	16.0	39.0	6.6	700	.25	10	12.2	149	.070	7.8
1N5027A	17.0	37.0	7.2	700	.25	10	12.9	140	.075	7.3
1N5028A	18.0	35.0	7.8	750	.25	10	13.7	132	.075	6.9
1N5029A	19.0	33.0	8.4	750	.25	10	14.4	125	.075	6.5
1N5030A	20.0	31.0	9.0	750	.25	10	15.2	119	.075	6.2
1N5031A	22.0	28.0	9.6	750	.25	10	16.7	108	.080	5.6
1N5032A	24.0	26.0	10.0	750	.25	10	18.2	99	.080	5.2
1N5033A	25.0	25.0	11.0	750	.25	10	19.0	99	.085	5.0
1N5034A	27.0	23.0	12.0	750	.25	10	20.5	88	.085	4.6
1N5035A	30.0	21.0	15.0	1000	.25	10	22.8	79	.085	4.1
1N5036A	33.0	19.0	18.0	1000	.25	10	25.1	72	.085	3.7
1N5037A	36.0	17.0	21.0	1000	.25	10	27.4	66	.085	3.4
1N5038A	39.0	16.0	24.0	1000	.25	10	29.6	61	.090	3.2
1N5039A	43.0	15.0	27.0	1500	.25	10	32.7	55	.090	2.9
1N5040A	45.0	14.0	30.0	1500	.25	10	34.2	53	.090	2.7
1N5041A	47.0	13.0	33.0	1500	.25	10	35.7	50	.090	2.6
1N5042A	50.0	12.0	36.0	1500	.25	10	38.0	47	.090	2.5
1N5043A	51.0	12.0	36.0	1500	.25	10	38.8	46	.090	2.4
1N5044A	52.0	12.0	39.0	2000	.25	10	39.5	45	.090	2.4
1N5045A	56.0	11.0	45.0	2000	.25	10	42.6	42	.090	2.2
1N5046A	62.0	10.0	51.0	2000	.25	10	47.1	38	.090	2.0
1N5047A	68.0	9.2	57.0	2000	.25	10	51.7	35	.090	1.8
1N5048A	75.0	8.3	66.0	2000	.25	10	57.0	31	.090	1.6
1N5049A	82.0	7.6	78.0	3000	.25	10	62.3	29	.090	1.5
1N5050A	91.0	6.9	90.0	3000	.25	10	69.2	26	.090	1.3
1N5051A	100.0	6.2	120.0	3000	.25	10	76.0	23	.090	1.2

Vf = 1.2 Volts max. @ 500 mA

Polarity - Banded End Positive

† Non Suffix Vz = ±10%

A Suffix Vz = ±5%

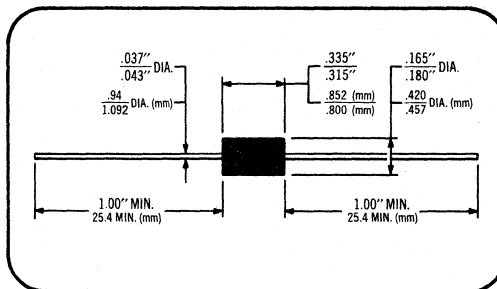
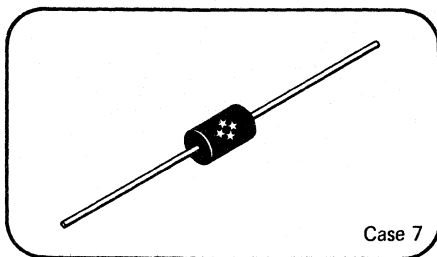

5 WATT, Molded (Case 7)

JEDEC TYPE NUMBER †	NOMINAL ZENER VOLTAGE V _Z VOLTS	TEST CURRENT I _{ZT} mA	MAXIMUM ZENER IMPEDANCE A & B SUFFIX ONLY			MAXIMUM REVERSE LEAKAGE CURRENT			MAXIMUM DC ZENER CURRENT I _{ZM} mA	VOLTAGE REGULATION ΔV ***	MAXIMUM SURGE CURRENT I _S A
			Z _{ZT} @ I _{ZT} Ohms	Z _{ZK} Ohms	@ I _{ZK} mA	I _R μA	@ V _{R1} * @ 25°C VOLTS	V _{R2} ** VOLTS			
1N5333	3.3	380	3.0	400	1.0	300.0	1.0	1.0	1440	0.85	20.0
1N5334	3.6	350	2.5	500	1.0	150.0	1.0	1.0	1320	0.80	18.7
1N5335	3.9	320	2.0	500	1.0	50.0	1.0	1.0	1220	0.54	17.6
1N5336	4.3	290	2.0	500	1.0	10.0	1.0	1.0	1100	0.49	16.4
1N5337	4.7	260	2.0	450	1.0	5.0	1.0	1.0	1010	0.44	15.3
1N5338	5.1	240	1.5	400	1.0	1.0	1.0	1.0	930	0.39	14.4
1N5339	5.6	220	1.0	400	1.0	1.0	2.0	2.0	865	0.25	13.4
1N5340	6.0	200	1.0	300	1.0	1.0	3.0	3.0	790	0.19	12.7
1N5341	6.2	200	1.0	200	1.0	1.0	3.0	3.0	765	0.10	12.4
1N5342	6.8	175	1.0	200	1.0	10.0	5.2	4.9	700	0.15	11.5
1N5343	7.5	175	1.5	200	1.0	10.0	5.7	5.4	630	0.15	10.7
1N5344	8.2	150	1.5	200	1.0	10.0	6.2	5.9	580	0.20	10.0
1N5345	8.7	150	2.0	200	1.0	10.0	6.6	6.3	545	0.20	9.5
1N5346	9.1	150	2.0	150	1.0	7.5	6.9	6.6	520	0.22	9.2
1N5347	10	125	2.0	125	1.0	5.0	7.6	7.2	475	0.22	8.6
1N5348	11	125	2.5	125	1.0	5.0	8.4	8.0	430	0.25	8.0
1N5349	12	100	2.5	125	1.0	2.0	9.1	8.6	395	0.25	7.5
1N5350	13	100	2.5	100	1.0	1.0	9.9	9.4	365	0.25	7.0
1N5351	14	100	2.5	75	1.0	1.0	10.6	10.1	340	0.25	6.7
1N5352	15	75	2.5	75	1.0	1.0	11.5	10.8	315	0.25	6.3
1N5353	16	75	2.5	75	1.0	1.0	12.2	11.5	295	0.30	6.0
1N5354	17	70	2.5	75	1.0	0.5	12.9	12.2	280	0.35	5.8
1N5355	18	65	2.5	75	1.0	0.5	13.7	13.0	264	0.40	5.5
1N5356	19	65	3.0	75	1.0	0.5	14.4	13.7	250	0.40	5.3
1N5357	20	65	3.0	75	1.0	0.5	15.2	14.4	237	0.40	5.1
1N5358	22	50	3.5	75	1.0	0.5	16.7	15.8	216	0.45	4.7
1N5359	24	50	3.5	100	1.0	0.5	18.2	17.3	198	0.55	4.4
1N5360	25	50	4.0	110	1.0	0.5	19.0	18.0	190	0.55	4.3
1N5361	27	50	5.0	120	1.0	0.5	20.6	19.4	176	0.60	4.1
1N5362	28	50	6.0	130	1.0	0.5	21.2	20.1	170	0.60	3.9
1N5363	30	40	8.0	140	1.0	0.5	22.8	21.6	158	0.60	3.7
1N5364	33	40	10.0	150	1.0	0.5	25.1	23.8	144	0.60	3.5
1N5365	36	30	11.0	160	1.0	0.5	27.4	25.9	132	0.65	3.3
1N5366	39	30	14.0	170	1.0	0.5	29.7	28.1	122	0.65	3.1
1N5367	43	30	20.0	190	1.0	0.5	32.7	31.0	110	0.70	2.8
1N5368	47	25	25.0	210	1.0	0.5	35.8	33.8	100	0.80	2.7
1N5369	51	25	27.0	230	1.0	0.5	38.8	36.7	93.0	0.90	2.5
1N5370	56	20	35.0	280	1.0	0.5	42.6	40.3	86.0	1.00	2.3
1N5371	60	20	40.0	350	1.0	0.5	45.5	43.0	79.0	1.20	2.2
1N5372	62	20	42.0	400	1.0	0.5	47.1	44.6	76.0	1.35	2.1
1N5373	68	20	44.0	500	1.0	0.5	51.7	49.0	70.0	1.50	2.0
1N5374	75	20	45.0	620	1.0	0.5	56.0	54.0	63.0	1.60	1.9
1N5375	82	15	65.0	720	1.0	0.5	62.2	59.0	58.0	1.80	1.8
1N5376	87	15	75.0	760	1.0	0.5	66.0	63.0	54.5	2.00	1.7
1N5377	91	15	75.0	760	1.0	0.5	69.2	65.5	52.5	2.20	1.6
1N5378	100	12	90.0	800	1.0	0.5	76.0	72.0	47.5	2.50	1.5
1N5379	110	12	125.0	1000	1.0	0.5	83.6	79.2	43.0	2.50	1.4
1N5380	120	10	170.0	1150	1.0	0.5	91.2	86.4	39.5	2.50	1.3
1N5381	130	10	190.0	1250	1.0	0.5	98.8	93.6	36.6	2.50	1.2
1N5382	140	8.0	230.0	1500	1.0	0.5	106.0	101.0	34.0	2.50	1.2
1N5383	150	8.0	330.0	1500	1.0	0.5	114.0	108.0	31.6	3.00	1.1
1N5384	160	8.0	350.0	1650	1.0	0.5	122.0	11.5	29.4	3.00	1.1
1N5385	170	8.0	380.0	1750	1.0	0.5	129.0	122.0	28.0	3.00	1.0
1N5386	180	5.0	430.0	1750	1.0	0.5	137.0	130.0	26.4	4.00	1.0
1N5387	190	5.0	450.0	1850	1.0	0.5	144.0	137.0	25.0	5.00	0.9
1N5388	200	5.0	480.0	1850	1.0	0.5	152.0	144.0	23.6	5.00	0.9

V_F = 1.2 Volts max. @ I_F = 1.0A for all types

† Non Suffix V_Z = ±20%

A Suffix V_Z = ±10%

B Suffix V_Z = ±5%

Derating Factor above 75°C: 40.0 mW/°C

Polarity - Banded End Positive

*V_{R1} - Test Voltage for 5% Tolerance Device

**V_{R2} - Test Voltage for 10% and 20% Tolerance Devices

***ΔV = V_Z @ 50% I_{ZM} - V_Z @ 10% I_{ZM}

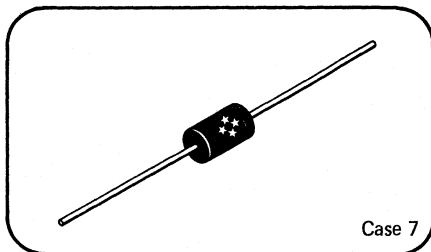

10 WATT, Metal (Case DO-4, 10-32)

JEDEC TYPE NUMBER †	NOMINAL ZENER VOLTAGE V_Z VOLTS	TEST CURRENT I_{ZT} mA	MAXIMUM ZENER IMPEDANCE Z_{ZT} @ I_{ZT} Ohms	MAXIMUM DC ZENER CURRENT I_{ZM} mA	TYPICAL TEMPERATURE COEFFICIENT @ I_{ZT} %/°C
1N1351	10	500	2	910	+0.071
1N1352	11	500	2	830	+0.073
1N1353	12	500	2	780	+0.076
1N1354	13	500	2	700	+0.079
1N1355	15	500	2	610	+0.082
1N1356	16	500	3	570	+0.083
1N1357	18	150	3	500	+0.085
1N1358	20	150	3	450	+0.086
1N1359	22	150	3	410	+0.087
1N1360	24	150	3	380	+0.088
1N1361	27	150	3	340	+0.090
1N1362	30	150	4	300	+0.091
1N1363	33	150	4	275	+0.092
1N1364	36	150	5	252	+0.093
1N1365	39	150	5	233	+0.094
1N1366	43	150	6	212	+0.095
1N1367	47	150	7	193	+0.095
1N1368	51	150	8	178	+0.096
1N1369	56	150	9	162	+0.096
1N1370	62	50	12	147	+0.097
1N1371	68	50	14	134	+0.097
1N1372	75	50	20	121	+0.098
1N1373	82	50	22	111	+0.098
1N1374	91	50	35	100	+0.099
1N1375	100	50	40	91	+0.100

Standard Polarity – Anode to Case

Derating Factor above 55°C case: 91 mW/°C

† Non Suffix $V_Z = \pm 10\%$

A Suffix $V_Z = \pm 5\%$

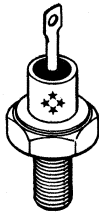

DO-4, 10-32

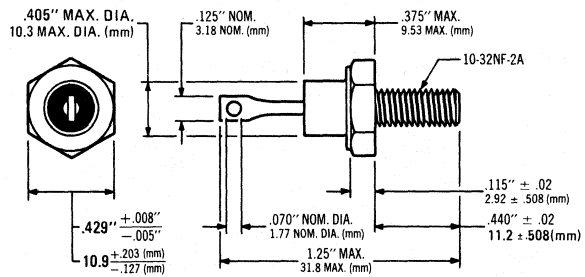

10 WATT, Metal (Case DO-4, 10-32)

JEDEC TYPE NUMBER †	NOMINAL ZENER VOLTAGE V _Z VOLTS	TEST CURRENT I _{ZT} mA	MAXIMUM ZENER IMPEDANCE Z _{ZT} @ I _{ZT} Ohms	MAXIMUM DC ZENER CURRENT I _{ZM} mA	TYPICAL
					TEMPERATURE COEFFICIENT @ I _{ZT} %/°C
1N1588*	3.9	150	4.5	850	-0.04
1N1589*	4.7	125	4.0	700	±0.02
1N1590*	5.6	110	3.0	625	+0.03
1N1591*	6.8	100	.9	525	+0.05
1N1592*	8.2	80	1.5	425	+0.06
1N1593*	10.0	70	2.5	350	+0.07
1N1594*	12.0	50	3.0	275	+0.075
1N1595*	15.0	40	5.5	225	+0.080
1N1596*	18.0	35	9.0	200	+0.085
1N1597*	22.0	30	14.0	160	+0.090
1N1598*	27.0	25	24.0	125	+0.095
1N1599**	3.9	500	1.5	2500	-0.04
1N1600**	4.7	400	.9	2000	±0.02
1N1601**	5.6	350	.6	1750	+0.03
1N1602**	6.8	300	.4	1500	+0.05
1N1603**	8.2	250	.6	1200	+0.06
1N1604**	10.0	200	1.0	1000	+0.07
1N1605**	12.0	170	2.0	850	+0.075
1N1606**	15.0	140	1.90	650	+0.080
1N1607**	18.0	110	4.0	550	+0.085
1N1608**	22.0	90	6.0	450	+0.090
1N1609**	27.0	70	10	350	+0.095

Standard Polarity – Cathode to Case

* Derating Factor above 55°C case: 31.8 mW/°C

** Derating Factor above 55°C case: 91 mW/°C

† Non Suffix V_Z = ±10%

A Suffix V_Z = ±5%

10 WATT, Metal (Case DO-4, 10-32)

JEDEC TYPE NUMBER †	NOMINAL ZENER VOLTAGE V _Z VOLTS	TEST CURRENT I _{ZT} mA	MAXIMUM ZENER IMPEDANCE Z _{ZT} @ I _{ZT} Ohms	MAXIMUM DC ZENER CURRENT I _{ZM} mA	TYPICAL
					TEMPERATURE COEFFICIENT @ I _{ZT} %/°C
1N1803	5.6	1000	1		
1N1804	6.2	1000	1		
1N1805	6.8	1000	1	1340	+0.057
1N1806	7.5	1000	1	1210	+0.061
1N1807	8.2	1000	1	1110	+0.065
1N1808	9.1	500	1	1000	+0.068
1N1809	110	50	47	83	+0.100
1N1810	120	50	56	76	+0.100
1N1811	130	50	65	70	+0.100
1N1812	150	50	82	61	+0.100
1N1813	160	50	93	57	+0.100
1N1814	180	50	115	50	+0.100
1N1815	200	50	140	45	+0.100

† Non Suffix V_Z = ±10%

A Suffix V_Z = ±5%

B Suffix V_Z = ±1%

Standard Polarity – Anode to Case

Derating Factor above 50°C TO-80 mW/°C

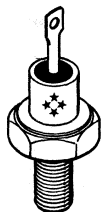

DO-4, 10-32

10 WATT, Metal (Case DO-4, 10-32)

JEDEC TYPE NUMBER †	NOMINAL ZENER VOLTAGE V _Z VOLTS	TEST CURRENT I _{ZT} mA	MAXIMUM ZENER IMPEDANCE Z _{ZT} @ I _{ZT} Ohms		MAXIMUM REVERSE LEAKAGE CURRENT I _R @ V _R @ 25°C μA VOLTS		MAXIMUM DC ZENER CURRENT I _{ZM} mA	TYPICAL TEMPERATURE COEFFICIENT @ I _{ZT} %/°C
1N1816	13	500	2		25	5	700	+0.079
1N1817	15	500	2		15	5	610	+0.082
1N1818	16	500	3		10	5	570	+0.083
1N1819	18	500	3		10	5	500	+0.085
1N1820	20	250	3		10	10	450	+0.086
1N1821	22	250	3		10	10	410	+0.087
1N1822	24	250	3		10	10	380	+0.088
1N1823	27	250	3		10	10	340	+0.090
1N1824	30	250	4		10	10	300	+0.091
1N1825	33	150	4		10	10	275	+0.092
1N1826	36	150	5		10	10	252	+0.093
1N1827	39	150	5		10	10	233	+0.094
1N1828	43	150	6		10	10	212	+0.095
1N1829	47	150	7		10	10	193	+0.095
1N1830	51	150	8		10	10	178	+0.096
1N1831	56	150	9		10	10	162	+0.096
1N1832	62	50	12		10	10	147	+0.097
1N1833	68	50	14		10	10	134	+0.097
1N1834	75	50	20		10	10	121	+0.098
1N1835	82	50	22		10	10	111	+0.098
1N1836	91	50	35		10	10	100	+0.099
1N2008	100	50	40		10	10	91	+0.100
1N2009	110	50	47		10	10	83	+0.100
1N2010	120	50	56		10	10	76	+0.100
1N2011	130	50	65		10	10	70	+0.100
1N2012	150	50	82		10	10	61	+0.100
1N2498	10	500	2		40	5	910	+0.070
1N2499	11	500	2		30	5	830	+0.073
1N2500	12	500	2		25	5	760	+0.076

† Non Suffix V_Z = ±10%

A Suffix V_Z = ±5%

C Suffix V_Z = Bipolar (10%)

CA Suffix V_Z = Bipolar (5%)

Standard Polarity – Anode to Case

Derating Factor above 50°C TO-80 mW/°C

10 WATT, Metal (Case DO-4, 10-32)

JEDEC TYPE NUMBER †	NOMINAL ZENER VOLTAGE V _Z VOLTS	TEST CURRENT I _{ZT} mA	MAXIMUM ZENER IMPEDANCE Z _{ZT} @ I _{ZT} Z _{ZK} @ I _{ZK} Ohms Ohms mA			MAXIMUM REVERSE LEAKAGE CURRENT I _R @ V _R @ 25°C μA VOLTS		MAXIMUM DC ZENER CURRENT I _{ZM} mA	TYPICAL TEMPERATURE COEFFICIENT @ I _{ZT} %/°C
1N3949*	20.0	250	3.0			10	10	480	.080
1N3984**	5.5	1000	.7					1600	
1N3985**	6.0	1000	.7					1600	
1N3986**	6.2	805	1.5	.3	350	1000	4.96	1615	

† Non Suffix V_Z = ±10%

*Standard Polarity – Anode to Case

**Standard Polarity – Cathode to Case

Derating Factor above 50°C TO-80 mW/°C

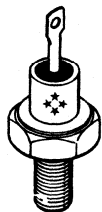

DO-4, 10-32

10 WATT, Metal (Case DO-4, 10-32)

JEDEC TYPE NUMBER	ZENER VOLTAGE V _Z VOLTS			TEST CURRENT I _{ZT} A	MAXIMUM ZENER IMPEDANCE Z _T @ I _{ZT} Ohms	MAXIMUM DC ZENER CURRENT I _{ZM} Amp
	Min.	Nom. (± 5%)	Max.			
1N2041	4.3		5.4	1	1.0	2.0A
1N2041-1		4.5		1	1.0	2.0A
1N2041-2		5.0		1	1.0	2.0A
1N2042	5.2		6.4	1	.7	1.6A
1N2042-1		5.5		1	.7	1.6A
1N2042-2		6.0		1	.7	1.6A
1N2043	6.2		8.0	1	.8	1.2A
1N2043-1		6.5		1	.8	1.2A
1N2043-2		7.0		1	.8	1.2A
1N2043-3		7.5		1	.8	1.2A
1N2044	7.5		10.0	1	.8	1.0A
1N2044-1		8.0		1	.8	1.0A
1N2044-2		8.5		1	.8	1.0A
1N2044-3		9.0		1	.8	1.0A
1N2044-4		9.5		1	.8	1.0A
1N2045	9.0		12.0	.5	1.5	.8A
1N2045-1		10.0		.5	1.5	.8A
1N2045-2		11.0		.5	1.5	.8A
1N2046	11.0		14.5	.5	2.0	.7A
1N2046-1		12.0		.5	2.0	.7A
1N2046-2		13.0		.5	2.0	.7A
1N2046-3		14.0		.5	2.0	.7A
1N2047	13.5		18.0	.5	3.0	.6A
1N2047-1		15.0		.5	3.0	.6A
1N2047-2		16.0		.5	3.0	.6A
1N2047-3		17.0		.5	3.0	.6A
1N2048	17.0		21.0	.5	3.0	.5A
1N2048-1		18.0		.5	3.0	.5A
1N2048-2		19.0		.5	3.0	.5A
1N2048-3		20.0		.5	3.0	.5A
1N2049	20.0		27.0	.15	8.0	.4A
1N2049-1		22.0		.15	8.0	.4A
1N2049-2		24.0		.15	8.0	.4A
1N2049-3		26.0		.15	8.0	.4A

Standard Polarity — Cathode to Case

Derating Factor above 55°C: 66.7 mW/°C

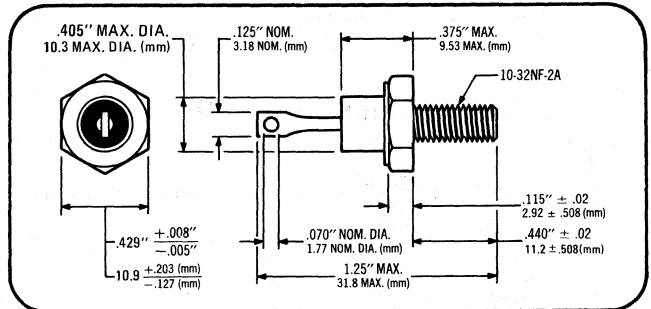
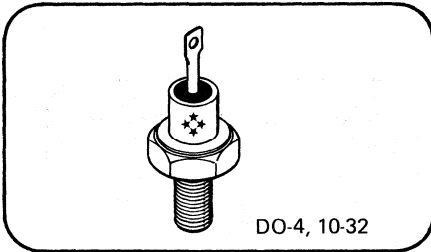

10 WATT, Metal (Case DO-4, 10-32)

JEDEC TYPE NUMBER †	NOMINAL ZENER VOLTAGE Vz VOLTS	TEST CURRENT IZT mA	MAXIMUM ZENER IMPEDANCE			MAXIMUM REVERSE LEAKAGE CURRENT			MAXIMUM DC ZENER CURRENT IZM mA
			ZzT @ IZT Ohms	ZzK @ IZK Ohms	IzK @ IZK mA	IR @ VR1* @ 25°C μA	VR2** VOLTS	VR2** VOLTS	
1N2970B	6.8	370	1.2	500	1.0	150	5.2	4.9	1320
1N2971B	7.5	335	1.3	250	1.0	75	5.7	5.4	1180
1N2972B	8.2	305	1.5	250	1.0	50	6.2	5.9	1040
1N2973B	9.1	275	2.0	250	1.0	25	6.9	6.6	960
1N2974B	10	250	3.0	250	1.0	10	7.6	7.2	860
1N2975B	11	230	3.0	250	1.0	5.0	8.4	8.0	780
1N2976B	12	210	3.0	250	1.0	5.0	9.1	8.6	720
1N2977B	13	190	3.0	250	1.0	5.0	9.9	9.4	660
1N2978B	14	180	3.0	250	1.0	5.0	10.6	10.1	600
1N2979B	15	170	3.0	250	1.0	5.0	11.4	10.8	560
1N2980B	16	155	4.0	250	1.0	5.0	12.2	11.5	530
1N2981B	17	145	4.0	250	1.0	5.0	13.0	12.2	500
1N2982B	18	140	4.0	250	1.0	5.0	13.7	13.0	460
1N2983B	19	130	4.0	250	1.0	5.0	14.4	13.7	440
1N2984B	20	125	4.0	250	1.0	5.0	15.2	14.4	420
1N2985B	22	115	5.0	250	1.0	5.0	16.7	15.8	380
1N2986B	24	105	5.0	250	1.0	5.0	18.2	17.3	350
1N2987B	25	100	6.0	250	1.0	5.0	19.6	18.0	336
1N2988B	27	95	7.0	250	1.0	5.0	20.6	19.4	300
1N2989B	30	85	8.0	300	1.0	5.0	22.8	21.6	280
1N2990B	33	75	9.0	300	1.0	5.0	25.1	23.8	260
1N2991B	36	70	10	300	1.0	5.0	27.4	25.9	230
1N2992B	39	65	11	300	1.0	5.0	29.7	28.1	210
1N2993B	43	60	12	400	1.0	5.0	32.7	31.0	195
1N2994B	45	55	13	400	1.0	5.0	34.2	32.4	186
1N2995B	47	55	14	400	1.0	5.0	35.8	33.8	175
1N2996B	50	50	15	500	1.0	5.0	38.0	36.0	165
1N2997B	51	50	15	500	1.0	5.0	38.8	36.7	163
1N2998B	52	50	15	500	1.0	5.0	39.5	37.4	160
1N2999B	56	45	16	500	1.0	5.0	42.6	40.3	150
1N3000B	62	40	17	600	1.0	5.0	47.1	44.6	130
1N3001B	68	37	18	600	1.0	5.0	51.7	49.0	120
1N3002B	75	33	22	600	1.0	5.0	56.0	54.0	110
1N3003B	82	30	25	700	1.0	5.0	62.2	59.0	100
1N3004B	91	28	35	800	1.0	5.0	69.2	65.5	85
1N3005B	100	25	40	900	1.0	5.0	76.0	72.0	80
1N3006B	105	25	45	1000	1.0	5.0	79.8	75.6	75
1N3007B	110	23	55	1100	1.0	5.0	83.6	79.2	72
1N3008B	120	20	75	1200	1.0	5.0	91.2	86.4	67
1N3009B	130	19	100	1300	1.0	5.0	98.8	93.6	62
1N3010B	140	18	125	1400	1.0	5.0	106.4	100.8	58
1N3011B	150	17	175	1500	1.0	5.0	114.0	108.0	54
1N3012B	160	16	200	1600	1.0	5.0	121.6	115.2	50
1N3014B	180	14	260	1850	1.0	5.0	136.8	129.6	45
1N3015B	200	12	300	2000	1.0	5.0	152.0	144.0	40

Vz @ Tc = 30°C

Vf = 1.5 V max @ If = 2 amp on all types.

† Non Suffix Vz = ±20%

A Suffix Vz = ±10%

B Suffix Vz = ±5%

Standard Polarity – Anode to Case

*Reverse Polarity Available

Available in JAN and JANTX per MIL-S-19500/124

Derating Factor above 55°C: 66.6 mW/°C

*VR1 - Test Voltage for 5% Tolerance Device.

**VR2 - Test Voltage for 10% Tolerance Device.

No Leakage Specified for 20% Tolerance Device

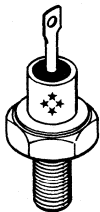

DO-4, 10-32

10 WATT, Metal (Case DO-4, 10-32)

JEDEC TYPE NUMBER†	NOMINAL ZENER VOLTAGE V _Z VOLTS	TEST CURRENT I _{ZT} mA	MAXIMUM ZENER IMPEDANCE			MAXIMUM REVERSE LEAKAGE CURRENT I _R @ V _R @ 25°C		MAXIMUM DC ZENER CURRENT I _{ZM} mA	TYPICAL TEMPERATURE COEFFICIENT @ I _{ZT} %/°C
			Z _{ZT} @ I _{ZT} Ohms	Z _{ZK} Ohms	@ I _{ZK} mA	μA	VOLTS		
1N3993	3.9	640	2.0	400	1	100	.5	2.38A	-.046
1N3994	4.3	580	1.5	400	1	100	.5	2.17	-.033
1N3995	4.7	530	1.2	500	1	50	1	1.94	-.015
1N3996	5.1	490	1.1	550	1	10	1	1.78	±.010
1N3997	5.6	445	1.0	600	1	10	1	1.62	+ .030
1N3998	6.2	405	1.1	750	1	10	2	1.46	+ .049
1N3999	6.8	370	1.2	500	1	10	2	1.33	+ .053
1N4000	7.5	335	1.3	250	1	10	3	1.21	+ .057

Standard Polarity – Cathode to Case

Derating Factor above 55°C: 83.3mW/°C

V_F = 1.5v max. @ 2 amps on all types

† Non Suffix V_Z = ±10%

A Suffix V_Z = ±5%

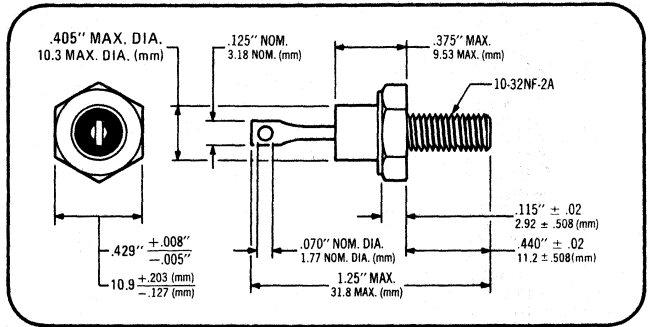
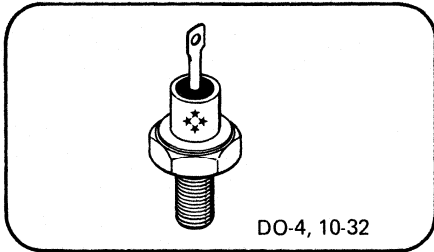

50 WATT, Metal (Case TO-3, .050" Pin Dia.)

JEDEC TYPE NUMBER †	NOMINAL ZENER VOLTAGE Vz VOLTS	TEST CURRENT I _{ZT} mA	MAXIMUM ZENER IMPEDANCE			MAXIMUM REVERSE LEAKAGE CURRENT			MAXIMUM DC ZENER CURRENT I _{ZM} mA	TYPICAL TEMPERATURE COEFFICIENT @ I _{ZT} %/°C
			Z _{ZT} @ I _{ZT} Ohms	Z _{ZK} @ I _{ZK} Ohms	mA	I _r @ V _{R1} * @ 25°C μA	V _{R2} ** VOLTS	V _{R2} ** VOLTS		
1N2804B	6.8	1850	0.2	70	5	150	4.5	4.3	6600	.040
1N2805B	7.5	1700	0.3	70	5	75	5.0	4.7	5900	.045
1N2806B	8.2	1500	0.4	70	5	50	5.4	5.2	5200	.048
1N2807B	9.1	1370	0.5	70	5	25	6.1	5.7	4800	.051
1N2808B	10	1200	0.6	80	5	10	6.7	6.3	4300	.055
1N2809B	11	1100	0.8	80	5	5	8.4	8.0	3900	.060
1N2810B	12	1000	1.0	80	5	5	9.1	8.6	3600	.065
1N2811B	13	960	1.1	80	5	5	9.9	9.4	3300	.065
1N2812B	14	890	1.2	80	5	5	10.6	10.1	3000	.070
1N2813B	15	830	1.4	80	5	5	11.4	10.8	2800	.070
1N2814B	16	780	1.6	80	5	5	12.2	11.5	2650	.070
1N2815B	17	740	1.8	80	5	5	13.0	12.2	2500	.075
1N2816B	18	700	2.0	80	5	5	13.7	13.0	2300	.075
1N2817B	19	660	2.2	80	5	5	14.4	13.7	2200	.075
1N2818B	20	630	2.4	80	5	5	15.2	14.4	2100	.075
1N2819B	22	570	2.5	80	5	5	16.7	15.8	1900	.080
1N2820B	24	520	2.6	80	5	5	18.2	17.3	1750	.080
1N2821B	25	500	2.7	90	5	5	19.0	18.0	1550	.080
1N2822B	27	460	2.8	90	5	5	20.6	19.4	1500	.085
1N2823B	30	420	3.0	90	5	5	22.8	21.6	1400	.085
1N2824B	33	380	3.2	90	5	5	25.1	23.8	1300	.085
1N2825B	36	350	3.5	90	5	5	27.4	25.9	1150	.085
1N2826B	39	320	4.0	90	5	5	29.7	28.1	1050	.090
1N2827B	43	290	4.5	90	5	5	32.7	31.0	975	.090
1N2828B	45	280	4.5	100	5	5	34.2	32.4	930	.090
1N2829B	47	270	5.0	100	5	5	35.8	33.8	880	.090
1N2830B	50	250	5.0	100	5	5	38.0	36.0	830	.090
1N2831B	51	245	5.2	100	5	5	38.8	36.7	810	.090
1N2832B	56	220	6	110	5	5	42.6	40.3	740	.090
1N2833B	62	200	7	120	5	5	47.1	44.6	660	.090
1N2834B	68	180	8	140	5	5	51.7	49.0	600	.090
1N2835B	75	170	9	150	5	5	56.0	54.0	540	.090
1N2836B	82	150	11	160	5	5	62.2	59.0	490	.090
1N2837B	91	140	15	180	5	5	69.2	65.5	420	.090
1N2838B	100	120	20	200	5	5	76.0	72.0	400	.090
1N2839B	105	120	25	210	5	5	79.8	75.6	380	.095
1N2840B	110	110	30	220	5	5	83.6	79.2	365	.095
1N2841B	120	100	40	240	5	5	91.2	86.4	335	.095
1N2842B	130	95	50	275	5	5	98.8	93.6	310	.095
1N2843B	150	85	75	400	5	5	114.0	108.0	270	.095
1N2844B	160	80	80	450	5	5	121.6	115.2	250	.095
1N2845B	180	68	90	525	5	5	136.8	129.6	220	.095
1N2846B	200	65	100	600	5	5	152.0	144.0	200	.100

ZENER DIODES

V_Z @ T_C = 30°C

V_F = 1.5 max @ 10 A on all types.

Standard Polarity – Anode to Case

† Non-Suffix V_Z = ±20%

A Suffix V_Z = ±10%

B Suffix V_Z = ±5%

*VR1 – Test Voltage for 5% Tolerance Device, Suffix B

**VR2 – Test Voltage for 10% Tolerance Device, Suffix A

No Leakage Specified for 20% Tolerance Device, Non Suffix

Available in JAN and JANTX per MIL-S-19500/114

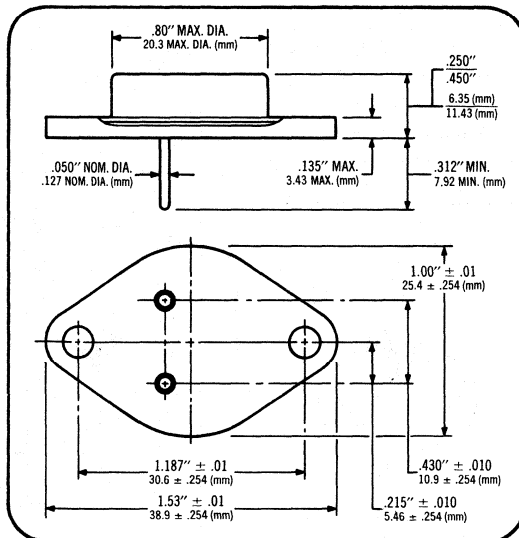
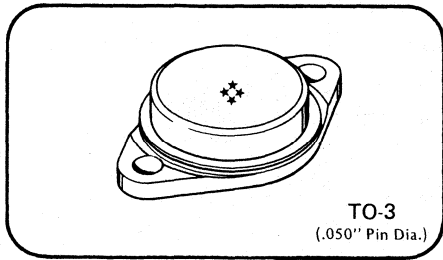

50 WATT, Metal (Case DO-5, 1/4-28)

JEDEC TYPE NUMBER †	NOMINAL ZENER VOLTAGE V _Z VOLTS	TEST CURRENT I _{ZT} mA	MAXIMUM ZENER IMPEDANCE			MAXIMUM REVERSE LEAKAGE CURRENT			MAXIMUM DC ZENER CURRENT I _{ZM} mA	TYPICAL TEMPERATURE COEFFICIENT @ I _{ZT} %/°C
			Z _{ZT} @ I _{ZT}	Z _{ZK} @ I _{ZK}	I _r @ V _{R1} *	V _{R1} * @ 25°C	V _{R2} **			
			Ohms	Ohms	μA	VOLTS	VOLTS			
1N3305B	6.8	1850	0.2	150	5	300	4.5	4.3	6600	.040
1N3306B	7.5	1700	0.3	100	5	125	5.0	4.7	5900	.045
1N3307B	8.2	1500	0.4	70	5	50	5.4	5.2	5200	.048
1N3308B	9.1	1370	0.5	70	5	25	6.1	5.7	4800	.051
1N3309B	10	1200	0.6	80	5	10	6.7	6.3	4300	.055
1N3310B	11	1100	0.8	80	5	5	8.4	8.0	3900	.060
1N3311B	12	1000	1.0	80	5	5	9.1	8.6	3600	.065
1N3312B	13	960	1.1	80	5	5	9.9	9.4	3300	.065
1N3313B	14	890	1.2	80	5	5	10.6	10.1	3000	.070
1N3314B	15	830	1.4	80	5	5	11.4	10.8	2800	.070
1N3315B	16	780	1.6	80	5	5	12.2	11.5	2650	.070
1N3316B	17	740	1.8	80	5	5	13.0	12.2	2500	.075
1N3317B	18	700	2.0	80	5	5	13.7	13.0	2300	.075
1N3318B	19	660	2.2	80	5	5	14.4	13.7	2200	.075
1N3319B	20	630	2.4	80	5	5	15.2	14.4	2100	.075
1N3320B	22	570	2.5	80	5	5	16.7	15.8	1900	.080
1N3321B	24	520	2.6	80	5	5	18.2	17.3	1750	.080
1N3322B	25	500	2.7	90	5	5	19.0	18.0	1550	.080
1N3323B	27	460	2.8	90	5	5	20.6	19.4	1500	.085
1N3324B	30	420	3.0	90	5	5	22.8	21.6	1400	.085
1N3325B	33	380	3.2	90	5	5	25.1	23.8	1300	.085
1N3326B	36	350	3.5	90	5	5	27.4	25.9	1150	.085
1N3327B	39	320	4.0	90	5	5	29.7	28.1	1050	.090
1N3328B	43	290	4.5	90	5	5	32.7	31.0	975	.090
1N3329B	45	280	4.5	100	5	5	34.2	32.4	930	.090
1N3330B	47	270	5.0	100	5	5	35.8	33.8	880	.090
1N3331B	50	250	5.0	100	5	5	38.0	36.0	830	.090
1N3332B	51	245	5.2	100	5	5	38.8	36.7	810	.090
1N3333B	52	240	5.5	100	5	5	39.5	37.4	790	.090
1N3334B	56	220	6	110	5	5	42.6	40.3	740	.090
1N3335B	62	200	7	120	5	5	47.1	44.6	660	.090
1N3336B	68	180	8	140	5	5	51.7	49.0	600	.090
1N3337B	75	170	9	150	5	5	56.0	54.0	540	.090
1N3338B	82	150	11	160	5	5	62.2	59.0	490	.090
1N3339B	91	140	15	180	5	5	69.2	65.5	420	.090
1N3340B	100	120	20	200	5	5	76.0	72.0	400	.090
1N3341B	105	120	25	210	5	5	79.8	75.6	380	.095
1N3342B	110	110	30	220	5	5	83.6	79.2	365	.095
1N3343B	120	100	40	240	5	5	91.2	86.4	335	.095
1N3344B	130	95	50	275	5	5	98.8	93.6	310	.095
1N3345B	140	90	60	325	5	5	106.4	100.8	290	.095
1N3346B	150	85	75	400	5	5	114.0	108.0	270	.095
1N3347B	160	80	80	450	5	5	121.6	115.2	250	.095
1N3348B	175	70	85	500	5	5	133.0	126.0	230	.095
1N3349B	180	68	90	525	5	5	136.8	129.6	220	.095
1N3350B	200	65	100	600	5	5	152.0	144.0	200	.100

V_Z @ T_c = 30°C

V_F = 1.5V max @ 10 A on all types.

† Non Suffix V_Z = ±20%

A Suffix V_Z = ±10%

B Suffix V_Z = ±5%

Standard Polarity – Anode to Case

*** Available in JAN and JANTX per MIL-S-1900/358

*V_{R1} – Test Voltage for 5% Tolerance Device, Suffix B

**V_{R2} – Test Voltage for 10% Tolerance Device, Suffix A

No Leakage Specified for 20% Tolerance Device, Non Suffix
Derating Factor Linear above 75°C: 500 mW/°C

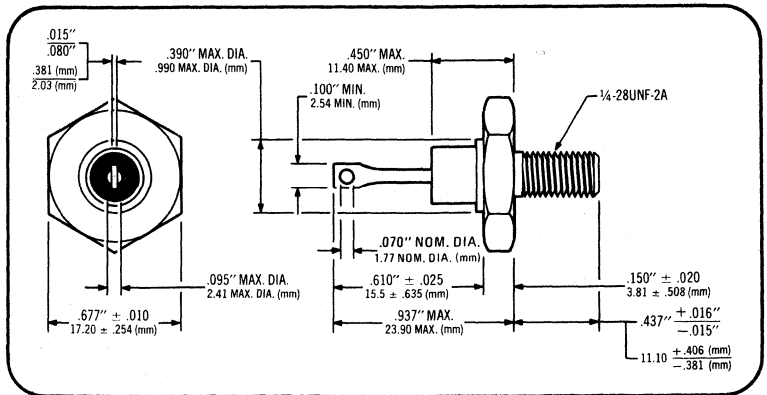
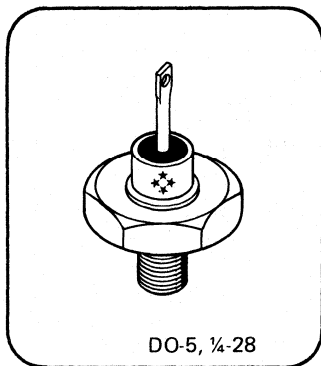

250 mW, Glass, TC (Case DO-7)

JEDEC TYPE NUMBER	ZENER VOLTAGE V_Z VOLTS		TEST CURRENT I_{ZT} mA	MAXIMUM ZENER IMPEDANCE Z_{ZT} @ I_{ZT} Ohms	VOLTAGE TEMPERATURE STABILITY ΔV_{ZT} Max. mV	TEMPERATURE RANGE °C	EFFECTIVE TEMPERATURE COEFFICIENT %/°C
	Min.	Max.					
1N821	5.9	6.5	7.5	15	96	-55 to +100	.01
1N821A	5.9	6.5	7.5	10	96	55 to +100	.01
1N823	5.9	6.5	7.5	15	48	55 to +100	.005
1N823A	5.9	6.5	7.5	10	48	55 to +100	.005
1N825	5.9	6.5	7.5	15	19	55 to +100	.002
1N825A	5.9	6.5	7.5	10	19	55 to +100	.002
1N826	6.2	6.9	7.5	15	20	55 to +100	.002
1N827	5.9	6.5	7.5	15	9	55 to +100	.001
1N827A	5.9	6.5	7.5	10	9	55 to +100	.001
1N828	6.2	6.9	7.5	15	10	55 to +100	.001
1N829	5.9	6.5	7.5	15	5	55 to +100	.0005
1N829A	5.9	6.5	7.5	10	5	55 to +100	.0005
1N3496	5.9	6.5	7.5	15	23	0 to + 75	.005
1N3497	5.9	6.5	7.5	15	9	0 to + 75	.002
1N3498	5.9	6.5	7.5	15	5	0 to + 75	.001
1N3499	5.9	6.5	7.5	15	2	0 to + 75	.0005
1N3500	5.9	6.5	7.5	15	47	0 to + 75	.01

Polarity - Banded End Positive

Available in JAN and JANTXV per MIL-S-19500/159

250 mW, Glass, TC (Case DO-7)

JEDEC TYPE NUMBER	NOMINAL ZENER VOLTAGE V_Z † VOLTS	TEST CURRENT I_{ZT} mA	MAXIMUM ZENER IMPEDANCE Z_{ZT} @ I_{ZT} Ohms	VOLTAGE TEMPERATURE STABILITY ΔV_{ZT} Max. mV	TEMPERATURE RANGE °C	EFFECTIVE TEMPERATURE COEFFICIENT %/°C
1N4765	9.1	0.5	350	68	0 to + 75	0.01
1N4765A	9.1	0.5	350	141	-55 to +100	0.01
1N4766	9.1	0.5	350	34	0 to + 75	0.005
1N4766A	9.1	0.5	350	70	-55 to +100	0.005
1N4767	9.1	0.5	350	14	0 to + 75	0.002
1N4767A	9.1	0.5	350	28	-55 to +100	0.002
1N4768	9.1	0.5	350	7	0 to + 75	0.001
1N4768A	9.1	0.5	350	14	-55 to +100	0.001
1N4769	9.1	0.5	350	3	0 to + 75	0.0005
1N4769A	9.1	0.5	350	7	55 to +100	0.0005
1N4770	9.1	1.0	200	68	0 to + 75	0.01
1N4770A	9.1	1.0	200	141	-55 to +100	0.01
1N4771	9.1	1.0	200	34	0 to + 75	0.005
1N4771A	9.1	1.0	200	70	-55 to +100	0.005
1N4772	9.1	1.0	200	14	0 to + 75	0.002
1N4772A	9.1	1.0	200	28	55 to +100	0.002
1N4773	9.1	1.0	200	7	0 to + 75	0.001
1N4773A	9.1	1.0	200	14	-55 to +100	0.001
1N4774	9.1	1.0	200	3	0 to + 75	0.0005
1N4774A	9.1	1.0	200	7	-55 to +100	0.0005

† $V_Z = \pm 5\%$

Polarity - Banded End Positive

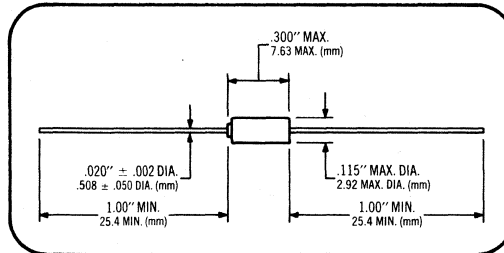
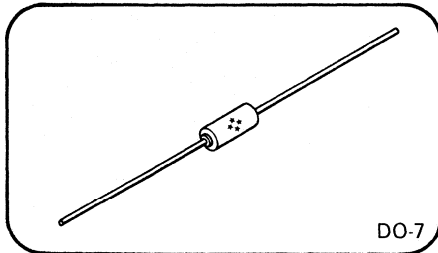

250 mW, Glass, TC (Case DO-7)

JEDEC TYPE NUMBER	NOMINAL ZENER VOLTAGE Vz † VOLTS	TEST CURRENT IzT mA	MAXIMUM ZENER IMPEDANCE ZzT @ IzT Ohms	VOLTAGE TEMPERATURE STABILITY ΔVzT Max.	TEMPERATURE RANGE °C	EFFECTIVE TEMPERATURE COEFFICIENT %/°C
				mV		
1N4775	8.5	0.5	200	64	0 to + 75	0.01
1N4775A	8.5	0.5	200	132	55 to +100	0.01
1N4776	8.5	0.5	200	32	0 to + 75	0.005
1N4776A	8.5	0.5	200	66	55 to +100	0.005
1N4777	8.5	0.5	200	13	0 to + 75	0.002
1N4777A	8.5	0.5	200	26	55 to +100	0.002
1N4778	8.5	0.5	200	6	0 to + 75	0.001
1N4778A	8.5	0.5	200	13	55 to +100	0.001
1N4779	8.5	0.5	200	3	0 to + 75	0.0005
1N4779A	8.5	0.5	200	7	55 to +100	0.0005
1N4780	8.5	1.0	100	64	0 to + 75	0.01
1N4780A	8.5	1.0	100	132	55 to +100	0.01
1N4781	8.5	1.0	100	32	0 to + 75	0.005
1N4781A	8.5	1.0	100	66	55 to +100	0.005
1N4782	8.5	1.0	100	13	0 to + 75	0.002
1N4782A	8.5	1.0	100	26	55 to +100	0.002
1N4783	8.5	1.0	100	6	0 to + 75	0.001
1N4783A	8.5	1.0	100	13	55 to +100	0.001
1N4784	8.5	1.0	100	3	0 to + 75	0.0005
1N4784A	8.5	1.0	100	7	55 to +100	0.0005

†Vz = ±5%

Polarity - Banded End Positive

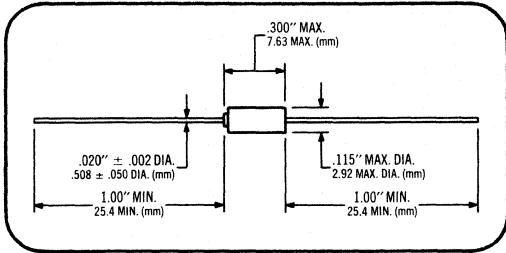
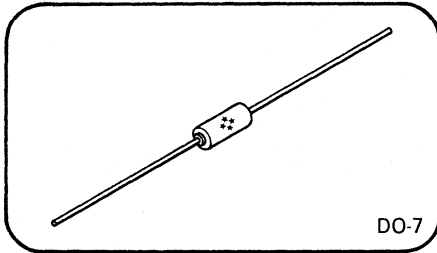

400 mW & 500 mW, Glass, TC (Case DO-7)

JEDEC TYPE NUMBER	ZENER VOLTAGE V _Z		TEST CURRENT I _{ZT} mA	MAXIMUM ZENER IMPEDANCE Z _{ZT} @ I _{ZT} Ohms	VOLTAGE TEMPERATURE STABILITY ΔV _{ZT} Max. mV	TEMPERATURE RANGE °C	EFFECTIVE TEMPERATURE COEFFICIENT %/°C
	Min.	Max.					
1N935	8.55	- 9.45	7.5	20	67	0 to + 75	0.01
1N935A	8.55	- 9.45	7.5	20	139	-55 to +100	0.01
1N935B	8.55	- 9.45	7.5	20	184	-55 to +150	0.01
1N936	8.55	- 9.45	7.5	20	33	0 to + 75	0.005
1N936A	8.55	- 9.45	7.5	20	69	-55 to +100	0.005
1N936B	8.55	- 9.45	7.5	20	92	-55 to +150	0.005
1N937	8.55	- 9.45	7.5	20	13	0 to + 75	0.002
1N937A	8.55	- 9.45	7.5	20	27	55 to +100	0.002
1N937B	8.55	- 9.45	7.5	20	37	-55 to +150	0.002
1N938	8.55	- 9.45	7.5	20	6	0 to + 75	0.001
1N938A	8.55	- 9.45	7.5	20	13	-55 to +100	0.001
1N938B	8.55	- 9.45	7.5	20	18	-55 to +150	0.001
1N939	8.55	- 9.45	7.5	20	3	0 to + 75	0.0005
1N939A	8.55	- 9.45	7.5	20	7	55 to +100	0.0005
1N939B	8.55	- 9.45	7.5	20	9	-55 to +150	0.0005
1N940	8.55	- 9.45	7.5	20	1.3	0 to + 75	0.0002
1N940A	8.55	- 9.45	7.5	20	2.7	-55 to +100	0.0002
1N940B	8.55	- 9.45	7.5	20	3.7	-55 to +150	0.0002

Polarity - Banded End Positive

Available in JAN and JANTXV per MIL-S-19500/156

400 mW & 500 mW, Glass, TC (Case DO-7)

JEDEC TYPE NUMBER	ZENER VOLTAGE V _Z		TEST CURRENT I _{ZT} mA	MAXIMUM ZENER IMPEDANCE Z _{ZT} @ I _{ZT} Ohms	VOLTAGE TEMPERATURE STABILITY ΔV _{ZT} Max. mV	TEMPERATURE RANGE °C	EFFECTIVE TEMPERATURE COEFFICIENT %/°C
	Min.	Max.					
1N941	11.12	- 12.28	7.5	30	88	0 to + 75	.01
1N941A	11.12	- 12.28	7.5	30	181	-55 to +100	.01
1N941B	11.12	- 12.28	7.5	30	239	-55 to +150	.01
1N942	11.12	- 12.28	7.5	30	44	0 to + 75	.005
1N942A	11.12	- 12.28	7.5	30	90	-55 to +100	.005
1N942B	11.12	- 12.28	7.5	30	120	-55 to +150	.005
1N943	11.12	- 12.28	7.5	30	18	0 to + 75	.002
1N943A	11.12	- 12.28	7.5	30	36	-55 to +100	.002
1N943B	11.12	- 12.28	7.5	30	47	-55 to +150	.002
1N944	11.12	- 12.28	7.5	30	9	0 to + 75	.001
1N944A	11.12	- 12.28	7.5	30	18	-55 to +100	.001
1N944B	11.12	- 12.28	7.5	30	24	-55 to +150	.001
1N945	11.12	- 12.28	7.5	30	4	0 to + 75	.0005
1N945A	11.12	- 12.28	7.5	30	9	-55 to +100	.0005
1N945B	11.12	- 12.28	7.5	30	12	-55 to +150	.0005
1N946	11.12	- 12.28	7.5	30	1.8	0 to + 75	.0002
1N946A	11.12	- 12.28	7.5	30	3.6	-55 to +100	.0002
1N946B	11.12	- 12.28	7.5	30	4.7	-55 to +150	.0002

Polarity - Banded End Positive

Available in JAN and JANTXV per MIL-S-19500/157

400 mW & 500 mW, Glass, TC (Case DO-7)

JEDEC TYPE NUMBER	ZENER VOLTAGE V _Z		TEST CURRENT I _{ZT} mA	MAXIMUM ZENER IMPEDANCE Z _{ZT} @ I _{ZT} Ohms	VOLTAGE TEMPERATURE STABILITY ΔV _{ZT} Max. mV	TEMPERATURE RANGE °C	EFFECTIVE TEMPERATURE COEFFICIENT %/°C
	Min.	Max.					
1N3154	8.0	- 8.8	10	15	130	55 to +100	.01
1N3154A	8.0	- 8.8	10	15	172	-55 to +150	.01
1N3155	8.0	- 8.8	10	15	65	55 to +100	.005
1N3155A	8.0	- 8.8	10	15	86	55 to +150	.005
1N3156	8.0	- 8.8	10	15	26	55 to +100	.002
1N3156A	8.0	- 8.8	10	15	34	55 to +150	.002
1N3157	8.0	- 8.8	10	15	13	55 to +100	.001
1N3157A	8.0	- 8.8	10	15	17	55 to +150	.001

Polarity - Banded End Positive

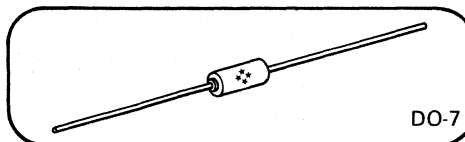

TEMPERATURE COMPENSATED DIODES

3

400 mW & 500 mW, Glass, TC (Case DO-7)

JEDEC TYPE NUMBER	ZENER VOLTAGE V _Z VOLTS		TEST CURRENT I _{ZT} mA	MAXIMUM ZENER IMPEDANCE Z _{ZT} @ I _{ZT} Ohms	EFFECTIVE TEMPERATURE COEFFICIENT %/°C	TEMPERATURE RANGE °C
	Min.	Max.				
1N3779	6.3	6.7	7.5	10	.015	-55 to +100
1N3780	6.3	6.7	7.5	10	.01	-55 to +100
1N3781	6.3	6.7	7.5	10	.005	-55 to +100
1N3782	6.3	6.7	7.5	10	.002	-55 to +100
1N3783	6.3	6.7	7.5	10	.001	-55 to +100
1N3784	6.3	6.7	7.5	10	.0005	-55 to +100

Polarity - Banded End Positive

400 mW & 500 mW, Glass, TC (Case DO-7)

JEDEC TYPE NUMBER	NOMINAL ZENER VOLTAGE V _Z † VOLTS	TEST CURRENT I _{ZT} mA	MAXIMUM ZENER IMPEDANCE Z _{ZT} @ I _{ZT} Ohms	VOLTAGE TEMPERATURE STABILITY ΔV _{ZT} Max. mV	EFFECTIVE TEMPERATURE COEFFICIENT %/°C	TEMPERATURE RANGE °C
1N4295	10.0 ±2%	10.0	20	0 to +246	0 to .012	-55 to +150
1N4295A	10.0 ±1%	10.0	20	0 to +246	0 to .012	-55 to +150
1N4565	6.4	0.5	200	48	.01	0 to +75
1N4565A	6.4	0.5	200	99	.01	-55 to +100
1N4566	6.4	0.5	200	24	.005	0 to +75
1N4566A	6.4	0.5	200	50	.005	-55 to +100
1N4567	6.4	0.5	200	9.6	.002	0 to +75
1N4567A	6.4	0.5	200	20	.002	55 to +100
1N4568	6.4	0.5	200	4.8	.001	0 to +75
1N4568A	6.4	0.5	200	9.9	.001	-55 to +100
1N4569	6.4	0.5	200	2.4	.0005	0 to +75
1N4569A	6.4	0.5	200	5.0	.0005	-55 to +100
1N4570	6.4	1.0	100	48	.01	0 to +75
1N4570A	6.4	1.0	100	99	.01	-55 to +100
1N4571	6.4	1.0	100	24	.005	0 to +75
1N4571A	6.4	1.0	100	50	.005	-55 to +100
1N4572	6.4	1.0	100	9.6	.002	0 to +75
1N4572A	6.4	1.0	100	20	.002	-55 to +100
1N4573	6.4	1.0	100	4.8	.001	0 to +75
1N4573A	6.4	1.0	100	9.9	.001	55 to +100
1N4574	6.4	1.0	100	2.4	.0005	0 to +75
1N4574A	6.4	1.0	100	5.0	.0005	-55 to +100
1N4575	6.4	2.0	50	48	.01	0 to +75
1N4575A	6.4	2.0	50	99	.01	-55 to +100
1N4576	6.4	2.0	50	24	.005	0 to +75
1N4576A	6.4	2.0	50	50	.005	-55 to +100
1N4577	6.4	2.0	50	9.6	.002	0 to +75
1N4577A	6.4	2.0	50	20	.002	55 to +100
1N4578	6.4	2.0	50	4.8	.001	0 to +75
1N4578A	6.4	2.0	50	9.9	.001	-55 to +100
1N4579	6.4	2.0	50	2.4	.0005	0 to +75
1N4579A	6.4	2.0	50	5.0	.0005	-55 to +100
1N4580	6.4	4.0	25	48	.01	0 to +75
1N4580A	6.4	4.0	25	99	.01	-55 to +100
1N4581	6.4	4.0	25	24	.005	0 to +75
1N4581A	6.4	4.0	25	50	.005	-55 to +100
1N4582	6.4	4.0	25	9.6	.002	0 to +75
1N4582A	6.4	4.0	25	20	.002	-55 to +100
1N4583	6.4	4.0	25	4.8	.001	0 to +75
1N4583A	6.4	4.0	25	9.9	.001	-55 to +100
1N4584	6.4	4.0	25	2.4	.0005	0 to +75
1N4584A	6.4	4.0	25	5.0	.0005	-55 to +100

† V_Z = ±5%

Polarity - Banded End Positive

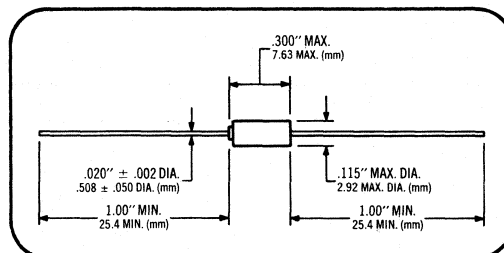
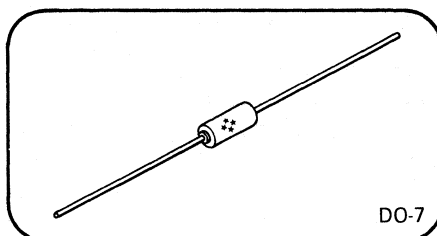

1 WATT, Metal TC (Case DO-13)

JEDEC TYPE NUMBER	ZENER VOLTAGE Vz		TEST CURRENT I _{ZT} mA	MAXIMUM ZENER IMPEDANCE Z _{ZT} @ I _{ZT} Ohms	VOLTAGE TEMPERATURE STABILITY ΔV _{ZT} Max. mV	EFFECTIVE TEMPERATURE COEFFICIENT %/°C	TEMPERATURE RANGE °C
	Min.	Max.					
1N2163	9.0	9.8	10	15	33	.005	0 to + 70
1N2163A	9.2	9.6	10	15	33	.005	0 to + 70
1N2164	9.0	9.8	10	15	85	.005	-55 to +125
1N2164A	9.2	9.6	10	15	85	.005	-55 to +125
1N2165	9.0	9.8	10	15	115	.005	-55 to +185
1N2165A	9.2	9.6	10	15	115	.005	-55 to +185
1N2166	9.0	9.8	10	15	7	.001	0 to + 70
1N2166A	9.2	9.6	10	15	7	.001	0 to + 70
1N2167	9.0	9.8	10	15	17	.001	-55 to +125
1N2167A	9.2	9.6	10	15	17	.001	-55 to +125
1N2168	9.0	9.8	10	15	23	.001	-55 to +185
1N2168A	9.2	9.6	10	15	23	.001	-55 to +185
1N2169	9.0	9.8	10	15	4	.0005	0 to + 70
1N2169A	9.2	9.6	10	15	4	.0005	0 to + 70
1N2170	9.0	9.8	10	15	9	.0005	-55 to +125
1N2170A	9.2	9.6	10	15	9	.0005	-55 to +125
1N2171	9.0	9.8	10	15	12	.0005	-55 to +185
1N2171A	9.2	9.6	10	15	12	.0005	-55 to +185

Standard Polarity - Case Negative
Derating Factor above 25°C: 5 mW/°C

1 WATT, Metal TC (Case DO-13)

JEDEC TYPE NUMBER	NOMINAL ZENER VOLTAGE Vz		TEST CURRENT I _{ZT} mA	MAXIMUM ZENER IMPEDANCE Z _{ZT} @ I _{ZT} Ohms	VOLTAGE TEMPERATURE STABILITY ΔV _{ZT} Max. mV	EFFECTIVE TEMPERATURE COEFFICIENT %/°C	TEMPERATURE RANGE °C
	Min.	Max.					
1N2620	9.3		10	15	70	.01	0 to + 75
1N2620A	9.3		10	15	145	.01	-55 to +100
1N2620B	9.3		10	15	190	.01	-55 to +150
1N2621	9.3		10	15	35	.005	0 to + 75
1N2621A	9.3		10	15	72	.005	-55 to +100
1N2621B	9.3		10	15	95	.005	-55 to +150
1N2622	9.3		10	15	14	.002	0 to + 75
1N2622A	9.3		10	15	29	.002	-55 to +100
1N2622B	9.3		10	15	38	.002	-55 to +150
1N2623	9.3		10	15	7	.001	0 to + 75
1N2623A	9.3		10	15	14	.001	-55 to +100
1N2623B	9.3		10	15	19	.001	-55 to +150
1N2624	9.3		10	15	3.5	.0005	0 to + 75
1N2624A	9.3		10	15	7.0	.0005	-55 to +100
1N2624B	9.3		10	15	9.5	.0005	-55 to +150

Standard Polarity - Case Positive
Derating Factor above 25°C = 5 mW/°C

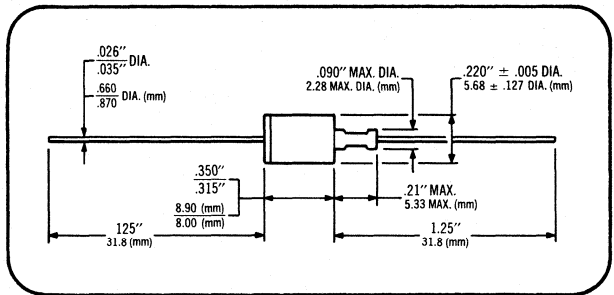
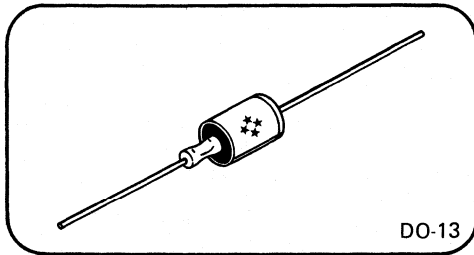

TEMPERATURE COMPENSATED DIODES

1 WATT, Metal TC (Case DO-13)

JEDEC TYPE NUMBER	NOMINAL ZENER VOLTAGE $V_Z \uparrow$ VOLTS	TEST CURRENT I_{ZT} mA	MAXIMUM ZENER IMPEDANCE $Z_{ZT} @ I_{ZT}$ Ohms	VOLTAGE	TEMPERATURE	EFFECTIVE
				TEMPERATURE STABILITY $\Delta V_{ZT} \text{ Max.}$ mV		
1N3580	11.7	7.5	25	88	0 to + 75	.01
1N3580A	11.7	7.5	25	180	-55 to +100	.01
1N3580B	11.7	7.5	25	240	-55 to +150	.01
1N3581	11.7	7.5	25	44	0 to + 75	.005
1N3581A	11.7	7.5	25	90	-55 to +100	.005
1N3581B	11.7	7.5	25	120	-55 to +150	.005
1N3582	11.7	7.5	25	18	0 to + 75	.002
1N3582A	11.7	7.5	25	36	-55 to +100	.002
1N3582B	11.7	7.5	25	48	-55 to +150	.002
1N3583	11.7	7.5	25	9	0 to + 75	.001
1N3583A	11.7	7.5	25	18	-55 to +100	.001
1N3583B	11.7	7.5	25	24	-55 to +150	.001
1N3584	11.7	7.5	25	4.4	0 to + 75	.0005
1N3584A	11.7	7.5	25	9	-55 to +100	.0005
1N3584B	11.7	7.5	25	12	-55 to +150	.0005
1N4296	10.0 $\pm 2\%$	20.0	10	0 to +246	-55 to +150	0 to .012
1N4296A	10.0 $\pm 1\%$	20.0	10	0 to +246	-55 to +150	0 to .012

$\uparrow V_Z = \pm 5\%$

Standard Polarity - Case Positive

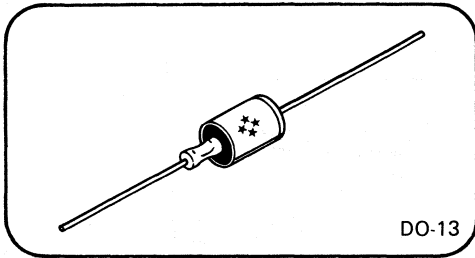

DO-13

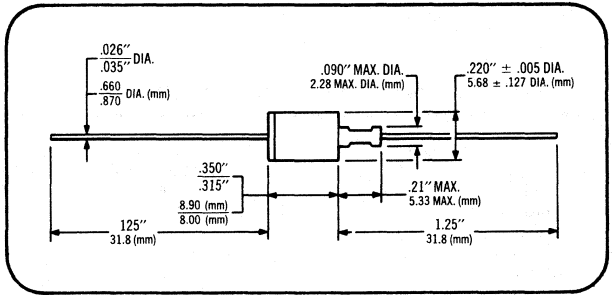

10 WATT, Metal TC (Case DO-4, 10-32)

JEDEC TYPE NUMBER	ZENER VOLTAGE V _Z VOLTS		TEST CURRENT I _{ZT} * mA	MAXIMUM ZENER IMPEDANCE Z _{ZT} @ I _{ZT} Ohms	EFFECTIVE TEMPERATURE COEFFICIENT %/°C	TEMPERATURE RANGE °C
	Min.	Max.				
1N4297	8.36	9.24	200.0	1.4	0.01	0 to + 75
1N4297A	8.36	9.24	200.0	1.4	0.01	-55 to +100
1N4297B	8.36	9.24	200.0	1.4	0.01	-55 to +150
1N4298	8.36	9.24	200.0	1.4	0.005	0 to + 75
1N4298A	8.36	9.24	200.0	1.4	0.005	-55 to +100
1N4298B	8.36	9.24	200.0	1.4	0.005	-55 to +150
1N4299	10.74	11.86	150.0	1.6	0.01	0 to + 75
1N4299A	10.74	11.86	150.0	1.6	0.01	-55 to +100
1N4299B	10.74	11.86	150.0	1.6	0.01	-55 to +150
1N4300	10.74	11.86	150.0	1.6	0.005	0 to + 75
1N4300A	10.74	11.86	150.0	1.6	0.005	-55 to +100
1N4300B	10.74	11.86	150.0	1.6	0.005	-55 to +150

*I_Z (nominal) is shown.

T.C. is guaranteed over current ranges: 150-250 mA for 1N4297, 8;

110-190 mA for 1N4299, 300

Standard Polarity - Case Negative

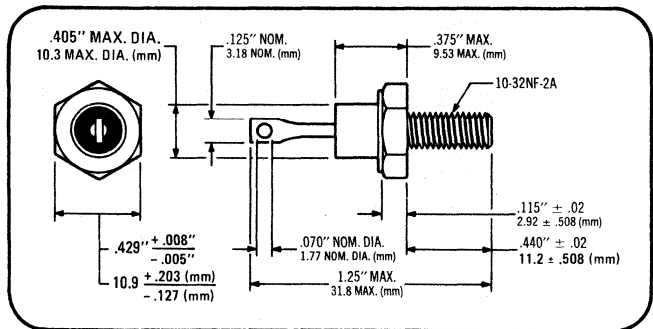
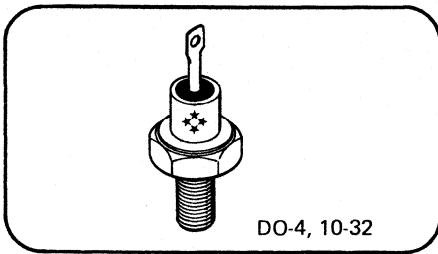

3
TEMPERATURE
COMPENSATED DIODES

50 WATT, Metal TC (Case DO-5, 1/4-28)

JEDEC TYPE NUMBER	ZENER VOLTAGE Vz VOLTS		TEST CURRENT I _{ZT} * mA	MAXIMUM ZENER IMPEDANCE Z _{zT} @ I _{ZT} Ohms	EFFECTIVE TEMPERATURE COEFFICIENT %/°C	TEMPERATURE RANGE °C
	Min.	Max.				
1N4301	8.36	9.24	1000.0	.6	0.01	0 to + 75
1N4301A	8.36	9.24	1000.0	.6	0.01	-55 to +100
1N4301B	8.36	9.24	1000.0	.6	0.01	-55 to +150
1N4302	8.36	9.24	1000.0	.6	0.005	0 to + 75
1N4302A	8.36	9.24	1000.0	.6	0.005	-55 to +100
1N4302B	8.36	9.24	1000.0	.6	0.005	-55 to +150
1N4303	10.74	11.86	750.0	.8	0.01	0 to + 75
1N4303A	10.74	11.86	750.0	.8	0.01	-55 to +100
1N4303B	10.74	11.86	750.0	.8	0.01	-55 to +150
1N4304	10.74	11.86	750.0	.8	0.005	0 to + 75
1N4304A	10.74	11.86	750.0	.8	0.005	-55 to +100
1N4304B	10.74	11.86	750.0	.8	0.005	-55 to +150

*I_Z (nominal) is shown.

T.C. is guaranteed over current ranges: 750-1250 for 1N4301, 2;
550-950 mA for 1N4303,4

Standard Polarity - Case Negative

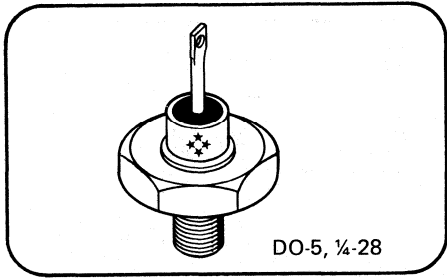

DO-5, 1/4-28

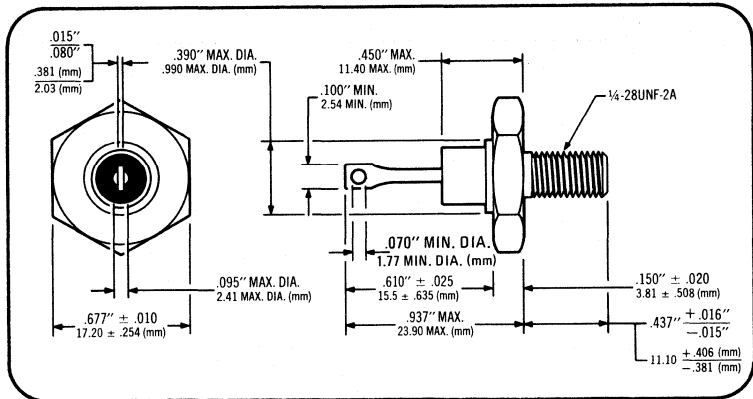

MOLDED TC ASSEMBLIES

JEDEC TYPE NUMBER	NOMINAL ZENER VOLTAGE V _Z †	TEST CURRENT I _{ZT}	MAXIMUM ZENER IMPEDANCE Z _{ZT} @ I _{ZT}	VOLTAGE TEMPERATURE STABILITY -55°C TO +25°C		VOLTAGE TEMPERATURE STABILITY +25°C TO +100°C		EFFECTIVE TEMPERATURE COEFFICIENT %/°C	MAXIMUM POWER DISSIPATION WATTS	CASE NUMBER
				Ohms	mV ΔV _{ZT} Max.	mV ΔV _{ZT} Max.	mV ΔV _{ZT} Max.			
1N429	6.2	7.5	20	50	50	.01	.200	5		
1N1735	6.2	7.5	20	50	50	.01	.200	9		
1N1530	8.4	10.0	14	14	14	.002	.250	10		
1N1530A	8.4	10.0	14	7	7	.001	.250	10		
1N2765	6.8	7.5	20	50	50	.01	1.0	14		
1N2765A	6.8	7.5	20	25	25	.005	1.0	14		
1N2766	13.6	7.5	40	100	100	.01	1.0	14		
1N2766A	13.6	7.5	40	50	50	.005	1.0	14		
1N1736	12.4	7.5	40	100	100	.01	.40	11		
1N1736A	12.4	7.5	40	50	50	.005	.40	11		
1N1737	18.6	7.5	60	150	150	.01	.60	12		
1N1737A	18.6	7.5	60	75	75	.005	.60	12		
1N2767	20.4	7.5	60	150	150	.01	1.0	15		
1N2767A	20.4	7.5	60	75	75	.005	1.0	15		
1N1738	24.8	7.5	80	200	200	.01	.80	18		
1N1738A	24.8	7.5	80	100	100	.005	.80	18		
1N2768	27.2	7.5	80	200	200	.01	1.0	15		
1N2768A	27.2	7.5	80	100	100	.005	1.0	15		
1N1739	31.0	7.5	100	250	250	.01	1.0	18		
1N1739A	31.0	7.5	100	125	125	.005	1.0	18		
1N2769	34.0	7.5	100	250	250	.01	1.0	16		
1N2769A	34.0	7.5	100	125	125	.005	1.0	16		
1N1740	37.2	7.5	120	300	300	.01	1.2	18		
1N1740A	37.2	7.5	120	150	150	.005	1.2	18		
1N2770	40.8	7.5	120	300	300	.01	1.0	16		
1N2770A	40.8	7.5	120	150	150	.005	1.0	16		
1N1741	43.4	7.5	140	350	350	.01	1.4	18		
1N1741A	43.4	7.5	140	175	175	.005	1.4	18		
1N1742	49.6	7.5	160	400	400	.01	1.6	18		
1N1742A	49.6	7.5	160	200	200	.005	1.6	18		
1N3199	8.4	10.0	15	34.0	32.0	.005	.27	17		
1N3200	8.4	10.0	15	20.0	19.0	.003	.27	17		
1N3201	8.4	10.0	15	13.4	12.9	.002	.27	17		
1N3202	8.4	10.0	15	6.7	6.3	.001	.27	17		

†V_Z = ±5%

Polarity - Positive Terminal Indicated

3 TEMPERATURE COMPENSATED DIODES

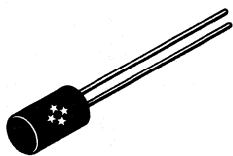

Case 5

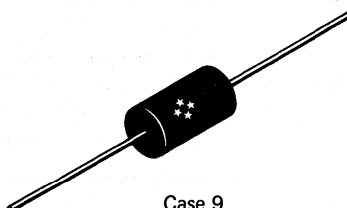
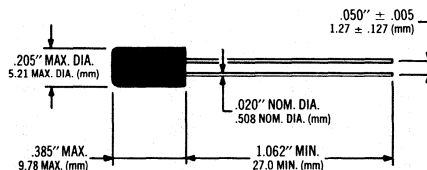

Case 9

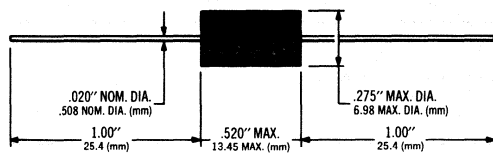

MOLDED TC ASSEMBLIES

JEDEC TYPE NUMBER	NOMINAL ZENER VOLTAGE V_{ZT} VOLTS	TEST CURRENT I_{ZT} mA	MAXIMUM ZENER IMPEDANCE Z_{ZT} @ I_{ZT} Ohms	VOLTAGE TEMPERATURE STABILITY		EFFECTIVE TEMPERATURE COEFFICIENT %/°C	MAXIMUM POWER DISSIPATION WATTS	CASE NUMBER
				- 55°C TO + 25°C ΔV_{ZT} Max.	+ 25°C TO + 100°C ΔV_{ZT} Max.			
1N4057	12.4	10	25	50	46	.005	1.5	18
1N4057A	12.4	10	25	20	19	.002	1.5	18
1N4058	14.6	10	30	58	55	.005	1.5	18
1N4058A	14.6	10	30	23	22	.002	1.5	18
1N4059	16.8	10	30	67	63	.005	1.5	18
1N4059A	16.8	10	30	27	25	.002	1.5	18
1N4060	18.5	10	30	74	69	.005	1.5	18
1N4060A	18.5	10	30	30	28	.002	1.5	18
1N4061	21	10	35	84	79	.005	1.5	18
1N4061A	21	10	35	34	31	.002	1.5	18
1N4062	23	10	40	92	86	.005	1.5	18
1N4062A	23	10	40	37	35	.002	1.5	18
1N4063	27	10	45	108	101	.005	1.5	18
1N4063A	27	10	45	48	41	.002	1.5	18
1N4064	30	10	50	120	113	.005	1.5	18
1N4064A	30	10	50	48	45	.002	1.5	18
1N4065	33	10	55	132	124	.005	1.5	18
1N4065A	33	10	55	53	50	.002	1.5	18
1N4066	37	7.5	80	148	139	.005	1.5	18
1N4066A	37	7.5	80	59	56	.002	1.5	18
1N4067	43	7.5	90	172	161	.005	1.5	18
1N4067A	43	7.5	90	69	65	.002	1.5	18
1N4068	47	7.5	100	188	176	.005	1.5	18
1N4068A	47	7.5	100	75	71	.002	1.5	18
1N4069	51	7.5	110	204	191	.005	2.0	19
1N4069A	51	7.5	110	82	77	.002	2.0	19
1N4070	56	7.5	120	224	210	.005	2.0	19
1N4070A	56	7.5	120	90	84	.002	2.0	19
1N4071	62	7.5	135	248	233	.005	2.0	19
1N4071A	62	7.5	135	99	93	.002	2.0	19
1N4072	68	5.0	230	272	255	.005	2.0	19
1N4072A	68	5.0	230	109	102	.002	2.0	19
1N4073	75	5.0	250	300	281	.005	2.0	19
1N4073A	75	5.0	250	120	113	.002	2.0	19
1N4074	82	5.0	270	328	308	.005	2.0	19
1N4074A	82	5.0	270	131	123	.002	2.0	19
1N4075	87	5.0	290	348	326	.005	2.0	19
1N4075A	87	5.0	290	139	131	.002	2.0	19
1N4076	91	5.0	310	364	341	.005	2.0	19
1N4076A	91	5.0	310	146	137	.002	2.0	19
1N4077	100	5.0	340	400	375	.005	2.0	19
1N4077A	100	5.0	340	160	150	.002	2.0	19
1N4078	105	2.5	700	420	394	.005	2.0	19
1N4078A	105	2.5	700	168	158	.002	2.0	19
1N4079	110	2.5	740	440	413	.005	2.0	19
1N4079A	110	2.5	740	176	165	.002	2.0	19
1N4080	120	2.5	800	480	450	.005	2.0	19
1N4080A	120	2.5	800	192	180	.002	2.0	19
1N4081	130	2.5	840	520	488	.005	2.5	20
1N4081A	130	2.5	840	208	195	.002	2.5	20
1N4082	140	2.5	960	560	525	.005	2.5	20
1N4082A	140	2.5	960	224	210	.002	2.5	20
1N4083	150	2.5	1020	600	563	.005	2.5	20
1N4083A	150	2.5	1020	240	225	.002	2.5	20
1N4084	175	2.5	1150	700	656	.005	2.5	20
1N4084A	175	2.5	1150	280	263	.002	2.5	20
1N4085	200	2.5	1350	800	750	.005	2.5	20
1N4085A	200	2.5	1350	320	300	.002	2.5	20

† $V_Z = \pm 5\%$

Polarity - Banded End Positive

Derating Factor above 25°C - Case 18 - 12mW/°C

Case 19 - 16mW/°C

Case 20 - 20mW/°C

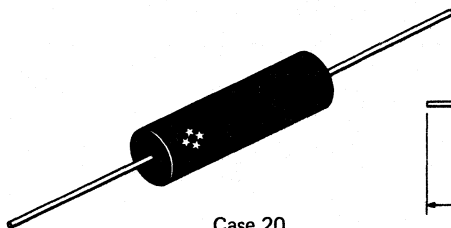

Case 20

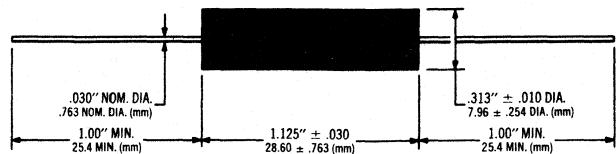

C²R DEFINITIONS AND SPECIFICATIONS

C²R transistors are the latest in new technology for extremely fast NPN power switching transistors. These are designed using a structure called charge-control rings (C²R) that give a voltage rating up to 450 volts at high currents. Forced gain is a minimum of 10 to 20 at up to 15A collector current, a figure most other manufacturers require Darlington configurations to get, and then at only slower speeds. Saturation ($V_{CE(sat)}$) remains below 1.0V at 15A.

C²R provides reliable high-voltage operation with a stable planar epitaxial device.

Another unusual feature of the devices is the great emitter periphery length. This periphery gives high current-carrying capacity with the low saturation voltage and resulting high gain.

The relatively small emitter area for the current-handling capacity results in low output capacitance, and, consequently, high speed. Turn-on time is under 100 nsec.

Switching fundamentals

Because a working knowledge of the switching cycle holds the key to understanding safe operating area (SOA) data, a basic review may prove useful.

We'll start with the switch open, a state that relates to V_{CEO} , V_{CER} and V_{CEX} , then show (Figure 1) what happens when it closes in a resistive circuit. Peak power equals 1/4 maximum voltage times maximum current. These conditions relate to the forward-bias SOA (for example, if you use a transistor rated to switch 400V at 15A, the peak power will be 1500W).

Transistor data sheets graph forward-bias SOA for

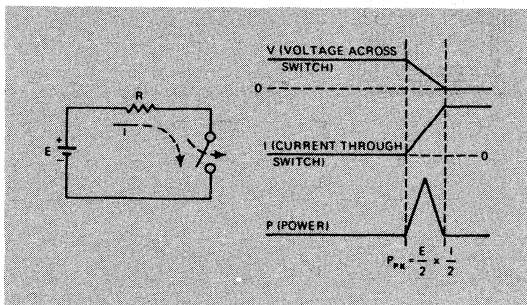

FIGURE 1 — Closing the switch in a resistive circuit creates peak power of $1/4 E_{MAX} I_{MAX}$.

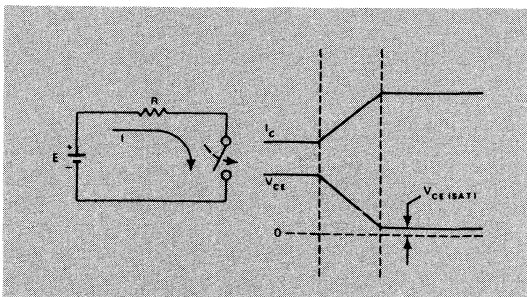

FIGURE 2 — Transistor switching produces the transistor operating conditions depicted here.

time periods such as 1 msec or 10 μ sec. What is actually shown are characteristics that depict the device's energy-handling capabilities for simultaneous voltage and current. For most designs this information serves to define how much energy the transistor can handle under abnormal conditions (such as a short circuit). Usually, transistors can handle significantly more energy in their forward-bias SOA condition than would be demanded under normal switching conditions.

At equilibrium with the switch closed, there is dissipation that depends on $V_{CE(sat)}$, the drop across the conducting transistor at saturation. For most switching transistors the saturation region is not destructive but does contribute to total device dissipation so that it can't be ignored. Figure 2 shows transistor conditions during and after the transition from open to closed circuit.

Now we come to the operating condition that causes the great majority of catastrophic failures in switching transistors — opening the circuit carrying current. Referring to Figure 3 (for resistive switching) we see that this is the reverse of the transition depicted in Figure 1. As in Figure 1, peak power is 1/4 of peak voltage times peak current, but only for resistive switching. If the circuit is inductive, current does not fall until the voltage has reached its peak value, so maximum dissipation will be peak voltage times peak current. In this turn-off region a switching transistor has its lowest energy-handling capability. Reverse biasing of its base-emitter junction causes severe current constriction in the base-emitter region and creates extraordinarily high current density. Simultaneously, as the collector voltage increases, the collector-emitter junction is subjected to an extremely high voltage stress. We now have conditions that permit the destructive avalanche mode or second breakdown (S/B) to occur.

It all sounds bad, but there is a ready remedy. If we use load-line shaping ("snubbing"), we can alleviate this second-breakdown failure state. Figure 4a depicts the principle, using a capacitor to deliberately retard the voltage rise until current has dropped. The effect can be dramatic, with peak power reduced by as much as 100:1.

The slightly more complicated snubbing scheme of Figure 4b gets around the undesirable lengthening of switching-on time that Figure 4a causes. The diode permits the desired retarding of voltage during switching off but allows only a slight lengthening of the switching-on time.

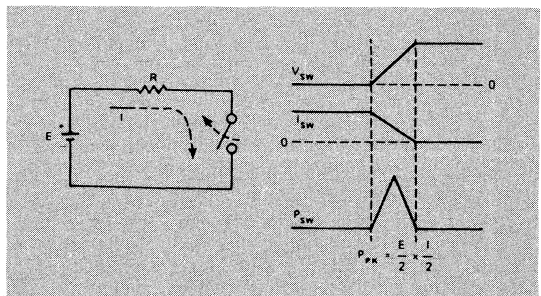

FIGURE 3 — Switching from closed to open in a resistive circuit reverses the action we saw on closing (Figure 1).

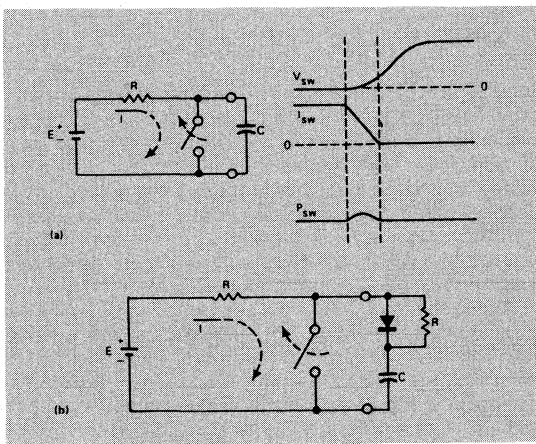
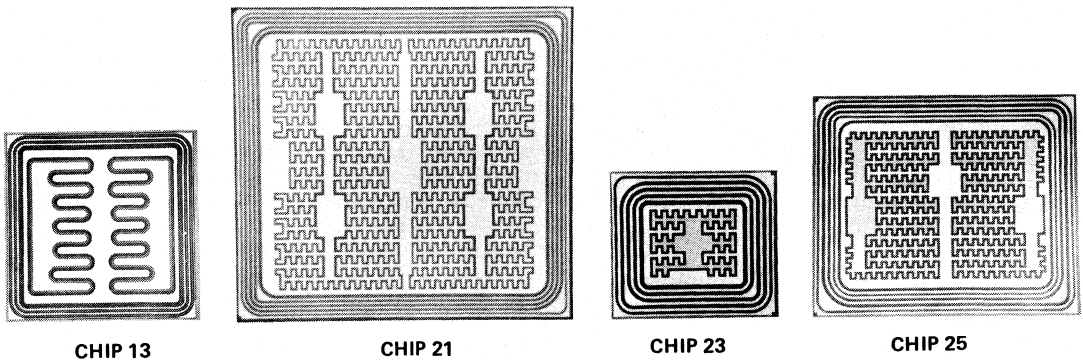

FIGURE 4 — Simple load-line shaping by a capacitor (a) holds back the inductive-circuit voltage rise until current has become low, thereby greatly reducing the peak power. If a diode is added (b), the undesirable retarding of voltage during the switching-ON time is largely avoided.



I_c = 1.0 AMPS

DEVICE TYPE	PACKAGE	BV _{CEO} VOLTS	BV _{CBO} VOLTS	BV _{EBO} VOLTS	P _D @ 100°C WATTS	h _{FE} @		I _c AMPS	V _{CE} VOLTS	V _{CE(sat)} VOLTS	@ I _c		f _T MHz	I _{CBO} @ V _{CB}		DATA SHEET PG. NO.
						Min.	Max.				AMPS	AMPS		μAMP	VOLTS	
2N545	TO-5	50	60	6.0	5.0	15	80	0.5	6.0	1.0	0.5	0.05		15	60	
2N546	TO-5	30	30	6.0	5.0	15	80	0.5	6.0	1.0	0.5	0.05		15	30	
2N547	TO-5	60	60	6.0	5.0	20	80	0.5	6.0	1.0	0.5	0.05	4.0	15	60	
2N548	TO-5	30	30	6.0	5.0	20	80	0.5	6.0	1.0	0.5	0.05	4.0	15	30	
2N549	TO-5	60	60	6.0	5.0	20	80	0.2	6.0	0.6	0.2	0.02	4.0	15	60	
2N550	TO-5	30	30	6.0	5.0	20	80	0.2	6.0	0.6	0.2	0.02	4.0	15	30	
2N1052	TO-5	155	200	6.0	5.0	20	80	0.2	6.0	0.6	0.2	0.02		10	200	
2N1054	TO-5	115	125	6.0	5.0	20		0.2	6.0	0.6	0.2	0.02	8.0	5	125	
2N1055	TO-5	100	100	6.0	3.0	20	80	0.05	6.0	0.6	50mA	5mA	3.0	15	100	
2N1116	TO-5	60	60	6.0	5.0	40	150	0.5	6.0	1.0	0.5	0.05	6.0	15	60	
2N1117	TO-5	60	60	6.0	5.0	40	150	0.2	6.0	0.6	0.2	0.02	4.0	15	60	
2N1252	TO-5	20	30	5.0	4.0	35		0.15	10.0	0.5	0.15	0.015	80.0	10	20	
2N1253	TO-5	20	30	5.0	4.0	45		0.15	10.0	0.5	0.15	0.015	110.0	10	20	
2N1445	TO-5	120	120	8.0	4.0	20	80	0.2	10.0	0.6	0.2	0.04	0.075	10	120	
2N1700	TO-5	40	60	6.0	5.0	20		0.1	4.0	1.0	0.1	0.01	0.4	75	60	
2N1714	TO-5	60	90	6.0	6.0	20	60	0.2	5.0	2.0	0.2	0.02	16.0	1.0	30	
2N1715	TO-5	100	150	6.0	6.0	20	60	0.2	5.0	2.0	0.2	0.02	16.0	1.0	30	
2N1716	TO-5	60	90	6.0	6.0	40	120	0.2	5.0	2.0	0.2	0.02	16.0	1.0	30	
2N1717	TO-5	100	150	6.0	6.0	40	120	0.2	5.0	2.0	0.2	0.02	16.0	1.0	30	
2N1983	TO-5	25	30	5.0	1.0	80	240	5mA	5.0	0.25	5mA	0.5mA	40.0	5.0	30	
2N1984	TO-5	25	30	5.0	1.0	40	120	5mA	5.0	0.25	5mA	0.5mA	40.0	5.0	30	
2N1985	TO-5	25	30	5.0	1.0	20	80	5mA	5.0	0.25	5mA	0.5mA	40.0	0.025	30	
2N2018	TO-111	125	150	6.0	20.0	20	60	0.5	10.0	6.0	1.0	0.1	2.0	100	100	
2N2019	TO-111	140	200	6.0	20.0	20	60	0.5	10.0	6.0	1.0	0.1	2.0	100	100	
2N2150	TO-111	80	125	8.0	30.0	20	60	1.0	5.0	5.0	1.0	1.0	0.1	15		
2N2151	TO-111	80	125	8.0	30.0	40	120	1.0	5.0	5.0	1.0	1.0	0.1	15		
2N2987	TO-5	80	95	7.0	15.0	25	75	0.2	5.0	3.0	0.5	0.05	30.0	0.025	90	
2N2988	TO-5	100	155	7.0	15.0	25	75	0.2	5.0	3.0	0.5	0.05	30.0	0.025	150	
2N2989	TO-5	80	95	7.0	15.0	60	120	0.2	5.0	3.0	0.5	0.05	30.0	0.025	90	
2N2990	TO-5	100	155	7.0	15.0	60	120	0.2	5.0	3.0	0.5	0.05	30.0	0.025	150	
2N3262	TO-39	80	100	4.0	5.0	40		0.5	4.0	0.6	1.0	0.1	100.0	0.1	30	
2N3739	TO-66	300	325	6.0	10.0	40	200	0.1	10.0	2.5	0.250	0.025	10.0	100.0	325	4-27
2N4000	TO-5	80	100	8.0	15.0	30	120	0.5	2.0	0.5	1.0	0.1	40.0	2.0	90	
2N4001	TO-5	100	120	8.0	15.0	40	120	0.5	2.0	0.5	1.0	0.1	40.0	2.0	110	
2N4237	TO-5	40	50	6.0	6.0*	15		1.0	1.0	0.6	1.0	0.1	2.0	0.2mA	50	
2N4238	TO-5	60	80	6.0	6.0*	15		1.0	1.0	0.6	1.0	0.1	2.0	0.1mA	80	
2N4239	TO-5	80	100	6.0	6.0*	15		1.0	1.0	0.6	1.0	0.1	2.0	0.1mA	100	
2N4910	TO-66	40	40	5.0	25.0*	10		1.0	1.0	0.6	1.0	0.1	3.0	0.1mA	40	
2N4911	TO-66	60	60	5.0	25.0*	10		1.0	1.0	0.6	1.0	0.1	3.0	0.1mA	60	
2N4912	TO-66	80	80	5.0	25.0*	10		1.0	1.0	0.6	1.0	0.1	3.0	0.1mA	80	
2N5660	TO-66	200	250	6.0	20.0	40	120	0.5	5.0	0.4	1.0	0.1	20.0	1.0	250	4-61
2N5661	TO-66	300	400	6.0	20.0	25	75	0.5	5.0	0.4	1.0	0.1	20.0	1.0	400	4-61
2N5662	TO-5	200	250	6.0	20.0	40	120	0.5	5.0	0.4	1.0	0.1	20.0	1.0	250	4-63
2N5663	TO-5	300	400	6.0	20.0	25	75	0.5	5.0	0.4	1.0	0.1	20.0	1.0	400	4-63
2N5681	TO-5	100	100	4.0	10.0*	40	150	0.25	2.0	0.6	0.25	0.025	30.0	1.0		
2N5682	TO-5	120	120	4.0	10.0*	40	150	0.25	2.0	0.6	0.25	0.025	30.0	1.0		

*P_D @ T_c = 25°C

I_c = 2.0 AMPS

DEVICE TYPE	PACKAGE	BV _{CEO} VOLTS	BV _{CBO} VOLTS	BV _{EBO} VOLTS	P _D @ 100°C WATTS	h _{FE} @		I _C AMPS	V _{CE} VOLTS	V _{CE(sat)} @ I _C		I _B AMPS	f _T MHz	I _{CBO} @ V _{CB}		DATA SHEET PG. NO.
						Min.	Max.			VOLTS	AMPS			μAMP	VOLTS	
2N4300	TO-5	80	100	8.0	15.0	30 - 120		1.0	2.0	0.3	1.0	0.1	30	10.0	90	
2N4863	TO-5	120	140	8.0	4.0	50 - 150		0.5	5.0	1.5	2.0	0.2	50	0.1	60	4-41
2N4864	TO-66	120	140	8.0	16.0	50 - 150		0.5	5.0	1.5	2.0	0.2	50	0.1	60	4-41
2N5050	TO-66	125	125	6.0	20.0	25 - 100		0.75	5.0	0.3	1.0	0.1	10	5.0mA	125	4-43
2N5051	TO-66	150	150	6.0	20.0	25 - 100		0.75	5.0	0.3	1.0	0.1	10	5.0mA	150	4-43
2N5052	TO-66	200	200	6.0	20.0	25 - 100		0.75	5.0	1.0	0.75	0.1	10			4-43
2N5148	TO-39	80	100	6.0	40.0	30 - 90		1.0	5.0	0.46	1.0	0.1	50	1.0	60	4-49
2N5150	TO-39	80	100	6.0	4.0	70 - 200		1.0	5.0	0.46	1.0	0.1	60	1.0	60	4-49
2N5320	TO-5	75	100	7.0	5.7	30 - 130		0.5	4.0	0.5	0.5	0.05	50	100.0	100	
2N5321	TO-5	50	75	5.0	5.7	40 - 250		0.5	4.0	0.8	0.5	0.05	50	100.0	75	
2N5398	TO-66	60	80	6.0	12.5	70 - 200		1.0	5.0	0.85	2.0	0.2	60			
2N5600	TO-66	80	100	6.0	13.0	30 - 90		1.0	5.0	0.85	2.0	0.2	50	1.0mA	80	
2N5602	TO-66	80	100	6.0	13.0	70 - 200		1.0	5.0	0.85	2.0	0.2	60	1.0mA	100	
2N5604	TO-66	100	120	6.0	13.0	30 - 90		1.0	5.0	0.85	2.0	0.2	50	1.0mA	100	
XGSA1030	TO-5	300	350	7.0	7.5	10		1.0	5.0	0.4	1.0	0.2	30	10.0	280	4-127
XGSA1035	TO-5	350	400	7.0	7.5	10		1.0	5.0	0.4	1.0	0.2	30	10.0	320	4-127
XGSA1040	TO-5	400	450	7.0	7.5	10		1.0	5.0	0.4	1.0	0.2	30	10.0	360	4-127
XGSA1530	TO-5	300	350	7.0	7.5	10		1.5	5.0	0.4	1.5	0.3	30	10.0	280	4-129
XGSA1535	TO-5	350	400	7.0	7.5	10		1.5	5.0	0.4	1.5	0.3	30	10.0	320	4-129
XGSA1540	TO-5	400	450	7.0	7.5	10		1.5	5.0	0.4	1.5	0.3	30	10.0	360	4-129
XGSQ1030	TO-66	300	350	7.0	10.0	10		1.0	5.0	0.4	1.0	0.2	30	10.0	280	4-135
XGSQ1035	TO-66	350	400	7.0	10.0	10		1.0	5.0	0.4	1.0	0.2	30	10.0	320	4-135
XGSQ1040	TO-66	400	450	7.0	10.0	10		1.0	5.0	0.4	1.0	0.2	30	10.0	360	4-135
XGSQ1530	TO-66	300	350	7.0	10.0	10		1.5	5.0	0.4	1.5	0.3	30	10.0	280	4-137
XGSQ1535	TO-66	350	400	7.0	10.0	10		1.5	5.0	0.4	1.5	0.3	30	10.0	320	4-137
XGSQ1540	TO-66	400	450	7.0	10.0	10		1.5	5.0	0.4	1.5	0.3	30	10.0	360	4-137

Ic = 3.0 AMPS

DEVICE TYPE	PACKAGE	V _{CEO} VOLTS	V _{CBO} VOLTS	V _{EBO} VOLTS	P _D @ 100°C WATTS	h _{FE} @ Min.	I _C Max. AMPS	V _{CE} VOLTS	V _{CE(sat)} VOLTS	@ I _C AMPS	I _B AMPS	f _T MHZ	I _{CBO} @ V _{CB} μAMP	DATA SHEET PG. NO.
2N1647	TO-111	80	80	6.0	20.0	15 - 45	0.5	10.0	1.2	1.0	0.1	3.0	100	60
2N1648	TO-111	80	120	6.0	20.0	15 - 45	0.5	10.0	1.2	1.0	0.1	3.0	100	60
2N1649	TO-111	80	80	6.0	20.0	30 - 90	0.5	10.0	1.2	1.0	0.1	3.0	100	60
2N1650	TO-111	80	120	6.0	20.0	30 - 90	0.5	10.0	1.2	1.0	0.1	2.0	100	60
2N2101	TO-61	40	60	10.0	41.0	15 - 60	1.0	15.0	1.2	1.0	0.1		30	60
2N2849	TO-5/S	80	100	5.0	6.7	100 - 300	1.0	1.0	0.4	1.0	0.02	30.0	0.1	80
2N2849-1	TO-5	80	100	5.0	6.7	100 - 300	1.0	1.0	0.4	1.0	0.02	30.0	0.1	80
2N2849-2	TO-59	80	100	5.0	30.0	100 - 300	1.0	1.0	0.4	1.0	0.02	30.0	0.1	80
2N2850	TO-5/S	80	100	5.0	6.7	40 - 120	1.0	1.0	0.25	1.0	0.05	30.0	0.1	80
2N2850-1	TO-5	80	100	5.0	6.7	40 - 120	1.0	1.0	0.25	1.0	0.05	30.0	0.1	80
2N2850-2	TO-59	80	100	5.0	30.0	40 - 120	1.0	1.0	0.25	1.0	0.05	30.0	0.1	80
2N2851	TO-5/S	80	100	5.0	6.7	40 - 120	1.0	1.0	0.4	1.0	0.5	30.0	0.1	80
2N2851-1	TO-5	80	100	5.0	6.7	40 - 120	1.0	1.0	0.4	1.0	0.5	30.0	0.1	80
2N2851-2	TO-59	80	100	5.0	30.0	40 - 120	1.0	1.0	0.4	1.0	0.5	30.0	0.1	80
2N2852	TO-5/S	80	100	5.0	6.7	20 - 60	1.0	1.0	0.4	1.0	0.1	30.0	0.1	80
2N2852-1	TO-5	80	100	5.0	6.7	20 - 60	1.0	1.0	0.4	1.0	0.1	30.0	0.1	80
2N2852-2	TO-59	80	100	5.0	30.0	20 - 60	1.0	1.0	0.4	1.0	0.1	30.0	0.1	40
2N2853	TO-5/S	40	60	5.0	6.7	40	1.0	1.0	1.5	5.0	0.5	30.0	0.1	40
2N2853-1	TO-5	40	60	5.0	6.7	40	1.0	1.0	1.5	5.0	0.5	30.0	0.1	40
2N2853-2	TO-59	40	60	5.0	30.0	40	1.0	1.0	1.5	5.0	0.5	30.0	0.1	40
2N2854	TO-5/S	40	60	5.0	6.7	100 - 300	1.0	1.0	0.4	1.0	0.02	30.0	0.1	40
2N2854-1	TO-5	40	60	5.0	6.7	100 - 300	1.0	1.0	0.4	1.0	0.02	30.0	0.1	40
2N2854-2	TO-59	40	60	5.0	30.0	100 - 300	1.0	1.0	0.4	1.0	0.02	30.0	0.1	40
2N2855	TO-5/S	40	60	5.0	6.7	40 - 120	1.0	1.0	0.4	1.0	0.05	30.0	0.1	40
2N2855-1	TO-5	40	60	5.0	6.7	40 - 120	1.0	1.0	0.4	1.0	0.05	30.0	0.1	40
2N2855-2	TO-59	40	60	5.0	30.0	40 - 120	1.0	1.0	0.4	1.0	0.05	30.0	0.1	40
2N2856	TO-5/S	40	60	5.0	6.7	20 - 60	1.0	1.0	0.4	1.0	0.1	30.0	0.1	40
2N2856-1	TO-5	40	60	5.0	6.7	20 - 60	1.0	1.0	0.4	1.0	0.1	30.0	0.1	40
2N2856-2	TO-59	40	60	5.0	30.0	20 - 60	1.0	1.0	0.4	1.0	0.1	30.0	0.1	40
2N2983	TO-5	80	155	8.0	15.0	20 - 60	1.0	5.0	0.6	1.0	0.1	30.0	10	150
2N2984	TO-5	120	185	8.0	15.0	20 - 60	1.0	5.0	0.6	1.0	0.1	30.0	10	180
2N2985	TO-5	80	155	8.0	15.0	40 - 120	1.0	5.0	0.6	1.0	0.1	30.0	10	150
2N2986	TO-5	120	185	8.0	15.0	40 - 120	1.0	5.0	0.6	1.0	0.1	30.0	10	180
2N3418	TO-5	60	85	8.0	15.0	20 - 60	1.0	2.0	0.25	1.0	0.1	40.0	0.5	80
2N3419	TO-5	80	125	8.0	15.0	20 - 60	1.0	2.0	0.25	1.0	0.1	40.0	0.5	120
2N3420	TO-5	60	85	8.0	15.0	40 - 120	1.0	2.0	0.25	1.0	0.1	40.0	0.5	80
2N3421	TO-5	80	125	8.0	15.0	40 - 120	1.0	2.0	0.25	1.0	0.1	40.0	0.5	120
2N3506	TO-39	40	60	5.0	2.6	40 - 200	1.5	2.0	1.0	1.5	0.15	60.0		4-25
2N3507	TO-39	50	80	5.0	2.6	30 - 150	1.5	2.0	1.0	1.5	0.15	60.0		4-25
2N3675	TO-5	55	90	7.0	5.0	12 - 60	1.0	1.0	0.8	1.0	0.1	1.0	5.0mA	90
2N3676	TO-5	90	90	7.0	5.0	12 - 60	1.0	1.0	0.8	1.0	0.1	1.0	5.0mA	90
2N3738	TO-66	225	250	6.0	10.0	40 - 200	0.1	1.0	25.0	0.25	0.025	10.0	100	250
2N3766	TO-66	60	80	6.0	20.0*	20	1.0	10.0	1.0	0.5	0.05	10.0	0.1mA	80
2N3767	TO-66	80	100	6.0	20.0*	20	1.0	10.0	1.0	0.5	0.05	10.0	0.1mA	100
2N4075	TO-59/ISO	80	100	5.0	17.0	30 - 90	1.0	2.0	0.5	1.0	0.1	30.0	100	100
2N4076	TO-59/ISO	80	100	5.0	17.0	50 - 150	1.0	2.0	0.5	1.0	0.1	30.0	100	100
2N4231	TO-66	40	40	5.0	20.0	25 - 100	1.5	2.0	0.6	1.5	0.15	4.0	50	30
2N4232	TO-66	60	60	5.0	20.0	25 - 100	1.5	2.0	0.6	1.5	0.15	4.0	50	40
2N4233	TO-66	80	80	5.0	20.0	25 - 100	1.5	2.0	0.6	1.5	0.15	4.0	50	60
2N4877	TO-5	60	70	5.0	5.7	20 - 100	2.0	1.0	1.0	0.4	0.4	30.0	100	70
2N5074	TO-59/ISO	200	200	6.0	40.0	30 - 110	0.5	5.0	2.0	3.0	0.3	40.0	0.25	200
2N5075	TO-59/ISO	200	200	6.0	40.0	90 - 250	0.5	5.0	2.0	3.0	0.3	40.0	0.25	200
2N5076	TO-59/ISO	250	250	6.0	40.0	30 - 110	0.5	5.0	2.0	3.0	0.3	40.0	0.25	200
2N5077	TO-59/ISO	250	250	6.0	40.0	90 - 250	0.5	5.0	2.0	3.0	0.3	40.0	0.25	200
2N5202	TO-66	75	100	6.0	2.0	10 - 100	4.0	1.2	1.2	4.0	0.4	60.0	10.0mA	100
2N5334	TO-39	60	60	8.0	3.4	30 - 150	1.0	2.0	0.7	2.0	0.2	40.0	5.0	60
2N5335	TO-39	80	80	8.0	3.4	15	2.0	2.0	0.7	2.0	0.2	40.0	5.0	80
2N5664	TO-66	200	250	6.0	30.0	40 - 120	1.0	5.0	0.4	3.0	0.3	20.0	1000	200
2N5665	TO-66	300	400	6.0	30.0	25 - 75	1.0	5.0	0.4	3.0	0.6	20.0	1000	300
2N5666	TO-5	200	250	6.0	15.0	40 - 120	1.0	5.0	0.4	3.0	0.3	20.0	1000	250
2N5667	TO-5	300	400	6.0	15.0	25 - 75	1.0	5.0	0.4	3.0	0.6	20.0	1000	400
XGS7001	TO-39	30	50	5.0	2.9	20	2.0	2.0	1.0	1.0	0.1	120.0	10	30
XGS7002	TO-39	60	70	5.0	2.9	15	2.0	2.0	1.0	1.0	0.1	120.0	10	40V

*P_D @ T_c = 25°C Available in JAN and JANTX (V)

4

NPN SWITCHING TRANSISTORS

I_c = 5.0 AMPS

DEVICE TYPE	PACKAGE	BV _{CEO} VOLTS	BV _{CBO} VOLTS	BV _{ERO} VOLTS	P _o @ 100°C WATTS	h _{FE} @		I _c AMPS	V _{CE} VOLTS	V _{CE(sat)} @ I _c		I _B AMPS	f _T MHz	I _{CBO} @ V _{CB}		DATA SHEET PG. NO.
						Min.	Max.			VOLTS	AMPS			μAMP	VOLTS	
2N1208	TO-61	60	60	10.0	49.0	15	2.0	2.0	12.0	1.4	2.0	0.25	3.0	10.0mA	60	
2N1209	TO-61	45	45	5.0	49.0	20 - 80	2.0	2.0	12.0	1.4	2.0	0.25	3.0	20.0mA	45	
2N1212	TO-61	60	60	10.0	49.0	12 - 36	1.0	15.0	15.0	1.2	1.0	0.20	3.0	10.0mA	60	
2N1616	TO-61	60	60	8.0	30.0	15 - 75	2.0	2.0	12.0	1.4	2.0	0.25	3.0	1.0mA	60	
2N1617	TO-61	80	80	8.0	30.0	15 - 75	2.0	2.0	12.0	2.0	2.0	0.25	3.0	1.0mA	80	
2N1618	TO-61	100	100	8.0	30.0	15 - 75	2.0	2.0	12.0	2.0	2.0	0.25	3.0	1.0mA	100	
2N1702	TO-3	40	60	6.0	43.0	15 - 60	0.8	4.0	1.0	1.0	0.8	0.015	0.3	200	60	
2N1724	TO-61	80	120	10.0	50.0	20 - 90	2.0	15.0	15.0	1.0	2.0	0.2	10	0.5mA	30	
2N1724A	TO-61	120	180	10.0	50.0	30 - 90	2.0	15.0	15.0	0.6	2.0	0.2	10	0.5mA	30	
2N1725	TO-61	80	120	10.0	50.0	50 - 150	2.0	15.0	1.0	1.0	2.0	0.2	10	0.5mA	30	
2N2632	TO-59	60	90	8.0	20.0	40 - 120	1.0	2.0	2.0	0.25	1.0	0.1	20	0.1	60	
2N2633	TO-59	80	120	8.0	20.0	40 - 120	1.0	2.0	2.0	0.25	1.0	0.1	20	0.1	60	
2N2634	TO-59	100	150	8.0	20.0	40 - 120	1.0	2.0	2.0	0.25	1.0	0.1	20	0.1	60	
2N2657	TO-5	60	80	7.0	4.0	40 - 120	1.0	2.0	2.0	0.5	1.0	0.1	20	0.1	60	
2N2658	TO-5	80	100	7.0	4.0	40 - 120	1.0	2.0	2.0	0.5	1.0	0.1	20	0.1	60	
2N2877	TO-111	60	80	8.0	30.0	20 - 60	1.0	2.0	2.0	0.25	1.0	0.1	30	0.1	60	4-21
2N2878	TO-111	60	80	8.0	30.0	40 - 120	1.0	2.0	2.0	0.25	1.0	0.1	50	0.1	60	4-21
2N2879	TO-111	80	100	8.0	30.0	20 - 60	1.0	2.0	2.0	0.25	1.0	0.1	30	0.1	60	4-21
2N2880	TO-111	80	100	8.0	30.0	40 - 120	1.0	2.0	2.0	0.25	1.0	0.1	50	0.1	60	4-21
2N2890	TO-5	80	100	5.0	3.0	30 - 90	1.0	2.0	2.0	0.5	1.0	0.1	30	0.1	60	
2N2891	TO-5	80	100	5.0	3.0	50 - 150	1.0	2.0	2.0	0.5	1.0	0.1	30	0.1	60	
2N2892	TO-59	80	100	5.0	17.0	30 - 90	1.0	2.0	2.0	0.5	1.0	0.1	30	0.1	60	
2N2893	TO-59	80	100	5.0	17.0	50 - 150	1.0	2.0	2.0	0.5	1.0	0.1	30	0.1	60	
2N3226	TO-3	35	35	6.0	43.0	20 - 50	2.0	3.0	1.0	1.0	2.0	0.2	0.03	0.2	35	
2N3469	TO-5	25	35	7.0	4.0	100	1.0	1.0	1.0	0.5	1.0	0.1	40	0.1	35	
2N3744	TO-111/Iso	40	60	7.0	30.0	20 - 60	1.0	5.0	5.0	0.25	1.0	0.1	30	0.1	30	
2N3745	TO-111/Iso	60	80	8.0	30.0	20 - 60	1.0	5.0	5.0	0.25	1.0	0.1	30	0.1	60	
2N3746	TO-111/Iso	80	100	8.0	30.0	20 - 60	1.0	5.0	5.0	0.25	1.0	0.1	30	0.1	60	
2N3747	TO-111/Iso	40	60	7.0	30.0	40 - 120	1.0	5.0	5.0	0.25	1.0	0.1	40	0.1	30	
2N3748	TO-111/Iso	60	80	8.0	30.0	40 - 120	1.0	5.0	5.0	0.25	1.0	0.1	40	0.1	60	
2N3749	TO-111/Iso	80	100	8.0	30.0	40 - 120	1.0	5.0	5.0	0.25	1.0	0.1	40	0.1	60	
2N3750	TO-111/Iso	40	60	7.0	30.0	100 - 300	1.0	5.0	5.0	0.25	1.0	0.1	50	0.1	30	
2N3751	TO-111/Iso	60	80	8.0	30.0	100 - 300	1.0	5.0	5.0	0.25	1.0	0.1	50	0.1	60	
2N3752	TO-111/Iso	80	100	8.0	30.0	100 - 300	1.0	5.0	5.0	0.25	1.0	0.1	50	0.1	60	
2N3852	TO-59	40	60	5.0	30.0	50 - 150	1.0	1.0	1.0	0.25	1.0	0.05	20	0.1	40	
2N3853	TO-59	40	60	5.0	30.0	30 - 90	1.0	1.0	1.0	0.25	1.0	0.1	20	0.1	40	
2N3996	TO-111/Iso	80	100	8.0	30.0	40 - 120	1.0	2.0	2.0	0.25	1.0	0.1	40	5.0	90	4-29
2N3997	TO-111/Iso	80	100	8.0	30.0	80 - 240	1.0	2.0	2.0	0.25	1.0	0.1	40	5.0	90	4-29
2N3998	TO-111	80	100	8.0	30.0	40 - 120	1.0	2.0	2.0	0.25	1.0	0.1	40	5.0	90	4-29
2N3999	TO-111	80	100	8.0	30.0	80 - 240	1.0	2.0	2.0	0.25	1.0	0.1	40	5.0	90	4-29
2N4111	TO-3	60	100	8.0	30.0	40 - 120	2.0	5.0	1.5	5.0	0.5	0.5	50	10	90	
2N4112	TO-3	60	100	8.0	30.0	100 - 300	2.0	5.0	1.5	5.0	0.5	0.5	60	10	50	
2N4113	TO-3	80	120	8.0	30.0	40 - 120	2.0	5.0	1.5	5.0	0.5	0.5	50	10	60	
2N4114	TO-3	80	120	8.0	30.0	100 - 300	2.0	5.0	1.5	5.0	0.5	0.5	60	10	60	
2N4115	TO-59/Iso	80	120	8.0	37.0	40 - 120	2.0	5.0	1.5	5.0	0.5	0.5	50	10	120	
2N4116	TO-59/Iso	80	120	8.0	37.0	100 - 300	2.0	5.0	1.5	5.0	0.5	0.5	70	10	120	

Ic = 5.0 AMPS CONTINUED

DEVICE TYPE	PACKAGE	BV _{CEO} VOLTS	BV _{CBO} VOLTS	BV _{EBO} VOLTS	P _D @ 100°C WATTS	h _{FE} @		I _C MAX. AMPS	V _{CE} VOLTS	V _{CE(sat)} @ I _C		I _B AMPS	f _T MHZ	I _{CBO} @ V _{CB}		DATA SHEET PG. NO.
						Min.	Max.			VOLTS	AMPS			μAMP	VOLTS	
2N4150	TO-5	80	100	5.0	5.0	40 - 120	5.0	5.0	0.6	5.0	0.5	15	0.1	60	4-37	
2N4240	TO-66	300	500	6.0	20.0	10 - 100	0.75	2.0	1.0	0.75	0.075	15	2.0mA	450	4-39	
2N4395	TO-3	40	60	4.0	50.0	50	2.0	1.0	0.8	4.5	0.8	4.0	100	60		
2N4396	TO-3	60	80	4.0	50.0	50	2.0	1.0	0.8	4.5	0.8	4.0	100	80		
2N4913	TO-3	40	40	5.0	87.5*	25 - 100	2.5	2.0	1.0	2.5	0.25	4.0	1.0mA	40		
2N4914	TO-3	60	60	5.0	87.5*	25 - 100	2.5	2.0	1.0	2.5	0.25	4.0	1.0mA	60		
2N4915	TO-3	80	80	5.0	87.5*	25 - 100	2.5	2.0	1.0	2.5	0.25	4.0	1.0mA	80		
2N5152	TO-39	80	100	6.0	6.0	30 - 90	2.5	5.0	1.5	5.0	0.5	60	1.0	60		
2N5154	TO-39	80	100	6.0	6.0	70 - 200	2.5	5.0	1.5	5.0	0.5	70	1.0	60		
2N5237	TO-5	120	150	5.0	5.0	40 - 120	5.0	5.0	0.6	5.0	0.5	25	1.0	60	4-53	
2N5239	TO-3	225	300	6.0	57.0	20	2.0	10.0	0.9	5.0	0.5	5.0	4.0mA	300		
2N5336	TO-39	80	80	6.0	3.4	30 - 120	2.0	2.0	0.7	2.0	0.2	30	10	80		
2N5337	TO-39	80	80	6.0	3.4	60 - 240	2.0	2.0	0.7	2.0	0.2	30	10	80		
2N5338	TO-39	100	100	6.0	3.4	30 - 120	2.0	2.0	0.7	2.0	0.2	30	10	100		
2N5339	TO-39	100	100	6.0	3.4	60 - 240	2.0	2.0	0.7	2.0	0.2	30	10	100		
2N5487	TO-5/S	80	120	8.0	15.0	100 - 300	1.0	2.0	0.25	1.0	0.1	40				
2N5487-1	TO-5	80	120	8.0	15.0	100 - 300	1.0	2.0	0.25	1.0	0.1	40				
2N5488	TO-5/S	100	150	8.0	15.0	40 - 120	1.0	2.0	0.25	1.0	0.1	40				
2N5488-1	TO-5	100	150	8.0	15.0	40 - 120	1.0	2.0	0.25	1.0	0.1	40				
2N5541	TO-5	130	175	8.0	5.0	30 - 90	5.0	5.0	1.5	5.0	0.5	20	0.5	175	4-59	
2N5606	TO-66	60	80	6.0	14.0	70 - 200	2.5	5.0	1.5	5.0	0.5	70	1.0mA	80		
2N5608	TO-66	80	100	6.0	14.0	30 - 90	2.5	5.0	1.5	5.0	0.5	60	1.0mA	100		
2N5610	TO-66	80	100	6.0	14.0	70 - 200	2.5	5.0	1.5	5.0	0.5	70	1.0mA	100		
2N5612	TO-66	100	120	6.0	14.0	30 - 90	2.5	5.0	1.5	5.0	0.5	60	1.0mA	120		
2N5729	TO-5	80	100	5.0	6.7	30 - 300	2.0	2.0	1.5	5.0	0.5	30	1.0mA	100		
2N6233	TO-66	225	250	6.0	28.6	25 - 125	1.0	5.0	0.5	1.0	0.1	20	0.1mA	250	4-81	
2N6234	TO-66	275	300	6.0	28.6	25 - 125	1.0	5.0	0.5	1.0	0.1	20	0.1mA	300	4-81	
2N6235	TO-66	325	350	6.0	28.6	25 - 125	1.0	5.0	0.5	1.0	0.1	20	0.1mA	350	4-81	
GSTU4030	TO-3	300	350	7.0	62.5	10	4.0	5.0	0.8	4.0	0.8	25	1000	280	4-115	
GSTU4035	TO-3	350	400	7.0	62.5	10	4.0	5.0	0.8	4.0	0.8	25	1000	320	4-115	
GSTU4040	TO-3	400	450	7.0	62.5	10	4.0	5.0	0.8	4.0	0.8	25	1000	360	4-115	
XGSA3030	TO-5	300	350	8.0	10.0	10	3.0	5.0	1.0	3.0	0.6	25	250	280	4-131	
XGSA3035	TO-5	350	400	8.0	10.0	10	3.0	5.0	1.0	3.0	0.6	25	250	320	4-131	
XGSA3040	TO-5	400	450	8.0	10.0	10	3.0	5.0	1.0	3.0	0.6	25	250	360	4-131	
XGSQ3030	TO-66	300	350	8.0	15.0	10	3.0	5.0	0.8	3.0	0.6	25	250	280	4-139	
XGSQ3035	TO-66	350	400	8.0	15.0	10	3.0	5.0	0.8	3.0	0.6	25	250	320	4-139	
XGSQ3040	TO-66	400	450	8.0	15.0	10	3.0	5.0	0.8	3.0	0.6	25	250	360	4-139	
XGSR3030	TO-3	300	350	8.0	75.0	10	3.0	5.0	0.8	3.0	0.6	25	250	280	4-146	
XGSR3035	TO-3	350	400	8.0	75.0	10	3.0	5.0	0.8	3.0	0.6	25	250	320	4-146	
XGSR3040	TO-3	400	450	7.0	75.0	10	3.0	5.0	0.8	3.0	0.6	25	250	360	4-146	

*P_D @ T_C = 25°C

Available in JAN and JANTX(V) per MIL-S-19500/394.

4

NPN SWITCHING TRANSISTORS

I_c = 7.0 AMPS

DEVICE TYPE	PACKAGE	BV _{CEO} VOLTS	BV _{CBO} VOLTS	BV _{EBO} VOLTS	P ₀ @ 100°C WATTS	h _{FE} @		I _c AMPS	V _{CE} VOLTS	V _{CE(sat)} @ I _c		I _B AMPS	f _T MHz	I _{CBO} @ V _{CB}		DATA SHEET PG. NO.
						Min.	Max.			VOLTS	AMPS			μAMP	VOLTS	
2N3878	TO-66	50	120	7.0	20.0	8	100	4.0	2.0	2.0	4.0	0.5	40.0			
2N3879	TO-66	75	120	7.0	20.0	12	100	4.0	2.0	1.2	4.0	0.4	40.0			
2N5346	TO-59/Iso	80	80	6.0	34.0	30	120	2.0	2.0	0.7	2.0	0.2	30.0	10	80	
2N5347	TO-59/Iso	80	80	6.0	34.0	60	240	2.0	2.0	0.7	2.0	0.2	30.0	10	80	
2N5348	TO-59/Iso	100	100	6.0	34.0	30	120	2.0	2.0	0.7	2.0	0.2	30.0	10	100	
2N5349	TO-59/Iso	100	100	6.0	23.0	60	240	2.0	2.0	0.7	2.0	0.2	30.0	10	100	
2N5427	TO-66	80	80	6.0	23.0	30	120	2.0	2.0	0.7	2.0	0.2	30.0	10	80	
2N5428	TO-66	80	80	6.0	23.0	60	240	2.0	2.0	0.7	2.0	0.2	30.0	10	80	
2N5429	TO-66	100	100	6.0	23.0	30	120	2.0	2.0	0.7	2.0	0.2	30.0	10	100	
2N5430	TO-66	100	100	6.0	23.0	60	240	2.0	2.0	0.7	2.0	0.2	30.0	10	100	
2N5477	TO-59	80	80	6.0	35.0	30	120	2.0	2.0	0.7	2.0	0.2	30.0	10	80	
2N5478	TO-59	80	80	6.0	35.0	60	240	2.0	2.0	0.7	2.0	0.2	30.0	10	80	
2N5479	TO-59	100	100	6.0	35.0	30	120	2.0	2.0	1.2	7.0	0.7	30.0	10	100	
2N5480	TO-59	100	100	6.0	35.0	60	240	2.0	2.0	1.2	7.0	0.7	30.0	10	100	
2N6077	TO-66	275	300	6.0	25.0	12	70	1.2	1.0	0.5	1.2	0.2	1.0	5.0mA	250	4-75
2N6078	TO-66	250	275	6.0	25.0	12	70	1.2	1.0	0.5	1.2	0.2	1.0	50	250	4-75
2N6079	TO-66	350	375	9.0	25.0	12	50	1.2	1.0	0.5	1.2	0.2	1.0	500	350	4-77
GSTU6030	TO-3	300	350	7.0	62.5	10		6.0	5.0	0.8	6.0	1.2	25.0	500	280	4-117
GSTU6035	TO-3	350	400	7.0	62.5	10		6.0	5.0	0.8	6.0	1.2	25.0	500	320	4-117
GSTU6040	TO-3	400	450	7.0	62.5	10		6.0	5.0	0.8	6.0	1.2	25.0	500	360	4-117
XGSA5030	TO-5	300	350	8.0	10.0	10		5.0	5.0	1.0	1.0	5.0	25.0	250	280	4-133
XGSA5035	TO-5	350	400	8.0	10.0	10		5.0	5.0	1.0	1.0	5.0	25.0	250	320	4-133
XGSA5040	TO-5	400	450	8.0	10.0	10		5.0	5.0	0.8	1.0	5.0	25.0	250	360	4-133
XGSQ5030	TO-66	300	350	8.0	15.0	10		5.0	5.0	0.8	5.0	1.0	25.0	250	280	4-141
XGSQ5035	TO-66	350	400	8.0	15.0	10		5.0	5.0	0.8	5.0	1.0	25.0	250	320	4-141
XGSQ5040	TO-66	400	450	8.0	15.0	10		5.0	5.0	0.8	5.0	1.0	25.0	250	360	4-141
XGSR5030	TO-3	300	350	8.0	75.0	10		5.0	5.0	0.8	5.0	1.0	25.0	250	280	4-148
XGSR5035	TO-3	350	400	8.0	75.0	10		5.0	5.0	0.8	5.0	1.0	25.0	250	320	4-148
XGSR5040	TO-3	400	450	8.0	75.0	10		5.0	5.0	0.8	5.0	1.0	25.0	250	360	4-148

I_c = 7.5 AMPS

DEVICE TYPE	PACKAGE	BV _{CEO} VOLTS	BV _{CBO} VOLTS	BV _{EBO} VOLTS	P ₀ @ 100°C WATTS	h _{FE} @		I _c AMPS	V _{CE} VOLTS	V _{CE(sat)} @ I _c		I _B AMPS	f _T MHz	I _{CBO} @ V _{CB}		DATA SHEET PG. NO.
						Min.	Max.			VOLTS	AMPS			μAMP	VOLTS	
2N1616A	TO-61	60	60	8.0	53	20	60	2.0	4.0	1.0	2.0	0.2	3.0	200	60	
2N1617A	TO-61	70	80	8.0	53	20	60	2.0	4.0	1.0	2.0	0.2	3.0	200	80	
2N1618A	TO-61	80	100	8.0	53	20	60	2.0	4.0	1.0	2.0	0.2	3.0	200	100	
2N5387	TO-61	200	200	10.0	100	25	100	2.0	5.0	2.2	7.0	1.4	15	1.0mA	180	4-55
2N5388	TO-61	250	250	10.0	100	25	100	2.0	5.0	2.2	7.0	1.4	15	1.0mA	225	4-55
2N5389	TO-61	300	300	10.0	100	25	100	2.0	5.0	2.2	7.0	1.4	15	1.0mA	270	4-57

Ic = 10 AMPS

DEVICE TYPE	PACKAGE	BV _{CEO} VOLTS	BV _{CBO} VOLTS	BV _{EBO} VOLTS	P _D @ 100°C WATTS	h _{FE} @		I _C AMPS	V _{CE} VOLTS	V _{CE(sat)} VOLTS	I _C @ AMPS	I _B AMPS	f _T MHZ	I _{CBO} μAMP	V _{CB} VOLTS	DATA SHEET
						Min.	Max.									PG. NO.
2N2811	TO-61	60	80	8.0	40.0	20 - 60	5.0	5.0	0.5	5.0	0.5	15	0.1	60		
2N2812	TO-61	60	80	8.0	40.0	40 - 120	5.0	5.0	0.5	5.0	0.5	15	0.1	60		
2N2813	TO-61	80	120	8.0	40.0	20 - 60	5.0	5.0	0.5	5.0	0.5	15	0.1	60		
2N2814	TO-61	80	120	8.0	40.0	40 - 120	5.0	5.0	0.5	5.0	0.5	15	0.1	60		
2N4070	TO-3	100	120	8.0	65.0	40 - 120	5.0	5.0	1.5	10.0	1.0	20	0.1	60	4-33	
2N4071	TO-3	150	200	8.0	65.0	40 - 120	5.0	5.0	1.5	10.0	1.0	20	0.1	100	4-35	
2N4301	TO-61	80	100	8.0	50.0	30 - 120	5.0	4.0	0.4	5.0	0.5	40	10.0	90		
2N5218	TO-61	200	220	8.0	50.0	15 - 120	5.0	5.0	0.6	5.0	0.5	40	0.5	100	4-51	
2N5288	TO-61/Iso	100	120	6.0	66.7	30 - 90	5.5	5.0	1.5	10.0	1.0	30	1.0	80		
2N5289	TO-61/Iso	100	120	6.0	66.7	70 - 200	5.0	5.0	1.5	10.0	1.0	40	1.0	80		
2N5313	TO-61	80	80	6.0	50.0	30 - 90	10.0	5.0	1.5	10.0	1.0	30	10	80		
2N5315	TO-61	100	100	6.0	50.0	30 - 90	10.0	5.0	1.5	10.0	1.0	30	10	80		
2N5317	TO-61/Iso	80	80	6.0	50.0	30 - 90	10.0	5.0	1.5	10.0	1.0	30	10	80		
2N5319	TO-61/Iso	100	100	6.0	50.0	30 - 90	10.0	5.0	1.5	10.0	1.0	30	10	80		
2N5412	TO-61	60	80	7.0	50.0	10 - 160	2.0	1.5	1.5	15.0	3.0	60				
2N5542	TO-61	130	175	8.0	50.0	20 - 60	5.0	5.0	1.0	5.0	0.5	20	0.5	175	4-59	
2N5552	TO-5/S	80	120	7.0	15.0	50 - 150	5.0	2.0	0.5	5.0	0.5	30				
2N5552-1	TO-5	80	120	7.0	15.0	50 - 150	5.0	2.0	0.5	5.0	0.5	30				
2N5658	TO-59	80	120	7.0	30.0	50 - 150	5.0	5.0	1.0	10.0	1.0	30	0.2	120		
2N5659	TO-111/Iso	80	120	7.0	30.0	50 - 150	5.0	5.0	1.0	10.0	1.0	30	0.2	120		
2N5730	TO-59/Iso	80	100	5.0	30.0	30 - 300	2.0	2.0	1.2	5.0	0.5	30	1.0mA	100		
2N5854	TO-61/Iso	80	100	6.0	66.0	30 - 90	5.0	5.0	1.5	10.0	1.0	20	500	100		
2N6232	TO-5	100	140	7.0	15.0	25 - 100	5.0	2.0	1.4	10.0	1.0	30	0.2	140	4-79	
GSDB10008	TO-5	80	100	7.0	1.5	20	10	5.0	1.0	10	1.0	50	1.0	80	4-104	
GSTU8035	TO-3	350	400	7.0	94.0	10	8.0	5.0	0.8	8.0	1.6	25	320	500	4-119	
GSTU8040	TO-3	400	450	7.0	94.0	10	8.0	5.0	0.8	8.0	1.6	25	360	500	4-119	
GSTU8045	TO-3	450	500	7.0	94.0	10	8.0	5.0	0.8	8.0	1.6	25	400	500	4-119	
XGSQ7530	TO-66	300	350	7.0	25.0	10	7.5	5.0	0.7	7.5	1.5	30	200	280	4-143	
XGSQ7535	TO-66	350	400	7.0	25.0	10	7.5	5.0	0.7	7.5	1.5	30	200	320	4-143	
XGSQ7540	TO-66	400	450	7.0	25.0	10	7.5	5.0	0.7	7.5	1.5	30	200	360	4-143	
XGSR7530	TO-3	300	350	7.0	50.0	10	7.5	5.0	0.6	7.5	1.5	30	200	280	4-150	
XGSR7535	TO-3	350	400	7.0	50.0	10	7.5	5.0	0.6	7.5	1.5	30	200	320	4-150	
XGSR7540	TO-3	400	450	7.0	50.0	10	7.5	5.0	0.6	7.5	1.5	30	200	360	4-150	

Ic = 15 AMPS

DEVICE TYPE	PACKAGE	V _{CE0} VOLTS	V _{CB0} VOLTS	V _{EBO} VOLTS	P _D @ 100°C WATTS	h _{FE} @ Min.	I _C Max. AMPS	V _{CE} VOLTS	V _{CE(sat)} @ I _C VOLTS	I _C AMPS	I _B AMPS	f _T MHz	I _{CB0} @ V _{CB} μAMP VOLTS	DATA SHEET PG. NO.
GSDR10020	TO-3	200	250	7.0	80.0	10	10	5.0	0.6	10	2.0	25	500	200 4-105
GSDR10025	TO-3	250	300	7.0	80.0	10	10	5.0	0.6	10	2.0	25	500	240 4-105
GSTR12030	TO-3	300	350	7.0	94.0	10	12	5.0	0.8	12	2.4	25	500	280 4-121
GSTR12035	TO-3	350	400	7.0	94.0	10	12	5.0	0.8	12	2.4	25	500	320 4-121
GSTR12040	TO-3	400	450	7.0	94.0	10	12	5.0	0.8	12	2.4	25	500	360 4-121
XDAR10030	TO-3	300	350	8.0	75.0	30	10	5.0	0.8	10	2.0	25	500	280 4-123
XDAR10035	TO-3	350	400	8.0	75.0	25	10	5.0	0.8	10	2.0	25	500	320 4-123
XGSR10030	TO-3	300	350	7.0	75.0	15	10	5.0	0.8	10	2.0	25	500	280 4-153
XGSR10035	TO-3	350	400	7.0	75.0	10	10	5.0	0.8	10	2.0	25	500	320 4-153
XGSR10040	TO-3	400	450	7.0	75.0	10	10	5.0	0.8	10	2.0	25	500	360 4-153

Ic = 20 AMPS

DEVICE TYPE	PACKAGE	V _{CE0} VOLTS	V _{CB0} VOLTS	V _{EBO} VOLTS	P _D @ 100°C WATTS	h _{FE} @ Min.	I _C Max. AMPS	V _{CE} VOLTS	V _{CE(sat)} @ I _C VOLTS	I _C AMPS	I _B AMPS	f _T MHz	I _{CB0} @ V _{CB} μAMP VOLTS	DATA SHEET PG. NO.
2N2815	TO-63	80	80	6.0	118.0	10 - 50	10.0	3.0	1.5	10	1.0	20	2.0mA	80
2N2816	TO-63	100	100	6.0	118.0	10 - 50	10.0	3.0	1.5	10	1.0	20	2.0mA	100 4-15
2N2817	TO-63	150	150	6.0	118.0	10 - 50	10.0	3.0	1.5	10	1.0	20	2.0mA	150 4-15
2N2818	TO-63	200	200	6.0	118.0	10 - 50	10.0	3.0	1.5	10	1.0	20	2.0mA	200 4-15
2N3265	TO-63	90	150	7.0	100.0	20 - 55	15.0	2.0	1.0	15	1.5	20	20.0mA	150
2N3266	TO-63	60	120	7.0	100.0	20 - 80	15.0	3.0	1.0	15	1.5	20	20.0mA	120
2N3597	TO-63	40	40	8.0	100.0	40 - 120	10.0	2.0	0.5	10	1.0	30	0.1	60
2N3598	TO-63	60	60	8.0	100.0	40 - 120	10.0	2.0	0.5	10	1.0	30	0.1	60
2N3599	TO-63	80	80	8.0	100.0	40 - 120	10.0	2.0	0.5	10	1.0	30	0.1	60
2N4210	TO-63	60	60	10.0	100.0	20 - 100	10.0	6.0	3.0	20	2.0	10	500	80
2N4211	TO-63	80	80	10.0	100.0	20 - 100	10.0	6.0	3.0	20	2.0	10	500	100
2N5731	TO-61/150	80	100	5.0	37.5	30 - 300	5.0	2.0	1.2	10	1.0	30		
2N5732	TO-3	80	80	5.0	50.0	30 - 300	5.0	2.0	1.2	10	1.0	30	1.0mA	100 4-69
2N6653	TO-3	300	350	7.0	75.0	10	15.0	2.0	0.6	15	3.0	25	100	280 4-97
2N6654	TO-3	350	400	7.0	75.0	10	15.0	2.0	0.6	15	3.0	25	100	320 4-97
2N6655	TO-3	400	450	7.0	75.0	10	15.0	2.0	0.8	15	3.0	25	100	360 4-97
GSDR15020	TO-3	200	250	7.0	80.0	10	15.0	5.0	0.8	15	3.0	25	500	200 4-107
GSDR15025	TO-3	250	300	7.0	80.0	10	15.0	5.0	0.8	15	3.0	25	500	240 4-107
XGSR15030	TO-3	300	350	7.0	75.0	10	15.0	5.0	0.6	15	3.0	25	500	280 4-97
XGSR15035	TO-3	350	400	7.0	75.0	10	15.0	5.0	0.6	15	3.0	25	500	320 4-97
XGSR15040	TO-3	400	450	7.0	75.0	10	15.0	5.0	0.8	15	3.0	25	500	360 4-97

Ic = 25 AMPS

DEVICE TYPE	PACKAGE	V _{CE0} VOLTS	V _{CB0} VOLTS	V _{EBO} VOLTS	P _D @ 100°C WATTS	h _{FE} @ Min.	I _C Max. AMPS	V _{CE} VOLTS	V _{CE(sat)} @ I _C VOLTS	I _C AMPS	I _B AMPS	f _T MHz	I _{CB0} @ V _{CB} μAMP VOLTS	DATA SHEET PG. NO.
2N2819	TO-63	80	90	6.0	118.0	10 - 50	15	3.0	1.0	10	1.0	20		
2N2820	TO-63	100	100	6.0	118.0	10 - 50	15	3.0	1.0	10	1.0	20		
2N2821	TO-63	150	150	6.0	118.0	10 - 50	15	3.0	1.0	10	1.0	20		4-17
2N2822	TO-63	200	200	6.0	118.0	10 - 50	15	3.0	1.0	10	1.0	20		
2N6338	TO-3	100	120	6.0	114.0	30 - 120	10	2.0	1.8	25	2.5	40	10	100 4-93
2N6339	TO-3	120	140	6.0	114.0	30 - 120	10	2.0	1.8	25	2.5	40	10	120 4-93
2N6340	TO-3	140	160	6.0	114.0	30 - 120	10	2.0	1.8	25	2.5	40	10	140 4-95
2N6341	TO-3	150	180	6.0	114.0	30 - 120	10	2.0	1.8	25	2.5	40	10	150 4-95

Ic = 30 AMPS

DEVICE TYPE	PACKAGE	BV _{CEO} VOLTS	BV _{CBO} VOLTS	BV _{EBO} VOLTS	P _D @ 100°C WATTS	h _{FE} @		I _C CE AMPS	V _{CE} VOLTS	V _{CE(sat)} @ I _C AMPS		I _B AMPS	f _T MHz	I _{CBO} @ V _{CB} μAMP VOLTS		DATA SHEET PG. NO.
						Min.	Max.			Volts	Volts			μAMP	Volts	
2N2823	TO-63	80	80	6.0	118	10 - 40	20.0	3.0	0.6	10	1.0	20				
2N2824	TO-63	100	100	6.0	118	10 - 40	20.0	3.0	0.6	10	1.0	20				
2N2825	TO-63	150	150	6.0	118	10 - 40	20.0	3.0	0.6	10	1.0	20				4-19
2N4002	TO-63	80	80	8.0	100	20 - 80	4.0	4.0	1.2	30	4.0	30	1.0mA	90		4-31
2N4003	TO-63	100	100	8.0	100	20 - 80	4.0	4.0	1.2	30	4.0	30	1.0mA	110		4-31
2N5733	TO-63	80	80	5.0	100	30 - 300	2.0	2.0	1.2	20	2.0	30	1.0mA	100		
2N5734	TO-3	80	80	5.0	100	30 - 300	2.0	2.0	1.2	20	2.0	30	1.0mA	100		
XGSR50020	TO-3	200	250	8.0	100.0	8	30	5.0	2.0	50	10.0	30	500	200		4-157

Ic = 40 AMPS

DEVICE TYPE	PACKAGE	BV _{CEO} VOLTS	BV _{CBO} VOLTS	BV _{EBO} VOLTS	P _D @ 100°C WATTS	h _{FE} @		I _C CE AMPS	V _{CE} VOLTS	V _{CE(sat)} @ I _C AMPS		I _B AMPS	f _T MHz	I _{CBO} @ V _{CB} μAMP VOLTS		DATA SHEET PG. NO.
						Min.	Max.			Volts	Volts			μAMP	Volts	
2N6033	TO-3(Mod)120	120	150	7.0	80	10 - 50	40	2.0	1.0	40	4.0	50	10mA	135		4-73

Ic = 50 AMPS

DEVICE TYPE	PACKAGE	BV _{CEO} VOLTS	BV _{CBO} VOLTS	BV _{EBO} VOLTS	P _D @ 100°C WATTS	h _{FE} @		I _C CE AMPS	V _{CE} VOLTS	V _{CE(sat)} @ I _C AMPS		I _B AMPS	f _T MHz	I _{CBO} @ V _{CB} μAMP VOLTS		DATA SHEET PG. NO.
						Min.	Max.			Volts	Volts			μAMP	Volts	
2N6032	TO-3(Mod)90	90	120	7.0	80.0	10 - 50	50	2.6	1.3	50	5.0	50	12mA	110		4-71
2N6215	TO-63	80	100	8.0	125.0	25 - 125	25	2.0	1.0	20	2.0	20	200	100		
2N6274	TO-3(Mod)100	100	120	6.0	143.0	30 - 120	20	4.0	1.0	20	2.0	30	10	120		4-83
2N6275	TO-3(Mod)120	120	140	6.0	143.0	30 - 120	20	4.0	1.0	20	2.0	30	10	140		4-85
2N6276	TO-3(Mod)140	140	160	6.0	143.0	30 - 120	20	4.0	1.0	20	2.0	30	10	140		4-85
2N6277	TO-3(Mod)150	150	180	6.0	143.0	30 - 120	20	4.0	1.0	20	2.0	30	10	180		4-87
2N6278	TO-63	100	120	6.0	143.0	30 - 120	20	4.0	1.0	20	2.0	30	10	120		4-89
2N6279	TO-63	120	140	6.0	143.0	30 - 120	20	4.0	1.0	20	2.0	30	10	140		4-91
2N6280	TO-63	140	160	6.0	143.0	30 - 120	20	4.0	1.0	20	2.0	30	10	160		4-91
2N6281	TO-63	150	180	6.0	143.0	30 - 120	20	4.0	1.0	20	2.0	30	10	180		4-91
GSD550020	TO-3(Mod)200	200	200	7.0	100.0	8	50	4.0	1.0	50	10.0	30	10	200		4-109



**GENERAL
SEMICONDUCTOR
INDUSTRIES, INC.**

C²R

**2N2817
2N2818**

NPN SWITCHING POWER TRANSISTORS

This unique series utilizes General Semiconductor Industries' C²R process (patent applied for) which describes a manufacturing technology that provides surface stabilization for high voltage operation and enhances long term reliability.

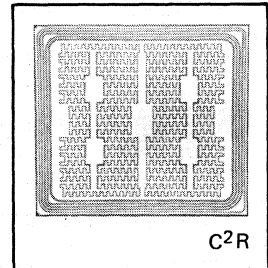
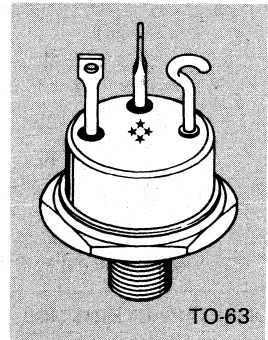

4

**NPN SWITCHING
TRANSISTORS**

MAXIMUM RATINGS

RATINGS	SYMBOL	2N2817	2N2818	UNIT
Collector-Base Voltage	V_{CBO}	150V	200	Vdc
Collector-Emitter Voltage	V_{CEO}	150	200	Vdc
Emitter-Base Voltage	V_{EBO}	10		Vdc
Collector Current - Continuous	I_C	20		Adc
Base Current - Continuous	I_B	4.5		Adc
Total Power Dissipation @ $T_C=25^\circ\text{C}$	P_D	200		Watt
Storage Temperature	T_{stg}	-65 to +200		$^\circ\text{C}$

ELECTRICAL CHARACTERISTICS (T = 25°C unless otherwise specified)

CHARACTERISTIC		SYMBOL	MIN	TYP	MAX	UNIT
OFF CHARACTERISTICS						
Collector-Emitter Sustaining Voltage ($I_C=100\text{mA}$)	2N2817 2N2818	BV_{CEO} (sus)	150 200			Vdc
Emitter Cutoff Current ($V_{EB}=10\text{V}$)		I_{EBO}			250	μA
Collector Cutoff Current ($V_{CE}=150\text{V}$, $V_{BE}=-1.5\text{V}$, $T_C=150^\circ\text{C}$) ($V_{CE}=150\text{V}$, $V_{BE}=-1.5\text{V}$)	2N2817 2N2817	I_{CEX}			20 2	mA
Collector Cutoff Current ($V_{CE}=200\text{V}$, $V_{BE}=-1.5\text{V}$, $T_C=150^\circ\text{C}$) ($V_{CE}=200\text{V}$, $V_{BE}=-1.5\text{V}$)	2N2818 2N2818	I_{CEX}			20 2	mA

ON CHARACTERISTICS

DC Current Gain ($V_{CE}=3\text{V}$, $I_C=10\text{A}$)		h_{FE}^*	10		50	
Collector Saturation Voltage ($I_C=10\text{A}$, $I_B=1.5\text{A}$)		$V_{CE}(\text{sat})^*$			1.5	Vdc
Base Emitter Voltage ($I_C=10\text{A}$, $I_B=1.5\text{A}$)		V_{BE}^*			2.5	Vdc

DYNAMIC CHARACTERISTICS

Small Signal Current Gain ($V_{CE}=5\text{V}$, $I_C=10\text{A}$, $f=1\text{MHz}$)		$ h_{fe} $.6			
Turn-on Time ($V_{CC}=30\text{V}$, $I_C=10\text{A}$, $I_{B1}=1.5\text{A}$, $I_{B2}=1.5\text{A}$)		t_{on}			3.5	μs
Turn-off Time ($V_{CC}=30\text{V}$, $I_C=10\text{A}$, $I_{B1}=1.5\text{A}$, $I_{B2}=-1.5\text{A}$)		t_{off}			12.0	μs
Rise Time ($V_{CC}=30\text{V}$, $I_C=10\text{A}$, $I_{B1}=1.5\text{A}$, $I_{B2}=1.5\text{A}$)		t_r			3.5	μs
Storage Time ($V_{CC}=30\text{V}$, $I_C=10\text{A}$, $I_{B1}=1.5\text{A}$, $I_{B2}=1.5\text{A}$)		t_s			6.0	μs
Fall Time ($V_{CC}=30\text{V}$, $I_C=10\text{A}$, $I_{B1}=1.5\text{A}$, $I_{B2}=1.5\text{A}$)		t_f			6.0	μs

*Pulse measurement conditions: Length = 300 μs , Duty Cycle \leq 2%.



**GENERAL
SEMICONDUCTOR
INDUSTRIES, INC.**

**C²R
2N2821**

NPN SWITCHING POWER TRANSISTORS

This unique device utilizes General Semiconductor Industries' C²R process (patent applied for) which describes a manufacturing technology that provides surface stabilization for high voltage operation and enhances long term reliability.

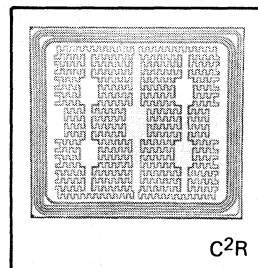
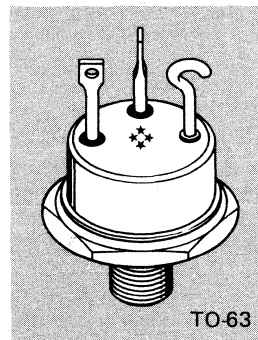

4
NPN SWITCHING
TRANSISTORS

MAXIMUM RATINGS

RATINGS	SYMBOL	2N2821	UNIT
Collector-Base Voltage	V_{CBO}	150	Vdc
Collector-Emitter Voltage	V_{CEO}	150	Vdc
Emitter-Base Voltage	V_{EBO}	10	Vdc
Collector Current - Continuous	I_C	25	Adc
Base Current - Continuous	I_B	4.5	Adc
Total Power Dissipation @ $T_C=25^\circ\text{C}$	P_D	200	Watt
Storage Temperature	T_{stg}	-65 to +200	$^\circ\text{C}$

ELECTRICAL CHARACTERISTICS (T = 25°C unless otherwise specified)

CHARACTERISTIC	SYMBOL	MIN	TYP	MAX	UNIT
----------------	--------	-----	-----	-----	------

OFF CHARACTERISTICS

Collector-Emitter Sustaining Voltage ($I_C=100\text{mA}$)	$V_{CEO(sus)}$	150			Vdc
Emitter Cutoff Current ($V_{EB}=10\text{V}$)	I_{EBO}			250	μA
Collector Cutoff Current ($V_{CE}=150\text{V}$, $V_{BE} = -1.5\text{V}$, $T_C=150^\circ\text{C}$)	I_{CEX}			20	mA
Collector Cutoff Current ($V_{CE}=150\text{V}$, $V_{BE} = -1.5\text{V}$)	I_{CEX}			2	mA

ON CHARACTERISTICS

DC Current Gain ($V_{CE}=3\text{V}$, $I_C=15\text{A}$)	h_{FE}^*	10		50	
Collector Saturation Voltage ($I_C=15\text{A}$, $I_B=2.2\text{A}$)	$V_{CE(sat)}^*$			1.5	Vdc
Base Emitter Voltage ($I_C=15\text{A}$, $I_B=2.2\text{A}$)	V_{BE}^*			2.5	Vdc

DYNAMIC CHARACTERISTICS

Small Signal Current Gain ($V_{CE}=3\text{V}$, $I_C=15\text{A}$, $f=1\text{MHz}$)	$ h_{fe} $	0.6			
Turn-on Time ($V_{CC}=30\text{V}$, $I_C=15\text{A}$, $I_{B1}=2.2\text{A}$, $I_{B2}=2.2\text{A}$)	t_{on}			3.5	μs
Turn-off Time ($V_{CC}=30\text{V}$, $I_C=15\text{A}$, $I_{B1}=2.2\text{A}$, $I_{B2}=2.2\text{A}$)	t_{off}			12.0	μs
Rise Time ($V_{CC}=30\text{V}$, $I_C=15\text{A}$, $I_{B1}=2.2\text{A}$, $I_{B2}=2.2\text{A}$)	t_r			3.5	μs
Storage Time ($V_{CC}=30\text{V}$, $I_C=15\text{A}$, $I_{B1}=2.2\text{A}$, $I_{B2}=2.2\text{A}$)	t_s			6.0	μs
Fall Time ($V_{CC}=30\text{V}$, $I_C=15\text{A}$, $I_{B1}=2.2\text{A}$, $I_{B2}=2.2\text{A}$)	t_f			6.0	μs

*Pulse measurement conditions: Length = 300 μs , Duty Cycle $\leq 2\%$.



**GENERAL
SEMICONDUCTOR
INDUSTRIES, INC.**

C²R[®]

2N2825

NPN SWITCHING POWER TRANSISTORS

This unique device utilizes General Semiconductor Industries' C²R process (patent applied for) which describes a manufacturing technology that provides surface stabilization for high voltage operation and enhances long term reliability.

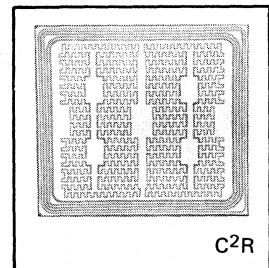
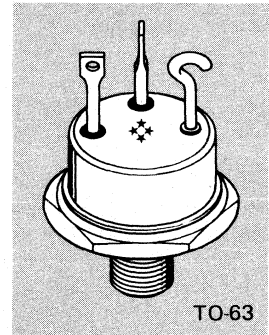

4

NPN SWITCHING
TRANSISTORS

MAXIMUM RATINGS

RATINGS	SYMBOL	2N2825	UNIT
Collector-Base Voltage	V_{CBO}	150	Vdc
Collector-Emitter Voltage	V_{CEO}	150	Vdc
Emitter-Base Voltage	V_{EBO}	10	Vdc
Collector Current - Continuous	I_C	30	Adc
Base Current - Continuous	I_B	4.5	Adc
Total Power Dissipation @ $T_C=25^\circ\text{C}$	P_D	200	Watt
Storage Temperature	T_{stg}	-65 to +200	$^\circ\text{C}$

ELECTRICAL CHARACTERISTICS (T = 25°C unless otherwise specified)

CHARACTERISTIC	SYMBOL	MIN	TYP	MAX	UNIT
----------------	--------	-----	-----	-----	------

OFF CHARACTERISTICS

Collector-Emitter Voltage ($I_C=100\text{mA}$)	V_{CE0}	150			Vdc
Emitter Cutoff Current ($V_{EB}=10\text{V}$)	I_{EBO}			250	μA
Collector Cutoff Current ($V_{CE}=150\text{V}$, $V_{BE} = -1.5\text{V}$, $T_C=150^\circ\text{C}$)	I_{CEX}			20	mA
Collector Cutoff Current ($V_{CE}=150$, $V_{BE} = -1.5\text{V}$)	I_{CEX}			2	mA

ON CHARACTERISTICS

DC Current Gain ($V_{CE}=2\text{V}$, $I_C=20\text{A}$)	h_{FE}^*	10		40	
Collector Saturation Voltage ($I_C=20\text{A}$, $I_B=3\text{A}$)	$V_{CE}(\text{sat})^*$			1.1	Vdc
Base Emitter Voltage ($I_C=20\text{A}$, $I_B=3\text{A}$)	V_{BE}^*			2.1	Vdc

DYNAMIC CHARACTERISTICS

Small Signal Current Gain ($V_{CE}=3\text{V}$, $I_C=20\text{A}$, $f=1\text{MHz}$)	$ h_{fe} $	0.6			
Turn-on Time ($V_{CC}=30\text{V}$, $I_C=20\text{A}$, $I_{B1}=3\text{A}$, $I_{B2}=3\text{A}$)	t_{on}			3.5	μs
Turn-off Time ($V_{CC}=30\text{V}$, $I_C=20\text{A}$, $I_{B1}=3\text{A}$, $I_{B2}=3\text{A}$)	t_{off}			12.0	μs
Rise Time ($V_{CC}=30\text{V}$, $I_C=20\text{A}$, $I_{B1}=3\text{A}$, $I_{B2}=3\text{A}$)	t_r			3.5	μs
Storage Time ($V_{CC}=30\text{V}$, $I_C=20\text{A}$, $I_{B1}=3\text{A}$, $I_{B2}=3\text{A}$)	t_s			6.0	μs
Fall Time ($V_{CC}=30\text{V}$, $I_C=20\text{A}$, $I_{B1}=3\text{A}$, $I_{B2}=3\text{A}$)	t_f			6.0	μs

*Pulse measurement conditions: Length = 300 μs , Duty Cycle \leq 2%.



GENERAL SEMICONDUCTOR INDUSTRIES, INC.

2N 2877
2N 2878
2N 2879
2N 2880

DIFFUSED SILICON EPITAXIAL PASSIVATED TRANSISTOR

These devices are designed for use in power amplifiers and switching applications. The latest technologies are used to offer the highest degree of reliability.

FEATURES

- Low Saturation Voltage
- High Frequency Response
- Fast Switching
- Low Leakage Current
- Low Drive Requirement

APPLICATIONS

- High Frequency Inverters
- Converters
- Linear Amplifiers
- High Speed Switching
- Regulated Power Supplies
- RF Power Amplifiers

ABSOLUTE MAXIMUM RATINGS

Maximum Temperatures	
Storage Temperatures	-65°C to +200°C
Operating Junction Temperature	+200°C
Lead Temperature (soldering, 60 second time limit)	+300°C

Maximum Power Dissipation	
Total Dissipation at 100°C Case Temperature	30 Watts
(1) See Safe Operating Curves for derating	
Linear derating factor	.3W/°C

	2N2877	2N2879
Maximum Voltages and Current		
V _{CEO} Collector to Emitter Voltage	60 Volts	80 Volts
V _{CBO} Collector to Base Voltage	80 Volts	100 Volts
V _{EBO} Emitter to Base Voltage	8 Volts	8 Volts
I _C Collector Current	5 Amps	5 Amps

MECHANICAL CHARACTERISTICS

Case: TO-111 Package
Weight: 6.5 grams (Maximum)
Leads: Tin Plated Kovar
1. Emitter 2. Base 3. Collector
Body marked with Logo  and type number

NPN SILICON HIGH-POWER TRANSISTORS

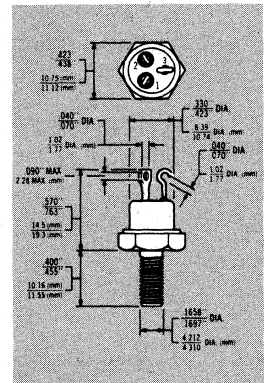
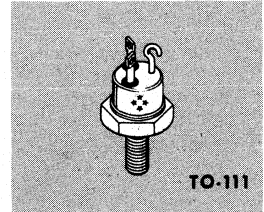

4
NPN SWITCHING TRANSISTORS

ELECTRICAL CHARACTERISTICS (25°C Case Temperature unless otherwise noted)

CHARACTERISTIC	SYMBOL	TEST CONDITIONS	2N2877		2N2878		2N2879		2N2880		UNITS
			MIN	MAX	MIN	MAX	MIN	MAX	MIN	MAX	
Collector to Base Breakdown Voltage	BV _{CBO}	I _C = 10μA, I _E = 0	80		80		100		100		Volts
Collector to Emitter Sustaining Voltage	V _{CEO} (sust)	I _C = 100mA, I _B = 0	50		50		70		70		Volts
Collector to Emitter Breakdown Voltage	BV _{CEO}	I _C = 10mA, I _B = 0	60		60		80		80		Volts
Emitter to Base Breakdown Voltage	BV _{EBO}	I _E = 10μA, I _C = 0	8		8		8		8		Volts
*DC Pulse Current Gain	h _{FE}	I _C = 1A, V _{CE} = 2V	20	60	40	120	20	60	40	120	
*DC Pulse Current Gain	h _{FE}	I _C = 5A, V _{CE} = 5V	10		15		10		15		
*DC Pulse Current Gain	h _{FE}	I _C = 1A, V _{CE} = 2V @ T _C = -55°C	10		10		10		10		
*Pulsed Collector Saturation	V _{CE} (sat)	I _C = 1A, I _B = 0.1A		0.25		0.25		0.25		0.25	Volts
		I _C = 5A, I _B = 0.5A		2.0		2.0		2.0		2.0	Volts
*Pulsed Base Emitter Voltage	V _{BE}	I _C = 1A, V _{CE} = 2V		1.2		1.2		1.2		1.2	Volts
*Pulsed Base Saturation Voltage	V _{BE} (sat)	I _C = 1A, I _B = 0.1A		1.2		1.2		1.2		1.2	Volts
Collector Cutoff Current	I _{CBO}	V _{CB} = 80V, I _E = 0		0.1		0.1		0.1		0.1	μAmp
Collector Cutoff Current	I _{CEO}	V _{CE} = 50V, I _B = 0		100		100		100		100	μAmp
Collector Cutoff Current	I _{EBO}	V _{EB} = 5V, I _C = 0		0.1		0.1		0.1		0.1	μAmp
Collector Cutoff Current	I _{EBO}	V _{EB} = 8V, I _C = 0		10		10		10		10	μAmp
Collector Cutoff Current	I _{CEX}	V _{EB} = 0.5V, V _{CE} = 80V @ T _C = 150°C		50		50		50		50	μAmp

*Pulse measurement conditions = length ≤ 300 μsec; duty cycle ≤ 2%.



GENERAL SEMICONDUCTOR INDUSTRIES, INC.

2001 West Tenth Place, Tempe, Arizona 85281 • 602 968 3101 • TWX910 950 1942
Mailing Address: P.O. Box 3078

GENERAL SEMICONDUCTOR INDUSTRIES, INC.

DYNAMIC CHARACTERISTICS

CHARACTERISTIC	SYMBOL	TEST CONDITIONS	2N2877 2N2878		2N2878 2N2880		UNITS
			MIN	MAX	MIN	MAX	
Pulse Rise Time	t_r	See Circuit #1		120		80	nsec
Pulse Storage Time	t_s	See Circuit #1		60		60	nsec
Pulse Fall Time	t_f	See Circuit #1		80		80	nsec
Collector Base Capacitance (f = 1.0 MHz)	C_{OB}	$V_{CB} = 10V, I_E = 0, f = 1 \text{ MHz}$		150		150	pF
High Frequency Current Gain (f = 10 MHz)	$ h_{fe} $	$V_{CE} = 10V, I_C = 1A, f = 10 \text{ MHz}$	3		5		
High Frequency Small Signal (f = 1 kHz)	h_{fe}	$V_{CE} = 5V, I_C = 50mA, f = 1 \text{ KHz}$	20	70	40	140	

**MAXIMUM SAFE OPERATION REGION
2N2877, 2N2878**

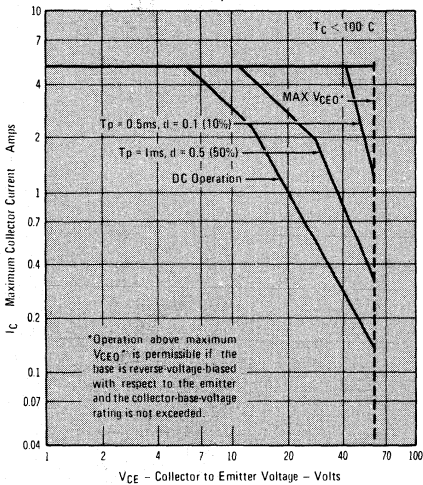

**MAXIMUM SAFE OPERATION REGION
2N2879, 2N2880**

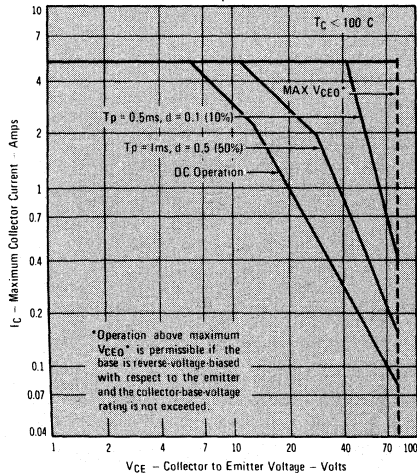

PULSE RESPONSE MEASUREMENT CIRCUIT

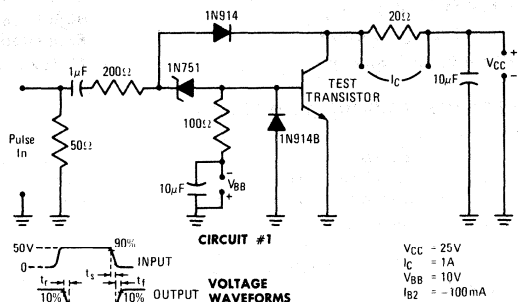

$V_{CC} = 25V$
 $I_C = 1A$
 $V_{BB} = 10V$
 $I_{B2} = -100mA$

COLLECTOR TO EMITTER VOLTAGE VS. COLLECTOR CURRENT

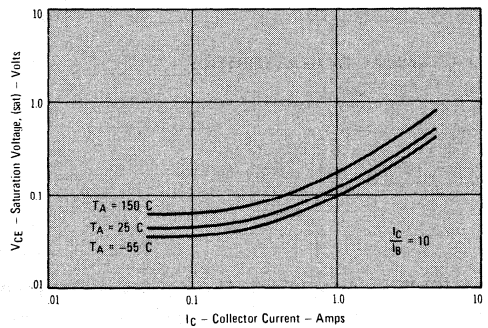

NORMALIZED CURRENT GAIN VS. COLLECTOR CURRENT

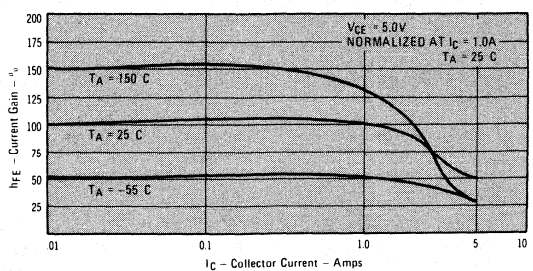

GENERAL SEMICONDUCTOR INDUSTRIES, INC.

2001 West Tenth Place, Tempe, Arizona 85281 • 602 968 3101 • TWX910 950 1942
 Mailing Address: P. O. Box 3078

2N2877, 2878, 2879, 2880 Copyright General Semiconductor Industries, Inc., 7-75-A



**GENERAL
SEMICONDUCTOR
INDUSTRIES, INC.**

**2N3418
2N3419
2N3420
2N3421**

**NPN SILICON
POWER TRANSISTORS**

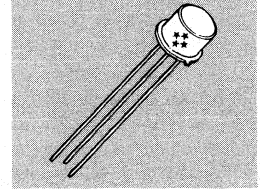

DIFFUSED SILICON EPITAXIAL PASSIVATED TRANSISTOR

These NPN devices are designed for use in high speed switching and medium power amplifier applications. JAN, JANTX, and JANTXV devices to MIL-S-19500/393 are available. The latest technologies are used to offer the highest degree of reliability.

FEATURES

- Fast Switching
- High Power Dissipation
- Low Leakage Current
- Low Saturation Voltage

APPLICATIONS

- Switching Regulators
- High Frequency Inverters
- Converters
- DC-RF Amplifiers

ABSOLUTE MAXIMUM RATINGS

Maximum Temperatures

Storage Temperature	-65°C to +200°C
Operating Junction Temperature	+200°C
Lead Temperature (Soldering, 60 second time limit)	+300°C

Maximum Power Dissipation

Total Dissipation at 100°C Case Temperature	15 Watts
Linear Derating Factor	0.15 W/°C

Maximum Voltages and Current

V_{CE0} Collector to Emitter Voltage	2N3418	2N3419
V_{CBO} Collector to Base Voltage	2N3420	2N3421
V_{EBO} Emitter to Base Voltage	60 Volts	80 Volts
I_C Collector Current	85 Volts	125 Volts
	8 Volts	8 Volts
	3 Amps	3 Amps

MECHANICAL CHARACTERISTICS

Case: TO-5 Package

Weight: 1.8 grams (maximum)

Leads: Gold Plated Kovar

1. Emitter 2. Base 3. Collector

Body marked with Logo "G" and type number

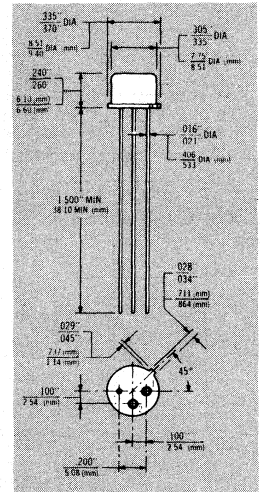

4

**NPN SWITCHING
TRANSISTORS**

ELECTRICAL CHARACTERISTICS (25°C Case Temperature unless otherwise noted)

CHARACTERISTIC	SYMBOL	TEST CONDITIONS	2N3418		2N3419		UNITS
			2N3420	2N3421	MIN.	MAX.	
*Collector to Emitter Sustaining Voltage	$V_{CE0(SUS)}$	$I_C = 50mA, I_E = 0$	60	80			Volts
Collector Cutoff Current	I_{CEX}	$V_{CE} = 80V, V_{BE} = -0.5V$	0.5				μ Amps
		$V_{CE} = 120V, V_{BE} = -0.5V$			0.5		μ Amps
Emitter Cutoff Current	I_{EBO}	$V_{EB} = 6V, I_C = 0$	0.5		0.5		μ Amps
		$V_{EB} = 8V, I_C = 0$	10		10		μ Amps
*Collector Saturation Voltage	$V_{CE(sat)}$	$I_C = 1A, I_B = 100mA$	0.25		0.25		Volts
		$I_C = 2A, I_B = 200mA$	0.5		0.5		Volts
*Base Saturation Voltage	$V_{BE(sat)}$	$I_C = 1A, I_B = 100mA$	0.6	1.2	0.6	1.2	Volts
		$I_C = 2A, I_B = 200mA$	0.7	1.4	0.7	1.4	Volts
*DC Current Gain (2N3418/19)	h_{FE}	$I_C = 1A, V_{CE} = 2V$	20 MIN. — 60 MAX.				
*DC Current Gain (2N3420/21)	h_{FE}	$I_C = 1A, V_{CE} = 2V$	40 MIN. — 120 MAX.				

* Pulse Measurement Conditions: Length = 300 μ sec; Duty cycle \leq 2%. Measured 1/8" from body using separate current carrying and voltage sensing contacts for each lead.



GENERAL SEMICONDUCTOR INDUSTRIES, INC.

2001 West Tenth Place, Tempe, Arizona 85281 • 602-968-3101 • TWX910-950-1942
Mailing Address: P. O. Box 3078

GENERAL SEMICONDUCTOR INDUSTRIES, INC.

DYNAMIC CHARACTERISTICS

CHARACTERISTIC	SYMBOL	TEST CONDITIONS	2N3418 2N3420		2N3419 2N3421		UNITS
			MIN.	MAX.	MIN.	MAX.	
Turn-On Time	t_{on}	See Figure 2		0.3	0.3		μ Sec
Turn-Off Time	t_{off}	See Figure 2		1.2	1.2		μ Sec
Collector Base Capacitance	C_{ob}	$V_{CE}=10V, f=1MHz$		150	150		pF
Collector Gain-Bandwidth Product	f_T	$I_C=1A, V_{CE}=10V, f=20MHz$	40		40		MHz

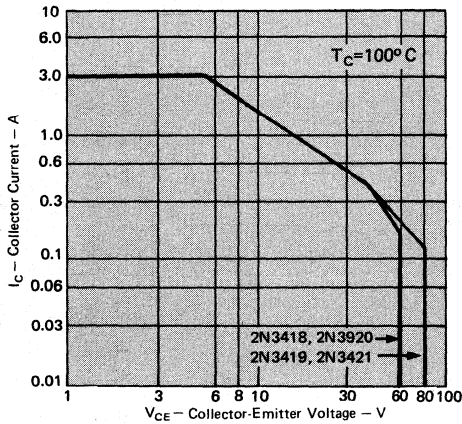

**Figure 1
MAXIMUM SAFE
OPERATING
REGION**

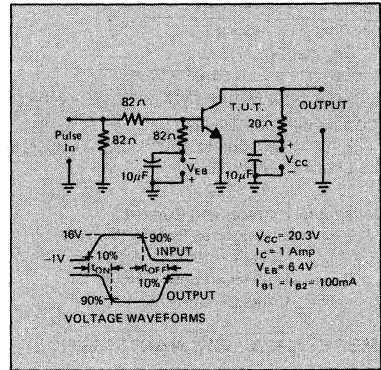

**Figure 2
SWITCHING
CIRCUIT**

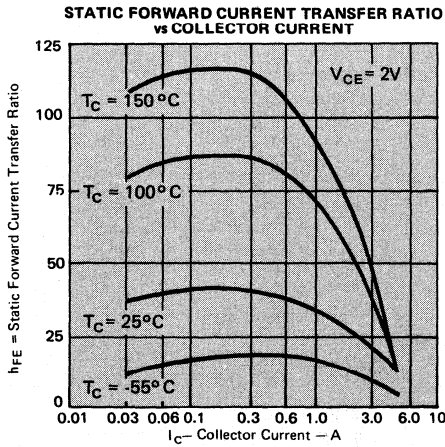

**Figure 3
TYPICAL DC
CURRENT GAIN
(2N3418 - 2N3419)**

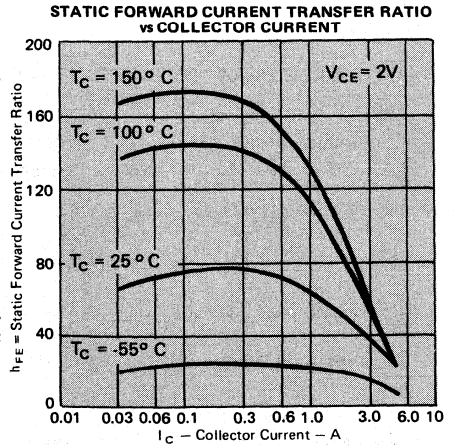

**Figure 4
TYPICAL DC
CURRENT GAIN
(2N3420 - 2N3421)**



GENERAL SEMICONDUCTOR INDUSTRIES, INC.

2001 West Tenth Place, Tempe, Arizona 85281 • 602-968-3101 • TWX910-950-1942
Mailing Address: P. O. Box 3078



GENERAL SEMICONDUCTOR INDUSTRIES, INC.

2N3506
2N3507
NPN SILICON
SWITCHING
TRANSISTORS

DIFFUSED SILICON EPITAXIAL PASSIVATED TRANSISTOR

These devices are designed for use in high-current, high-speed, saturated switching and core driver applications. The latest technologies are used to offer the highest degree of reliability. JAN, JANTX, & JANTXV to MIL-S-19500/349 are available.

FEATURES

- Fast Switching
- Low Saturation Voltage
- Minimum f_T of 60 MHz
- Low Leakage Current

APPLICATIONS

- High speed Switching
- Regulated Power Supplies
- Converters
- Inverters
- Core Drivers

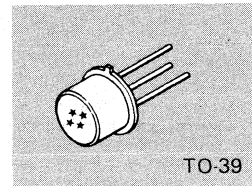

TO-39

ABSOLUTE MAXIMUM RATINGS

Maximum Temperatures

Storage Temperature	-65°C to +200°C
Operating Junction Temperature	+200°C
Lead Temperature (soldering, 60 second time limit)	+300°C

Maximum Power Dissipation

Total Dissipation at 25°C Case Temperature	.5 Watts
Linear Derating Factor	.28.6 mW/°C

Maximum Voltages and Current

	2N3506	2N3507
V_{CEO} Collector to Emitter Voltage	40 Volts	50 Volts
V_{CBO} Collector to Base Voltage	60 Volts	80 Volts
V_{EBO} Emitter to Base Voltage	5 Volts	5 Volts
I_C Collector Current	3 Amps	3 Amps

MECHANICAL CHARACTERISTICS

TO-39 Package

Weight: 1.8 grams (approximate)
 Lead material: Cover with Gold Plating
 Pin 1. Emitter 2. Base 3. Collector
 Body marked with Logo $\star\star$ and part number

ELECTRICAL CHARACTERISTICS (25°C Case Temperature unless otherwise noted)

CHARACTERISTIC	SYMBOL	TEST CONDITIONS	2N3506		2N3507		UNITS
			MIN.	MAX.	MIN.	MAX.	
Collector to Base Breakdown Voltage	BV_{CBO}	$I_C = 100 \mu A, I_E = 0$	60		80		Volts
*Collector to Emitter Breakdown Voltage	BV_{CEO}	$I_C = 10mA, I_B = 0$	40		50		Volts
Emitter to Base Breakdown Voltage	BV_{EBO}	$I_E = 10 \mu A, I_C = 0$	5		5		Volts
*DC Current Gain	h_{FE}	$I_C = 500mA, V_{CE} = 1V$	50		35		
*DC Current Gain	h_{FE}	$I_C = 1.5A, V_{CE} = 2V$	40	200	30	150	
*DC Current Gain	h_{FE}	$I_C = 2.5A, V_{CE} = 3V$	30		25		
*DC Current Gain	h_{FE}	$I_C = 3A, V_{CE} = 5V$	25		20		
*Collector Saturation Voltage	$V_{CE(SAT)}$	$I_C = 1.5A, I_B = 150mA$		1.0		1.0	Volts
		$I_C = 2.5A, I_B = 250mA$		1.5		1.5	Volts
*Base Saturation Voltage	$V_{BE(SAT)}$	$I_C = 1.5A, I_B = 150mA$	0.9	1.4	0.9	1.4	Volts
		$I_C = 2.5A, I_B = 250mA$		2.0		2.0	Volts
Collector Cutoff Current	I_{CEX}	$V_{CE} = 40V, V_{EB} = 4V$		1.0			μ Amps
		$V_{CE} = 60V, V_{EB} = 4V$				1.0	μ Amps
Base Cutoff Current	I_{BL}	$V_{CE} = 40V, V_{EB} = 4V$		1.0			μ Amps
		$V_{CE} = 60V, V_{EB} = 4V$				1.0	μ Amps

*Pulse Measurement Conditions=length $\leq 300 \mu sec$; duty cycle $\leq 2\%$.



GENERAL SEMICONDUCTOR INDUSTRIES, INC.

2001 West Tenth Place, Tempe, Arizona 85281 • 602-968-3101 • TWX910-950-1942
 Mailing Address: P.O. Box 3078

4
 NPN SWITCHING
 TRANSISTORS

GENERAL SEMICONDUCTOR INDUSTRIES, INC.

DYNAMIC CHARACTERISTICS

CHARACTERISTIC	SYMBOL	TEST CONDITIONS	MIN.	MAX.	UNITS
Delay Time	t_d	See Figure 2		15	nSec
Rise Time	t_r	See Figure 2		30	nSec
Storage Time	t_s	See Figure 2		55	nSec
Fall Time	t_f	See Figure 2		35	nSec
Collector Base Capacitance ($f=1.0\text{MHz}$)	C_{ob}	$V_{CE}=10\text{V}, I_E=0$		40	pF
Current Gain - Bandwidth Product ($f=20\text{MHz}$)	f_T	$I_C=100\text{mA}, V_{CE}=5\text{V}$	60		MHz

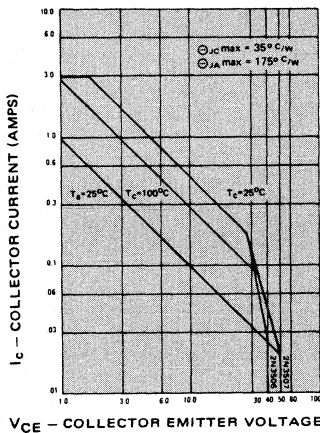

Figure 1
MAXIMUM SAFE
OPERATION
REGION

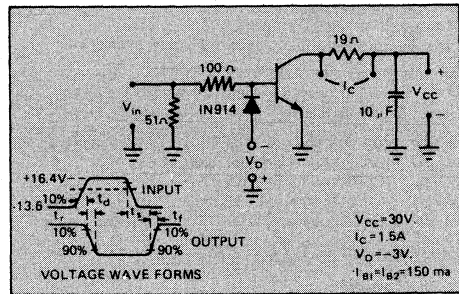

Figure 2
SWITCHING
CIRCUIT

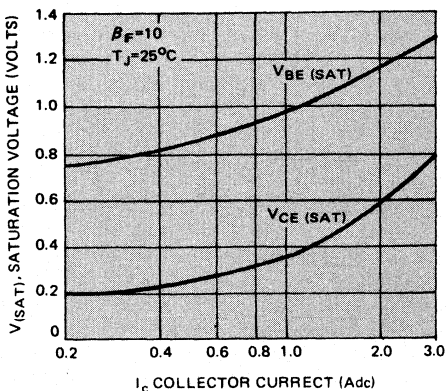

Figure 3
SATURATION
VOLTAGES

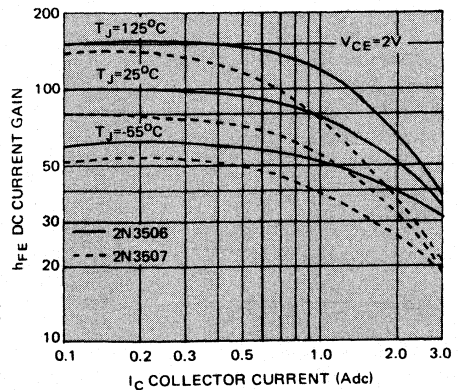

Figure 4
DC CURRENT
GAIN



GENERAL SEMICONDUCTOR INDUSTRIES, INC.

2001 West Tenth Place, Tempe, Arizona 85281 • 602-968-3101 • TWX910-950-1942
Mailing Address: P.O. Box 3078



**GENERAL
SEMICONDUCTOR
INDUSTRIES, INC.**

C²R

2N3738
2N3739

NPN SWITCHING POWER TRANSISTORS

This unique series utilizes General Semiconductor Industries' C²R process (patent applied for) which describes a manufacturing technology that provides surface stabilization for high voltage operation and enhances long term reliability.

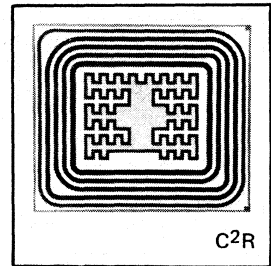
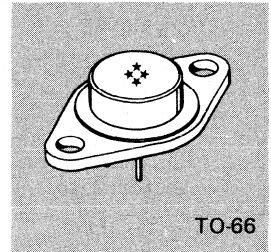

4

NPN SWITCHING
TRANSISTORS

MAXIMUM RATINGS

RATINGS	SYMBOL	2N3738	2N3739	UNIT
Collector-Base Voltage	V_{CBO}	250	325	Vdc
Collector-Emitter Voltage	V_{CEO}	225	300	Vdc
Emitter-Base Voltage	V_{EBO}	6.0		Vdc
Collector Current - Continuous	I_C	1.0		Adc
Base Current - Continuous	I_B	0.50		Adc
Total Power Dissipation @ $T_C=25^\circ\text{C}$	P_D	20		Watt
Junction Temperature	T_J	-65 to +175		$^\circ\text{C}$
Storage Temperature	T_{stg}	-65 to +175		$^\circ\text{C}$

ELECTRICAL CHARACTERISTICS (T = 25°C unless otherwise specified)

CHARACTERISTIC	SYMBOL	MIN	TYP	MAX	UNIT
----------------	--------	-----	-----	-----	------

OFF CHARACTERISTICS

Collector-Emitter Sustaining Voltage ($I_C=5.0mA$)	2N3738 2N3739	$V_{CEO(sus)}$	225 300		Vdc
Collector Cutoff Current ($V_{CB}=250V$) ($V_{CB}=325V$)	2N3738 2N3739	I_{CBO}		0.1 0.1	mA
Emitter Cutoff Current ($V_{EB}=6.0V$)		I_{EBO}		0.1	μA
Collector Cutoff Current ($V_{CE}=125V$) ($V_{CE}=200V$)	2N3738 2N3739	I_{CEO}		0.25 0.25	mA
Collector Cutoff Current ($V_{CE}=250V, V_{EB}=1.5V$) ($V_{CE}=300V, V_{EB}=1.5V$)	2N3738 2N3739	I_{CEV}		0.5 0.5	mA
Collector Cutoff Current ($V_{CE}=125V, V_{EB}=1.5V, T_C=100^\circ C$) ($V_{CE}=200V, V_{EB}=1.5V, T_C=100^\circ C$)	2N3738 2N3739	I_{CEV}		1.0 1.0	mA

ON CHARACTERISTICS

DC Current Gain ($V_{CE}=10V, I_C=50mA$)	h_{FE}^*	30			
DC Current Gain ($V_{CE}=10V, I_C=100mA$)	h_{FE}^*	40	200		
DC Current Gain ($V_{CE}=10V, I_C=250mA$)	h_{FE}^*	25			
Collector Saturation Voltage ($I_C=250mA, I_B=25mA$)	$V_{CE(sat)}^*$			2.5	Vdc
Base Emitter On Voltage ($I_C=100mA, V_{CE}=10V$)	$V_{BE(on)}^*$			1.0	Vdc

DYNAMIC CHARACTERISTICS

Current-Gain - Bandwidth Product ($I_C=100mA, V_{CE}=10V, f=10MHz$)	f_T	10			MHz
Small Signal Current Gain ($V_{CE}=20V, I_C=100mA, f=1.0KHz$)	$ h_{fe} $	35			
Collector Base Capacitance ($V_{CB}=100V, f=100KHz$)	C_{ob}			20	pF

*Pulse measurement conditions: Length = 300 μs , Duty Cycle $\leq 2\%$.



GENERAL SEMICONDUCTOR INDUSTRIES, INC.

2N3996
2N3997
2N3998
2N3999

DIFFUSED SILICON EPITAXIAL PASSIVATED TRANSISTOR

These devices are designed for use in power amplifiers and high speed switching applications. The latest technologies are used to offer the highest degree of reliability.

FEATURES

- Low Saturation Voltage
- Minimum f_t of 40 MHz
- Fast Switching
- Low Leakage Current
- Isolated Collector (2N3996, 2N3997)

APPLICATIONS

- High Frequency Inverters
- Converters
- Linear Amplifiers
- High Speed Switching Regulated Power Supplies
- RF Power Amplifiers

ABSOLUTE MAXIMUM RATINGS

Collector to Emitter Voltage	V_{CE0}	80 Volts
Collector to Base Voltage	V_{CB0}	100 Volts
Emitter to Base Voltage	V_{EB0}	8 Volts
Collector Current – Continuous	I_C	5 Amps
– Peak	I_C (Peak)	10 Amps
Base Current – Continuous	I_B	1 Amp
Total Device Dissipation, @ $T_C = 100^\circ C$	P_D	30 Watts
Linear Derating Factor	θ_{JC}	.3W/°C
Operating Junction and Storage Temperature Range	T_J, T_{stg}	-65°C to +200°C
Thermal Resistance – Junction to Case	θ_{JC}	3.33°C/W
– Junction to Ambient	θ_{JA}	87.5°C/W

MECHANICAL CHARACTERISTICS

Case: TO-111/1 (2N3996/7); TO-111 (2N3998/9)

1. Emitter 2. Base 3. Collector 4. Case
Body marked with Logo and type number
Weight: 5.3 grams (Approx.)

NPN SILICON HIGH POWER TRANSISTORS

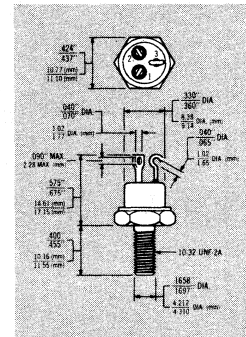
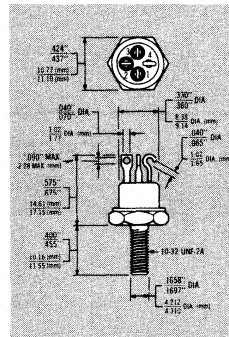
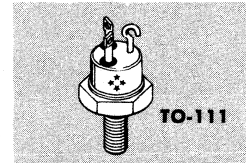
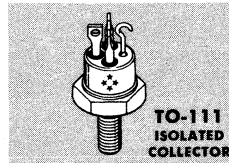

4

NPN SWITCHING TRANSISTORS

ELECTRICAL CHARACTERISTICS (25° Case Temperature unless otherwise noted)

CHARACTERISTIC	SYMBOL	TEST CONDITIONS	2N3996 2N3998		2N3997 2N3999		UNITS
			MIN	MAX	MIN	MAX	
Collector to Emitter Breakdown Voltage	V_{CE0}	* $I_C = 50\text{ mA}, I_B = 0$	80		80		Volts
Collector Cutoff Current	I_{CE0}	$V_{CE} = 60\text{ V}, I_B = 0$		10		10	µAmp
	I_{CES}	$V_{CE} = 90\text{ V}, V_{BE} = 0\text{ V}$		5.0		5.0	µAmp
		$V_{CE} = 90\text{ V}, V_{BE} = 0\text{ V} @ T_C 150^\circ C$		50		50	µAmp
Emitter Cutoff Current	I_{EBO}	$V_{EB} = 5\text{ V}, I_C = 0$		0.5		0.5	µAmp
		$V_{EB} = 8\text{ V}, I_C = 0$		10		10	µAmp
DC Current Gain	h_{FE}	$I_C = 50\text{ mA}, V_{CE} = 2\text{ V}$	30		60		
		* $I_C = 1\text{ A}, V_{CE} = 2\text{ V}$	40	120	80	240	
		* $I_C = 5\text{ A}, V_{CE} = 5\text{ V}$	15		20		
		* $I_C = 1\text{ A}, V_{CE} = 2\text{ V} @ T_C -55^\circ C$	10		20		
Collector Saturation Voltage	$V_{CE(sat)}$	* $I_C = 1\text{ A}, I_B = 0.1\text{ A}$		0.25		0.25	Volts
		* $I_C = 5\text{ A}, I_B = 0.5\text{ A}$		2.0		2.0	Volts
Base Emitter Saturation Voltage	$V_{BE(sat)}$	* $I_C = 1\text{ A}, I_B = 0.1\text{ A}$	0.6		0.6		Volts
		* $I_C = 5\text{ A}, I_B = 0.5\text{ A}$		1.6		1.6	Volts

DYNAMIC CHARACTERISTICS

Turn-on Time	t_{on}	See Figure 1	0.3		0.3		µsec
Turn-off Time	t_{off}	See Figure 1	1.5		2.0		µsec
Collector Base Capacitance	C_{ob}	$V_{CB} = 10\text{ V}, I_C = 0, f = 1\text{ MHz}$		150		150	pF
High Frequency Current Gain	$ h_{fe} $	$V_{CE} = 5\text{ V}, I_C = 1.0\text{ A}, f = 10\text{ MHz}$	4		4		

*Pulse measurement conditions = length = 300 µsec; duty cycle = 2%.



GENERAL SEMICONDUCTOR INDUSTRIES, INC.

2001 West Tenth Place, Tempe, Arizona 85281 • 602 968 3101 • TWX910-950 1942
Mailing Address: P.O. Box 3078

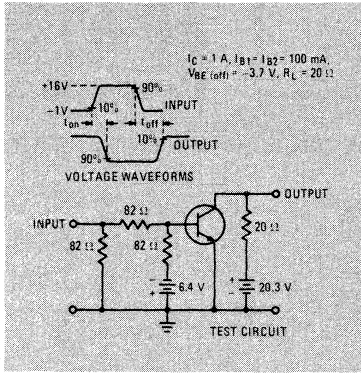

Figure 1 SWITCHING CIRCUIT

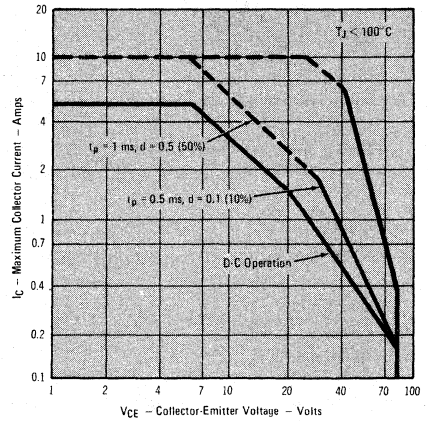

Figure 2 MAXIMUM SAFE OPERATING REGION

TYPICAL CHARACTERISTICS

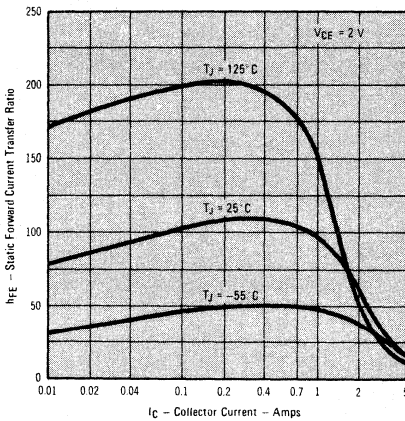

Figure 3 STATIC FORWARD CURRENT TRANSFER RATIO (2N3996, 2N3998)

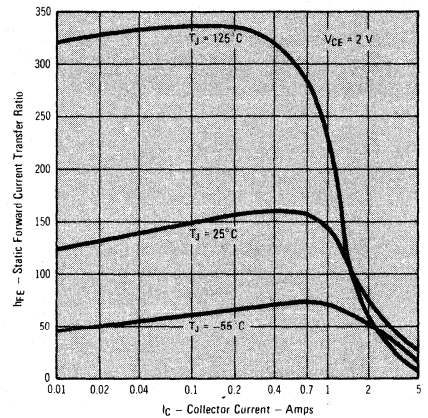

Figure 4 STATIC FORWARD CURRENT TRANSFER RATIO (2N3997, 2N3999)

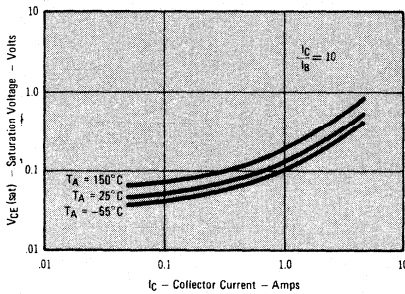

Figure 5 COLLECTOR TO EMITTER VOLTAGE

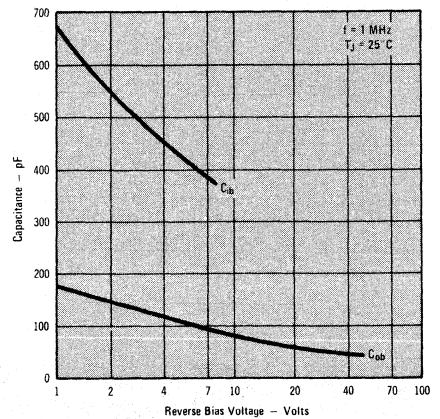

Figure 6 CAPACITANCE versus VOLTAGE



GENERAL SEMICONDUCTOR INDUSTRIES, INC.

2N4002
2N4003

DIFFUSED SILICON EPITAXIAL PASSIVATED TRANSISTORS

These NPN devices are designed for use in high power switching and untuned amplifier applications. The latest technologies are used to offer the highest degree of reliability.

FEATURES

- Fast Switching
- High Power Dissipation
- Low Leakage Current
- Low Saturation Voltage

APPLICATIONS

- Switching Regulators
- Inverters
- Converters
- Power Amplifiers

NPN SILICON POWER TRANSISTORS

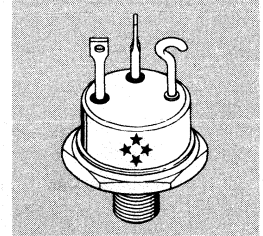

ABSOLUTE MAXIMUM RATINGS

Maximum Temperatures	
Storage Temperature	-65°C to +200°C
Operating Junction Temperature	+200°C
Lead Temperature (1/16 inch from case for 10 seconds)	+230°C

Maximum Power Dissipation	
Total Dissipation at 100°C Case Temperature	100 Watts
Linear Derating Factor	1.0 W/°C

Maximum Voltages and Current	2N4002	2N4003
V _{CEO} Collector to Emitter Voltage	80 Volts	100 Volts
V _{CBO} Collector to Base Voltage	100 Volts	120 Volts
V _{EBO} Emitter to Base Voltage	8 Volts	8 Volts
I _C Continuous Collector Current	30 Amps	30 Amps

MECHANICAL CHARACTERISTICS

Case: TO-63 Package

Weight: 24 grams (Approximate)

1. Emitter 2. Base 3. Collector

Body marked with Logo * and type number

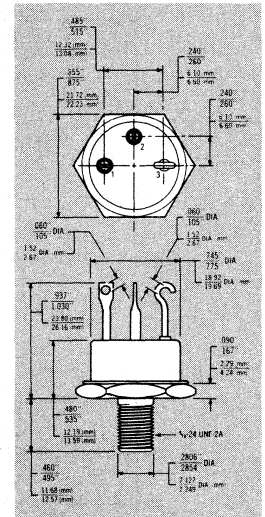

4

NPN SWITCHING
TRANSISTORS

ELECTRICAL CHARACTERISTICS (25°C Case Temperature unless otherwise noted)

CHARACTERISTIC	SYMBOL	TEST CONDITIONS	2N4002		2N4003		UNITS
			MIN	MAX	MIN	MAX	
*Collector to Emitter Breakdown Voltage	V _{CEO}	I _C = 30mA, I _B = 0	80		100		Volts
Collector Cutoff Current	I _{CEO}	V _{CE} = 40V, I _B = 0 V _{CE} = 50V, I _B = 0		2		2	mAmps
Emitter Cutoff Current	I _{EBO}	V _{EB} = 5V, I _C = 0 V _{EB} = 8V, I _C = 0		100 50		100 50	μAmps mAmps
*DC Current Gain	h _{FE}	V _{CE} = 4V, I _C = 30A V _{CE} = 4V, I _C = 15A	10 20	80	10 20	80	
*Collector Saturation Voltage	V _{CE(sat)}	I _B = 4A, I _C = 30A		1.2		1.2	Volts
*Base - Emitter Voltage	V _{BE(on)}	V _{CE} = 4V, I _C = 30A		1.8		1.8	Volts

*Pulse Measurement Conditions: Length = 300 μ sec; duty cycle ≤ 2%.



GENERAL SEMICONDUCTOR INDUSTRIES, INC.

2001 West Tenth Place, Tempe, Arizona 85281 • 602 968 3101 • TWX910 950 1942
Mailing Address: P.O. Box 3078

GENERAL SEMICONDUCTOR INDUSTRIES, INC.

DYNAMIC CHARACTERISTICS

CHARACTERISTICS	SYMBOL	TEST CONDITIONS	MIN	MAX	UNITS
Turn-on Time	t_{on}	See Figure 2		1.0	μ sec
Turn-off Time	t_{off}	See Figure 2		3.0	μ sec
High Frequency Small Signal Common Emitter Small Signal	$ h_{fe} $ h_{fe}	$V_{CE} = 10V, I_C = 1A, f = 10$ MHz $V_{CE} = 4V, I_C = 1A, f = 1$ KHz	3 30		

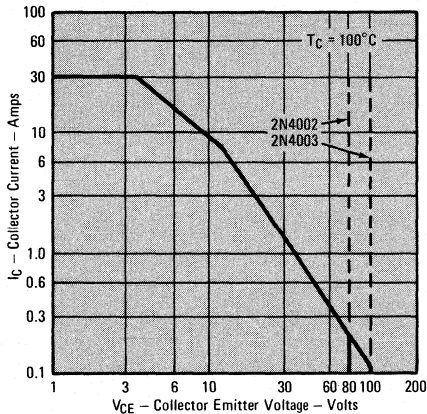

Figure 1 - MAXIMUM SAFE OPERATING REGION

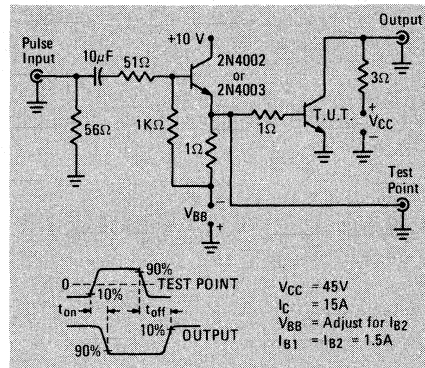

Figure 2 - SWITCHING CIRCUIT

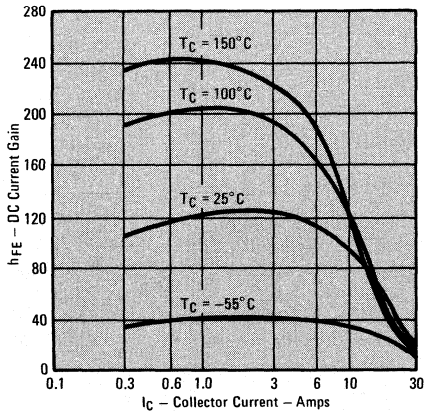

Figure 3 - TYPICAL DC CURRENT GAIN

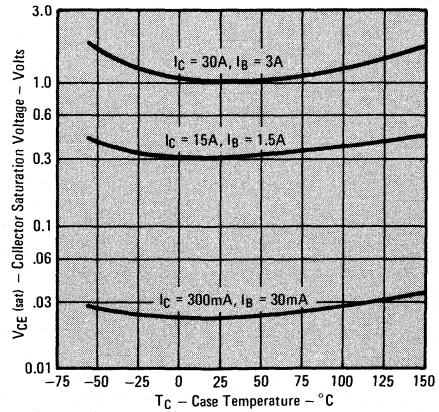

Figure 4 - SATURATION VOLTAGE VS. TEMPERATURE



GENERAL SEMICONDUCTOR INDUSTRIES, INC.

2001 West Tenth Place, Tempe, Arizona 85281 • 602-968-3101 • TWX910 950 1942
Mailing Address: P.O. Box 3078



**GENERAL
SEMICONDUCTOR
INDUSTRIES, INC.**

**NPN
2N4070**

SILICON NPN TRANSISTORS

These double diffused, epitaxial collector devices are oxide passivated. They are designed for use in switching and many amplifier applications. The latest technologies are used to provide optimum performance and the highest degree of reliability.

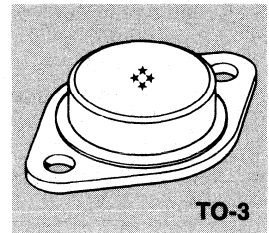

4

**NPN SWITCHING
TRANSISTORS**

ABSOLUTE MAXIMUM RATINGS

RATINGS	SYMBOL	2N4070	UNIT
Collector-Base Voltage	V_{CBO}	120	Vdc
Collector-Emitter Voltage	V_{CEO}	100	Vdc
Emitter-Base Voltage	V_{EBO}	8.0	Vdc
Collector Current — Continuous	I_C	10	Adc
Base Current — Continuous	I_B	5.0	Adc
Total Power Dissipation @ $T_C=100^\circ\text{C}$	P_D	65	Watt
Thermal Resistance (Junction to Case)	θ_{J-C}	1.53	$^\circ\text{C}/\text{W}$
Junction Temperature	T_J	-65 to +200	$^\circ\text{C}$
Storage Temperature	T_{stg}	-65 to +200	$^\circ\text{C}$

ELECTRICAL CHARACTERISTICS (T = 25°C unless otherwise specified)

CHARACTERISTIC	SYMBOL	MIN	TYP	MAX	UNIT
OFF CHARACTERISTICS					
Collector-Base Voltage ($I_C = 10\text{mA}$)	BV_{CBO}	120			Vdc
Collector-Emitter Voltage ($I_C = 100\text{mA}$)	BV_{CEO}	100			Vdc
Emitter-Base Voltage ($I_E = 10\text{mA}$)	BV_{EBO}	8.0			Vdc
Collector Cutoff Current ($V_{CB} = 120\text{V}$)	I_{CBO}			10	μA
Emitter Cutoff Current ($V_{EB} = 8.0\text{V}$)	I_{EBO}			10	μA
Collector Cutoff Current ($V_{CE} \neq 50\text{V}$)	I_{CEO}			0.1	μA
Current Gain ($V_{CE} = 5.0\text{V}$, $I_C = 5.0\text{A}$)	h_{FE}^*	40		120	
ON CHARACTERISTICS					
Current Gain ($V_{CE} = 5.0\text{V}$, $I_C = 10\text{A}$)	h_{FE}^*	10			
Collector Saturation Voltage ($I_C = 5.0\text{A}$, $I_B = 0.5\text{A}$)	$V_{CE(sat)}^*$			0.6	Vdc
Collector Saturation Voltage ($I_C = 10\text{A}$, $I_B = 1.0\text{A}$)	$V_{CE(sat)}^*$			1.5	Vdc
Base Saturation Voltage ($I_C = 5.0\text{A}$, $I_B = 0.5\text{A}$)	$V_{BE(sat)}^*$			1.2	Vdc
DYNAMIC CHARACTERISTICS					
Small Signal Current Gain ($V_{CE} = 10\text{V}$, $I_C = .05\text{A}$, $f = .001\text{ MHz}$)	$ h_{fe} $	40			
Collector Base Capacitance ($V_{CB} = 10\text{V}$, $I_C =$, $f = 1.0\text{MHz}$)	C_{ob}			200	pF
Turn-on Time ($V_{CC} = 20\text{V}$, $I_C = 5.0\text{A}$, $I_{B1} = 0.5\text{A}$, $I_{B2} = 0.5\text{A}$)	t_{on}			0.5	μs
Storage Time ($V_{CC} = 20\text{V}$, $I_C = 5.0\text{A}$, $I_{B1} = 0.5\text{A}$, $I_{B2} = 0.5\text{A}$)	t_s			1.2	μs
Fall Time ($V_{CC} = 20\text{V}$, $I_C = 5.0\text{A}$, $I_{B1} = 0.5\text{A}$, $I_{B2} = 0.5\text{A}$)	t_f			0.45	μs



**GENERAL
SEMICONDUCTOR
INDUSTRIES, INC.**

C²R

2N4071

NPN SWITCHING POWER TRANSISTORS

This unique device utilizes General Semiconductor Industries' C²R process (patent applied for) which describes a manufacturing technology that provides surface stabilization for high voltage operation and enhances long term reliability.

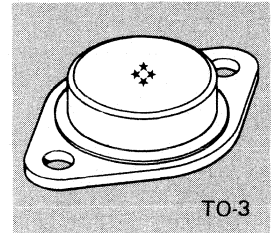

TO-3

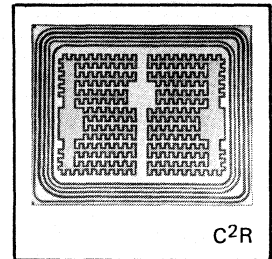

C²R

MAXIMUM RATINGS

RATINGS	SYMBOL	2N4071	UNIT
Collector-Base Voltage	V_{CBO}	200	Vdc
Collector-Emitter Voltage	V_{CEO}	150	Vdc
Emitter-Base Voltage	V_{EBO}	8.0	Vdc
Collector Current - Continuous	I_C	10	Adc
Base Current - Continuous	I_B	5.0	Adc
Total Power Dissipation @ $T_C=100^\circ\text{C}$	P_D	65	Watt
Thermal Resistance (Junction to Case)	θ_{J-C}	1.53	$^\circ\text{C}/\text{W}$
Junction Temperature	T_J	-65 to +200	$^\circ\text{C}$
Storage Temperature	T_{stg}	-65 to +200	$^\circ\text{C}$

4

**NPN SWITCHING
TRANSISTORS**

ELECTRICAL CHARACTERISTICS (T = 25°C unless otherwise specified)

CHARACTERISTIC	SYMBOL	MIN	TYP	MAX	UNIT
----------------	--------	-----	-----	-----	------

OFF CHARACTERISTICS

Collector-Base Voltage ($I_C=10mA$)	BV_{CBO}	200			Vdc
Collector-Emitter Voltage ($I_C=100mA$)	BV_{CEO}	150			Vdc
Emitter-Base Voltage ($I_E=10mA$)	BV_{EBO}	8.0			Vdc
Collector Cutoff Current ($V_{CB}=120V$)	I_{CBO}			10	μA
Emitter Cutoff Current ($V_{EB}=8.0V$)	I_{EBO}			10	μA
Collector Cutoff Current ($V_{CE}=50V$)	I_{CEO}			0.1	μA

ON CHARACTERISTICS

DC Current Gain ($V_{CE}=5V, I_C=5A$)	h_{FE}^*	40		120	
DC Current Gain ($V_{CE}=5V, I_C=10A$)	h_{FE}^*	10			
Collector Saturation Voltage ($I_C=5A, I_B=0.5A$)	$V_{CE(sat)}^*$			0.6	Vdc
Collector Saturation Voltage ($I_C=10A, I_B=1.0A$)	$V_{CE(sat)}^*$			1.5	Vdc
Base Saturation Voltage ($I_C=5A, I_B=0.5A$)	$V_{BE(sat)}^*$			1.2	Vdc

DYNAMIC CHARACTERISTICS

Small Signal Current Gain ($V_{CE}=10V, I_C=.05A, f=.001MHz$)	$ h_{fe} $	40			
Collector Base Capacitance ($V_{CB}=10V, f=1MHz$)	C_{ob}			200	pF
Turn-on Time ($V_{CC}=20V, I_C=5A, I_{B1}=0.5A, I_{B2}=0.5A$)	t_{on}			0.5	μs
Storage Time ($V_{CC}=20V, I_C=5A, I_{B1}=0.5A, I_{B2}=0.5A$)	t_s			1.2	μs
Fall Time ($V_{CC}=20V, I_C=5A, I_{B1}=0.5A, I_{B2}=0.5A$)	t_f			0.45	μs

*Pulse measurement conditions: Length = 300 μs , Duty Cycle \leq 2%.



GENERAL SEMICONDUCTOR INDUSTRIES, INC.

2N4150

NPN SILICON
HIGH POWER
TRANSISTORS

DIFFUSED SILICON PLANAR PASSIVATED TRANSISTORS

These devices are designed for use in high current switching applications. The latest technologies are used to offer the highest degree of reliability. JAN/JAN TX 2N4150 transistors to MIL-S-19500/394 are also available.

FEATURES

- Low Saturation Voltage
- Fast Switching
- Collector Current: 10 Amps Peak
- Low Leakage Current
- Low Drive Requirement

APPLICATIONS

- High Speed Switching
- Regulated Power Supplies
- Converters
- Inverters
- Wide Band Amplifiers

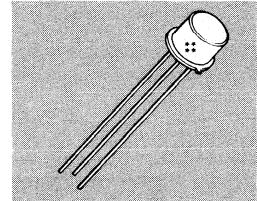

ABSOLUTE MAXIMUM RATINGS

Maximum Temperatures
 Storage Temperature -65°C to 200°C
 Operating Junction Temperature +200°C
 Lead Temperature (soldering, 60 second time limit) +300°C
 Maximum Power Dissipation
 Total Dissipation at 100°C Case Temperature 5 Watts
 (1) See Safe Operating Curves for derating
 Linear derating factor 50 mW/°C

Maximum Voltages and Current

	2N4150	JAN 2N4150
V _{CEO} Collector to Emitter Voltage	80 Volts	70 Volts
V _{CBO} Collector to Base Voltage	100 Volts	100 Volts
V _{EBO} Emitter to Base Voltage	5 Volts	7 Volts
I _C Continuous Collector Current	10 Amps	10 Amps

MECHANICAL CHARACTERISTICS

Case: TO-5 Package
 Weight: 1.8 grams (maximum)
 Leads: Gold Plated Kovar
 1. Emitter 2. Base 3. Collector
 Body marked with Logo ⋄ and type number

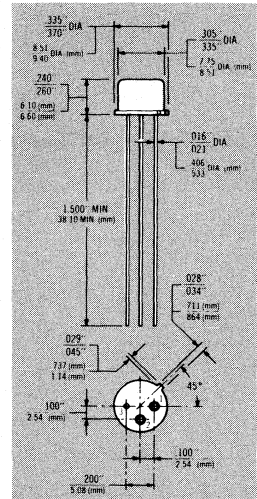

4
NPN SWITCHING
TRANSISTORS

ELECTRICAL CHARACTERISTICS (25° Case Temperature unless otherwise noted)

CHARACTERISTIC	SYMBOL	TEST CONDITIONS	2N4150		JAN2N4150		UNITS
			MIN	MAX	MIN	MAX	
Collector Cutoff Current	I _{CEO}	V _{CE} =60V, I _B =0		10	10	10	μ Amp
Collector Cutoff Current	I _{CEX}	V _{CE} =100V, V _{EB} =0.5V		10	10	10	μ Amp
Collector Cutoff Current	I _{CBO}	V _{CB} =60V, V _{BE} =0V		0.1	0.1	0.1	μ Amp
Emitter Cutoff Current	I _{EBO}	V _{BE} =5V, V _{CE} =0V		10		0.1	μ Amp
*DC Current Gain	h _{FE}	I _C = 5A, V _{CE} = 5V	40	120	40	120	
		I _C = 10A, V _{CE} = 5V		10		10	
		I _C = 1A, V _{CE} = 5V		50		50	
Collector to Base Breakdown Voltage	BV _{CBO}	I _C = 10 μA, I _E = 0	100		100		Volts
Collector to Emitter Breakdown Voltage	BV _{CEO}	I _C = 0.1A, I _B = 0	70		70		Volts
Emitter to Base Breakdown Voltage	BV _{EBO}	I _E = 10 μA, I _C = 0	7		7		Volts
*Collector Saturation Voltage	V _{CE(sat)}	I _C = 5A, I _B = 0.5A	0.6		0.6		Volts
		I _C = 10A, I _B = 1A	2.5		2.5		Volts
		I _C = 5A, I _B = 0.5A	1.5		1.5		Volts
*Base Saturation Voltage	V _{BE(sat)}	I _C = 10A, I _B = 1A	2.5		2.5		Volts

*Measurement Conditions = length ≤ 300 μsec; duty cycle ≤ 2%.



GENERAL SEMICONDUCTOR INDUSTRIES, INC.

2001 West Tenth Place, Tempe, Arizona 85281 • 602 968 3101 • TWX910-950 1942
 Mailing Address: P. O. Box 3078

GENERAL SEMICONDUCTOR INDUSTRIES, INC.

DYNAMIC CHARACTERISTICS

CHARACTERISTIC	SYMBOL	TEST CONDITIONS	2N4150		JAN 2N4150		UNITS
			MIN	MAX	MIN	MAX	
Pulse Delay Time	t_d	See Circuit #1		—	50		nSec
Pulse Rise Time	t_r	See Circuit #1		200	500		nSec
Pulse Storage Time	t_s	See Circuit #1		2.0	1.5		μ Sec
Pulse Fall Time	t_f	See Circuit #1		200	500		nSec
Collector Base Capacitance	C_{obc}	$V_{CB} = 10V, I_E = 0, f = 1 \text{ MHz}$		350	350		pF
High Frequency Small Signal	h_{fe}	$I_C = 200\text{mA}, V_{CE} = 10V, f = 10\text{MHz}$	1.5		1.5	7.5	

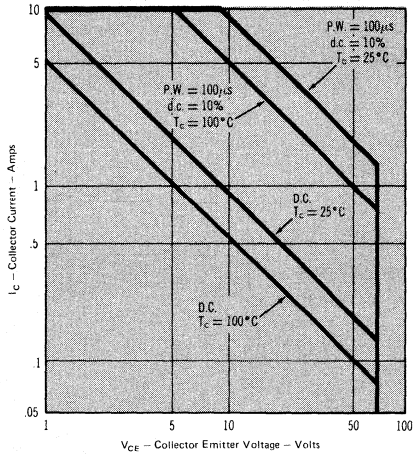

Figure 1 — Maximum Safe Operation Region

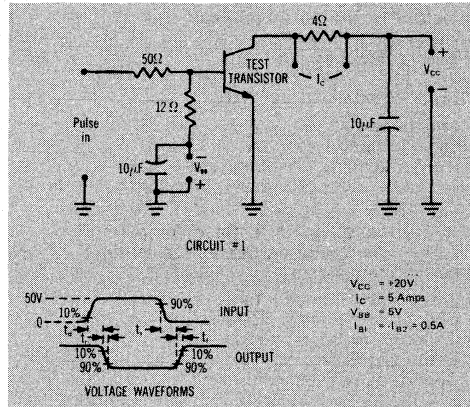

Figure 2 — Pulse Response Measurement Circuit

TYPICAL CHARACTERISTICS

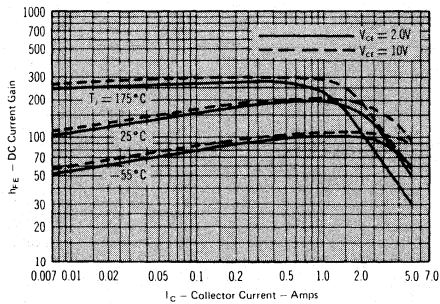

Figure 3 — Static Forward Current Transfer Ratio

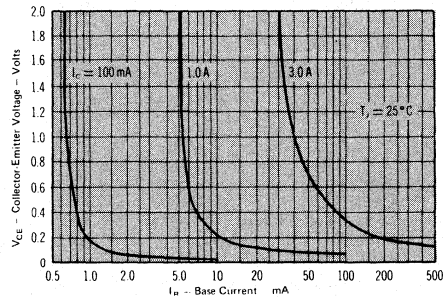

Figure 4 — Collector Saturation Region



GENERAL SEMICONDUCTOR INDUSTRIES, INC.

2001 West Tenth Place, Tempe, Arizona 85281 • 602.968.3101 • TWX910-950.1942
Mailing Address: P.O. Box 3078



GENERAL
SEMICONDUCTOR
INDUSTRIES, INC.

C²R[®]

2N4240

NPN SWITCHING POWER TRANSISTORS

This unique device utilizes General Semiconductor Industries' C²R process (patent applied for) which describes a manufacturing technology that provides surface stabilization for high voltage operation and enhances long term reliability.

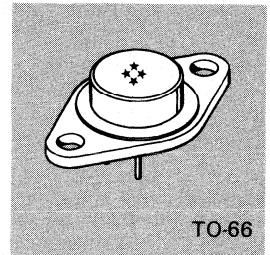

TO-66

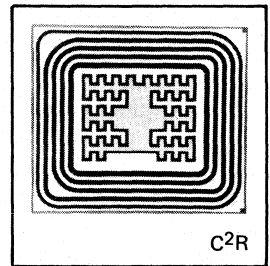

C²R

MAXIMUM RATINGS

RATINGS	SYMBOL	2N4240	UNIT
Collector-Base Voltage	V_{CBO}	500	Vdc
Collector-Emitter Voltage	V_{CEO}	300	Vdc
Emitter-Base Voltage	V_{EBO}	6.0	Vdc
Collector Current - Continuous	I_C	2.0	Adc
Base Current - Continuous	I_B	1.0	Adc
Total Power Dissipation @ $T_C=25^\circ\text{C}$	P_D	35	Watt
Junction Temperature	T_J	-65 to +200	$^\circ\text{C}$
Storage Temperature	T_{stg}	-65 to +200	$^\circ\text{C}$

4

NPN SWITCHING
TRANSISTORS

ELECTRICAL CHARACTERISTICS (T = 25°C unless otherwise specified)

CHARACTERISTIC	SYMBOL	MIN	TYP	MAX	UNIT
----------------	--------	-----	-----	-----	------

OFF CHARACTERISTICS

Collector-Emitter Sustaining Voltage ($I_C=200\text{mA}$)	$BV_{CEO}(\text{sus})$	300			Vdc
Emitter Cutoff Current ($V_{EB}=6.0\text{V}$)	I_{EBO}			0.5	mA
Collector Cutoff Current ($V_{CE}=150\text{V}$)	I_{CEO}			5.0	mA
Collector Cutoff Current ($V_{CE}=450\text{V}$, $V_{BE}=1.5\text{V}$) ($V_{CE}=300\text{V}$, $V_{BE}=1.5\text{V}$, $T_C=150^\circ\text{C}$)	I_{CEX}			2.0 5.0	mA

ON CHARACTERISTICS

DC Current Gain ($V_{CE}=2.0\text{V}$, $I_C=0.75\text{A}$)	h_{FE}^*	10		100	
Collector Saturation Voltage ($I_C=0.75\text{A}$, $I_B=75\text{mA}$)	$V_{CE}(\text{sat})^*$			1.0	Vdc
Base Saturation Voltage ($I_C=0.75\text{A}$, $I_B=75\text{mA}$)	$V_{BE}(\text{sat})^*$			1.8	Vdc

DYNAMIC CHARACTERISTICS

Current-Gain - Bandwidth Product ($I_C=200\text{mA}$, $V_{CE}=10\text{V}$, $f=5.0\text{MHz}$)	f_T	15			MHz
Rise Time ($V_{CC}=200\text{V}$, $I_C=0.75\text{A}$, $I_{B1}=75\text{mA}$, $I_{B2}=75\text{mA}$)	t_r			0.5	μs
Storage Time ($V_{CC}=200\text{V}$, $I_C=0.75\text{A}$, $I_{B1}=75\text{mA}$, $I_{B2}=75\text{mA}$)	t_s			6.0	μs
Fall Time ($V_{CC}=200\text{V}$, $I_C=0.75\text{A}$, $I_{B1}=75\text{mA}$, $I_{B2}=75\text{mA}$)	t_f			3.0	μs

*Pulse measurement conditions: Length = 300 μs , Duty Cycle \leq 2%.



**GENERAL
SEMICONDUCTOR
INDUSTRIES, INC.**

**2N4863
2N4864**

SILICON NPN TRANSISTORS

These double diffused, epitaxial collector devices are oxide passivated. They are designed for use in switching and many amplifier applications. The latest technologies are used to provide optimum performance and the highest degree of reliability.

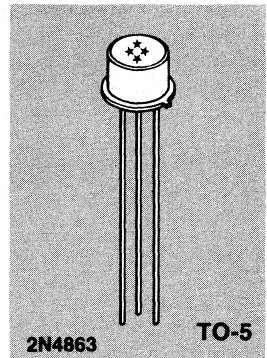
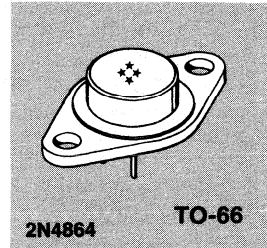

ABSOLUTE MAXIMUM RATINGS

RATINGS	SYMBOL	2N4863	2N4864	UNIT
Collector-Base Voltage	V_{CBO}	140	140	Vdc
Collector-Emitter Voltage	V_{CEO}	120	120	Vdc
Emitter-Base Voltage	V_{EBO}	8.0	8.0	Vdc
Collector Current — Continuous	I_C	2.0	2.0	Adc
Base Current — Continuous	I_B	0.5	0.5	Adc
Total Power Dissipation @ $T_C=100^\circ\text{C}$	P_D	4.0	16	Watt
Thermal Resistance (Junction to Case)	θ_{J-C}	25	6.25	$^\circ\text{C/W}$
Junction Temperature	T_J	-65 to +200	-65 to +200	$^\circ\text{C}$
Storage Temperature	T_{stg}	-65 to +200	-65 to +200	$^\circ\text{C}$

4
NPN SWITCHING
TRANSISTORS

ELECTRICAL CHARACTERISTICS (T = 25°C unless otherwise specified)

CHARACTERISTIC	SYMBOL	MIN	TYP	MAX	UNIT
OFF CHARACTERISTICS					
Collector-Base Voltage ($I_C = 1.0 \text{ mA}$)	BV_{CBO}	140			Vdc
Collector-Emitter Voltage ($I_C = 10 \text{ mA}$)	BV_{CEO}	120			Vdc
Emitter-Base Voltage ($I_E = 10 \text{ ua}$)	BV_{EBO}	8.0			Vdc
Collector Cutoff Current ($V_{CB} = 60V$)	I_{CBO}			0.1	μA
Emitter Cutoff Current ($V_{EB} = 8.0V$)	I_{EBO}			10	μA
Collector Cutoff Current ($V_{CE} = 60V$)	I_{CEO}			10	μA
Collector Cutoff Current ($V_{CE} = 140V, V_{EB} = 0.5V$)	I_{CEX}			10	μA
ON CHARACTERISTICS					
DC Current Gain ($V_{CE} = 5.0V, I_C = 0.5A$)	h_{FE}^*	50		150	
DC Current Gain ($V_{CE} = 5.0V, I_C = 2.0A$)	H_{FE}^*	15			
Collector Saturation Voltage ($I_C = 2.0A, I_B = 0.2A$)	$V_{CE(sat)}^*$			1.5	Vdc
Collector Saturation Voltage ($I_C = 500mA, I_B = 50mA$)	$V_{CE(sat)}^*$			0.2	Vdc
Base Saturation Voltage ($I_C = 500mA, V_{CE} = 5.0V$)	$V_{BE(on)}^*$			1.2	Vdc
DYNAMIC CHARACTERISTICS					
Small Signal Current Gain ($V_{CE} = 10V, I_C = 0.1A, f = 10MHz$)	$ h_{fe} $	5.0			
Collector Base Capacitance ($V_{CB} = 10V, I_C = 0, f = 1.0MHz$)	C_{ob}			50	pF
Rise Time ($V_{CC} = 30V, I_C = 1.0A, I_{B1} = 0.1A, I_{B2} = 0.1A$)	t_r			.15	μs
Storage Time ($V_{CC} = 30V, I_C = 1.0A, I_{B1} = 0.1A, I_{B2} = 0.1A$)	t_s			1.5	μs
Fall Time ($V_{CC} = 30V, I_C = 1.0A, I_{B1} = 0.1A, I_{B2} = 0.1A$)	t_f			.20	μs



GENERAL
SEMICONDUCTOR
INDUSTRIES, INC.

C²R[®]

2N5050
2N5051
2N5052

NPN SWITCHING POWER TRANSISTORS

This unique series utilizes General Semiconductor Industries' C²R process (patent applied for) which describes a manufacturing technology that provides surface stabilization for high voltage operation and enhances long term reliability.

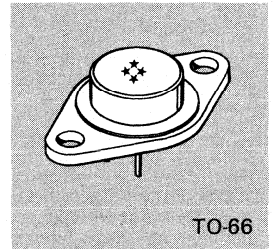

TO-66

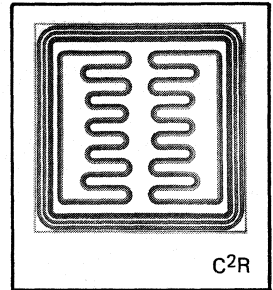

C²R

MAXIMUM RATINGS

RATINGS	SYMBOL	2N5050	2N5051	2N5052	UNIT
Collector-Base Voltage	V_{CBO}	125	150	200	Vdc
Collector-Emitter Voltage	V_{CEO}	125	150	200	Vdc
Emitter-Base Voltage	V_{EBO}	6.0			Vdc
Collector Current - Continuous	I_C	2.0			Adc
Base Current - Continuous	I_B	1.0			Adc
Total Power Dissipation @ $T_C=25^\circ\text{C}$	P_D	40			Watt
Thermal Resistance (Junction to Case)	θ_{J-C}	3.76 MAX			$^\circ\text{C/W}$
Junction Temperature	T_J	-65 to +175			$^\circ\text{C}$
Storage Temperature	T_{stg}	-65 to +200			$^\circ\text{C}$

4

NPN SWITCHING
TRANSISTORS

ELECTRICAL CHARACTERISTICS (T = 25°C unless otherwise specified)

CHARACTERISTIC	SYMBOL	MIN	TYP	MAX	UNIT
----------------	--------	-----	-----	-----	------

OFF CHARACTERISTICS

Collector-Emitter Sustaining Voltage ($I_C=200\text{mA}$ dc, $I_B=0$)	2N5050 2N5051 2N5052	$V_{CEO}(\text{sus})$	125 150 200		Vdc
Emitter Cutoff Current ($V_{EB}=6.0\text{V}$ dc, $I_C=0$)		I_{EBO}		0.1	mA
Collector Cutoff Current ($V_{CE}=62.5\text{V}$) ($V_{CE}=75\text{V}$) ($V_{CE}=100\text{V}$)	2N5050 2N5051 2N5052	I_{CEO}		0.1 0.1 0.1	mA
Collector Cutoff Current ($V_{CE}=\text{Rated } V_{CEO}$, $V_{EB}(\text{off})=1.5\text{V}$ dc) ($V_{CE}=\text{Rated } V_{CEO}$, $V_{EB}(\text{off})=1.5\text{V}$ dc, $T_C=150^\circ\text{C}$)		I_{CEX}		0.5 5.0	mA

ON CHARACTERISTICS

DC Current Gain ($V_{CE}=5.0\text{V}$, $I_C=0.75\text{A}$ dc)		h_{FE}^*	25	100	
DC Current Gain ($V_{CE}=5.0\text{V}$, $I_C=1.0\text{A}$ dc)		h_{FE}^*	25		
DC Current Gain ($V_{CE}=5.0\text{V}$, $I_C=2.0\text{A}$ dc)		h_{FE}^*	5.0		
Collector Saturation Voltage ($I_C=0.75\text{A}$, $I_B=0.1\text{A}$ dc)		$V_{CE}(\text{sat})^*$		1.0	Vdc
Collector Saturation Voltage ($I_C=2.0\text{A}$, $I_B=0.4\text{A}$ dc)		$V_{CE}(\text{sat})^*$		5.0	Vdc
Base-Emitter On Voltage ($I_C=0.75\text{A}$, $I_B=5.0\text{V}$ dc)		$V_{BE}(\text{on})^*$		1.2	Vdc

DYNAMIC CHARACTERISTICS

Current-Gain - Bandwidth Product ($I_C=250\text{mA}$, $V_{CE}=10\text{V}$, $f=5.0\text{MHz}$)		f_T	10		MHz
Small Signal Current Gain ($V_{CE}=10\text{V}$, $I_C=250\text{mA}$, $f=1.0\text{KHz}$)		$ h_{fe} $	25		
Collector Base Capacitance ($V_{CB}=10\text{V}$, $I_E=0$, $f=100\text{KHz}$)		C_{ob}		250	pF
Rise Time ($V_{CC}=120\text{V}$, $I_C=750\text{mA}$, $I_{B1}=100\text{mA}$, $I_{B2}=100\text{mA}$, $R_L=150$ ohms)		t_r		300	ns
Storage Time ($V_{CC}=120\text{V}$, $I_C=750\text{mA}$, $I_{B1}=100\text{mA}$, $I_{B2}=100\text{mA}$, $R_L=150$ ohms)		t_s		3.5	μs
Fall Time ($V_{CC}=120\text{V}$, $I_C=750\text{mA}$, $I_{B1}=100\text{mA}$, $I_{B2}=100\text{mA}$, $R_L=150$ ohms)		t_f		1.2	μs

*Pulse measurement conditions: Length = 300 μs , Duty Cycle $\leq 2\%$.



**GENERAL
SEMICONDUCTOR
INDUSTRIES, INC.**

C²R

2N5074

NPN SWITCHING POWER TRANSISTORS

This unique device utilizes General Semiconductor Industries' C²R process (patent applied for) which describes a manufacturing technology that provides surface stabilization for high voltage operation and enhances long term reliability.

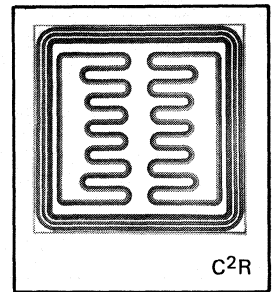
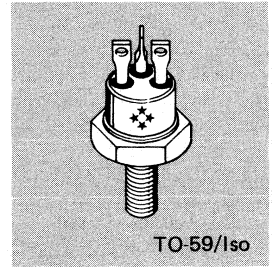

MAXIMUM RATINGS

RATINGS	SYMBOL	2N5074	UNIT
Collector-Base Voltage	V_{CBO}	200	Vdc
Collector-Emitter Voltage	V_{CEO}	200	Vdc
Emitter-Base Voltage	V_{EBO}	6.0	Vdc
Collector Current - Continuous	I_C	3.0	Adc
Base Current - Continuous	I_B	0.3	Adc
Junction Temperature	T_J	-65 to +200	°C
Storage Temperature	T_{stg}	-65 to +200	°C

4

NPN SWITCHING
TRANSISTORS

ELECTRICAL CHARACTERISTICS (T = 25°C unless otherwise specified)

CHARACTERISTIC	SYMBOL	MIN	TYP	MAX	UNIT
----------------	--------	-----	-----	-----	------

OFF CHARACTERISTICS

Collector-Emitter Sustaining Voltage ($I_C=25\text{mA}$)	BV_{CEO} (sus)	200			Vdc
Emitter Cutoff Current ($V_{EB}=6.0\text{V}$, $I_C=0$)	I_{EBO}			1.0	mA
Emitter Cutoff Current ($V_{EB}=5.0\text{V}$, $I_C=0$)	I_{EBO}			0.01	mA
Collector Cutoff Current ($V_{CE}=150\text{V}$)	I_{CEO}			0.01	mA
Collector Cutoff Current ($V_{CE}=200\text{V}$, $V_{BE}=0$, $T_C=150^\circ\text{C}$) ($V_{CE}=200\text{V}$, $V_{BE}=0$)	I_{CEX}			1.0 0.25	mA μA

ON CHARACTERISTICS

DC Current Gain ($V_{CE}=5.0\text{V}$, $I_C=3.0\text{A}$)	h_{FE}^*	10			
DC Current Gain ($V_{CE}=5.0\text{V}$, $I_C=0.5\text{A}$)	h_{FE}^*	30		110	
DC Current Gain ($V_{CE}=5.0\text{V}$, $I_C=0.5\text{A}$, $T_C= -55^\circ\text{C}$)	h_{FE}^*	12			
Collector Saturation Voltage ($I_C=3.0\text{A}$, $I_B=0.3\text{A}$)	$V_{CE}(\text{sat})^*$			2.0	Vdc
Base-Emitter Voltage ($I_C=3.0\text{A}$, $V_{CE}=5.0\text{V}$)	V_{BE}^*			2.2	Vdc
Base Saturation Voltage ($I_C=3.0\text{A}$, $I_B=0.3\text{A}$)	$V_{BE}(\text{sat})^*$			2.2	Vdc

DYNAMIC CHARACTERISTICS

Small Signal Current Gain ($V_{CE}=10\text{V}$, $I_C=100\text{mA}$, $f=20\text{MHz}$)	$ h_{fe} $	2.0			
Small Signal Current Gain ($V_{CE}=10\text{V}$, $I_C=250\text{mA}$, $f=1.0\text{KHz}$)	$ h_{fe} $	30			
Collector Base Capacitance ($V_{CB}=10\text{V}$, $I_C=0$, $f=1.0\text{MHz}$)	C_{ob}			100	pF

*Pulse measurement conditions: Length = 300 μs , Duty Cycle \leq 2%.



**GENERAL
SEMICONDUCTOR
INDUSTRIES, INC.**

**C²R[®]
2N5075
2N5076
2N5077**

NPN SWITCHING POWER TRANSISTORS

This unique series utilizes General Semiconductor Industries' C²R process (patent applied for) which describes a manufacturing technology that provides surface stabilization for high voltage operation and enhances long term reliability.

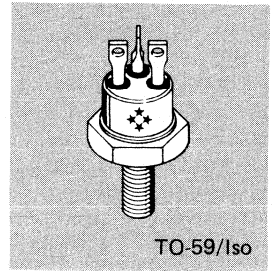

TO-59/Iso

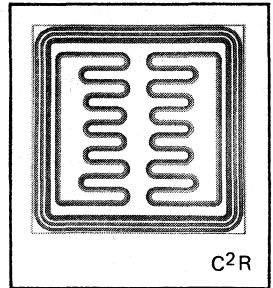

C²R

MAXIMUM RATINGS

RATINGS	SYMBOL	2N5075	2N5076	2N5077	UNIT
Collector-Base Voltage	V_{CBO}	200	250	250	Vdc
Collector-Emitter Voltage	V_{CEO}	200	250	250	Vdc
Emitter-Base Voltage	V_{EBO}	6.0			Vdc
Collector Current - Continuous	I_C	3.0			Adc
Base Current - Continuous	I_B	0.3			Adc
Total Power Dissipation @ $T_C=100^\circ\text{C}$	P_D	40			Watt
Thermal Resistance (Junction to Case)	θ_{J-C}	2.5			$^\circ\text{C}/\text{W}$
Junction Temperature	T_J	-65 to +200			$^\circ\text{C}$
Storage Temperature	T_{stg}	-65 to +200			$^\circ\text{C}$

ELECTRICAL CHARACTERISTICS (T = 25°C unless otherwise specified)

CHARACTERISTIC		SYMBOL	MIN	TYP	MAX	UNIT
----------------	--	--------	-----	-----	-----	------

OFF CHARACTERISTICS

Collector-Emitter Voltage ($I_C=25mA$)	2N5075 2N5076 2N5077	V_{CEO}	200 250 250			Vdc
Collector Cutoff Current ($V_{EB}=5V$)		I_{EBO}			10	μA
Emitter Cutoff Current ($V_{EB}=6V$)		I_{EBO}			1000	μA
Collector Cutoff Current ($V_{CE}=200V$) ($V_{CE}=250V$) ($V_{CE}=250V$)	2N5075 2N5076 2N5077	I_{CEX}			0.25	μA
Collector Cutoff Current ($V_{CE}=150V$)		I_{CEO}			10	μA

ON CHARACTERISTICS

DC Current Gain ($V_{CE}=5V$, $I_C=500mA$)	2N5075 2N5077	h_{FE}^*	90		250	
DC Current Gain ($V_{CE}=5V$, $I_C=3A$)	2N5075 2N5076 2N5077	h_{FE}^*	15 10 15			
DC Current Gain ($V_{CE}=5V$, $I_C=500mA$)		h_{FE}^*	30		110	
Collector Saturation Voltage ($I_C=3A$, $I_B=.3A$)		$V_{CE(sat)}^*$			2.0	Vdc
Base Saturation Voltage ($I_C=3A$, $I_B=.3A$)		$V_{BE(sat)}^*$			2.2	Vdc
Base Emitter Voltage ($I_C=3A$, $V_{CE}=5V$)		$V_{BE(on)}^*$			2.2	Vdc

DYNAMIC CHARACTERISTICS

Small Signal Current Gain ($V_{CE}=10V$, $I_C=100mA$, $f=20MHz$)		$ h_{fe} $	2.0			
Collector Base Capacitance ($V_{CB}=10V$, $I_C=0$, $f=1.0MHz$)		C_{ob}			100	pF

*Pulse measurement conditions: Length = 300 μs , Duty Cycle \leq 2%.



GENERAL SEMICONDUCTOR INDUSTRIES, INC.

2N5148
2N5150

DIFFUSED SILICON EPITAXIAL PASSIVATED TRANSISTOR

These devices are designed for use in power amplifiers and high speed switching applications. The latest technologies are used to offer the highest degree of reliability.

NPN SILICON HIGH POWER TRANSISTORS

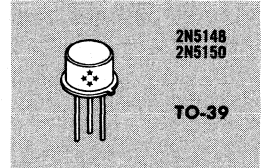

2N5148
2N5150

TO-39

FEATURES

- Low Saturation Voltage
- Fast Switching
- Low Leakage Current
- Isolated Collector
2N4998, 2N5000

APPLICATIONS

- High Frequency Inverters
- Converters
- Linear Amplifiers
- High Speed Switching
Regulated Power Supplies
- RF Power Amplifiers

ABSOLUTE MAXIMUM RATINGS

	2N5148	2N5150
Collector to Emitter Voltage	V_{CE0} 80 Volts	
Collector to Base Voltage	V_{CB0} 100 Volts	
Emitter to Base Voltage	V_{EB0} 6 Volts	
Collector Current — Continuous	I_C 2 Amps	
— Peak	I_C (Peak) 5 Amps	
Base Current — Continuous	I_B 1 Amp	
Total Device Dissipation, @ $T_C = 50^\circ C$	P_D 30 Watts	6 Watts
Linear Derating Factor	.2W/ $^\circ C$.04W/ $^\circ C$
Operating Junction and Storage Temperature Range	T_J, T_{stg} -65 $^\circ C$ to +200 $^\circ C$	

MECHANICAL CHARACTERISTICS

Case: 2N5148, 2N5150 — TO-39

1. Emitter 2. Base 3. Collector
Body marked with Logo and type number

ELECTRICAL CHARACTERISTICS (25 $^\circ$ Case Temperature unless otherwise noted)

CHARACTERISTIC	SYMBOL	TEST CONDITIONS	2N5148		2N5150		UNITS
			MIN	MAX	MIN	MAX	
Collector to Emitter Breakdown Voltage	BV_{CE0}	* $I_C = 100\text{ mA}, I_B = 0$	80		80		Volts
Collector Cutoff Current	I_{CE0}	$V_{CE} = 40V, I_B = 0$		50		50	μAmp
	I_{CES}	$V_{CE} = 60V, V_{BE} = 0V$		1.0		1.0	μAmp
		$V_{CE} = 100V, V_{BE} = 0V$		1.0		1.0	mA
Emitter Cutoff Current	I_{EBO}	$V_{EB} = 5V, I_C = 0$		1.0		1.0	μAmp
		$V_{EB} = 6V, I_C = 0$		1.0		1.0	mA
DC Current Gain	h_{FE}	* $I_C = 50\text{ mA}, V_{CE} = 5V$	20		50		
		* $I_C = 1A, V_{CE} = 5V$	30	90	70	200	
		* $I_C = 2A, V_{CE} = 5V$	15		30		
		* $I_C = 1A, V_{CE} = 5V @ T_C = -55^\circ C$	15		35		
Collector Saturation Voltage	$V_{CE(sat)}$	* $I_C = 1A, I_B = 0.1A$		0.46		0.46	Volts
		* $I_C = 3A, I_B = 0.6A$		5.0		5.0	Volts
Base Emitter Saturation Voltage	$V_{BE(sat)}$	* $I_C = 1A, I_B = 0.1A$		1.2		1.2	Volts
		* $I_C = 2A, I_B = 0.2A$		1.5		1.5	Volts
Turn-on Time	t_{on}	See Figure 1		0.1		0.1	$\mu\text{sec.}$
Turn-off Time	t_{off}	See Figure 1		0.8		1.2	$\mu\text{sec.}$
Collector Base Capacitance	C_{ob}	$V_{CB} = 10V, I_E = 0, f = 1\text{ MHz}$		70		70	pF
High Frequency Current Gain	$ h_{fe} $	$V_{CE} = 5V, I_C = 0.2A, f = 20\text{ MHz}$	2.5			3	

* Pulse Test: Pulse length $\leq 300\mu\text{sec.}$ duty cycle $\leq 2\%$. Measured 1/8" from body using separate current carrying and voltage sensing contacts for each lead.



GENERAL SEMICONDUCTOR INDUSTRIES, INC.

2001 West Tenth Place, Tempe, Arizona 85281 • 602-968-3101 • TWX910-950-1942
Mailing Address: P.O. Box 3078

4
NPN SWITCHING
TRANSISTORS

GENERAL SEMICONDUCTOR INDUSTRIES, INC.

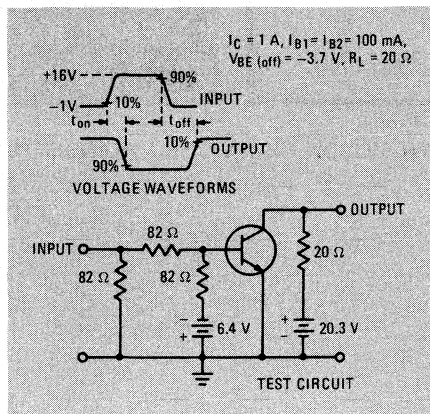

FIGURE 1 — Switching Circuit

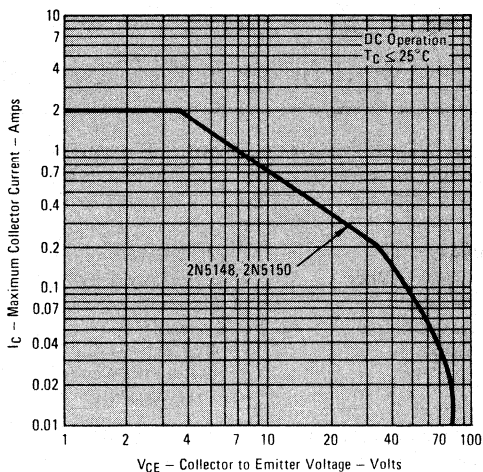

FIGURE 2 — Maximum Safe Operating Region

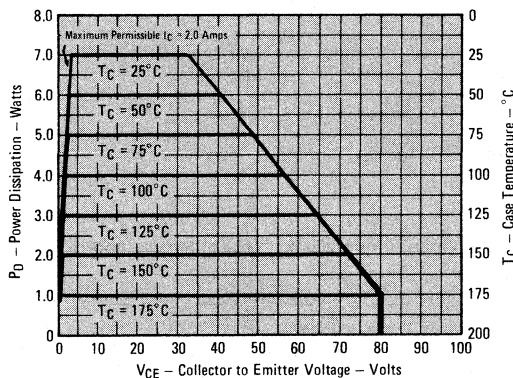

FIGURE 3 — Dissipation Derating Curve (2N5148, 2N5150)

TYPICAL CHARACTERISTICS

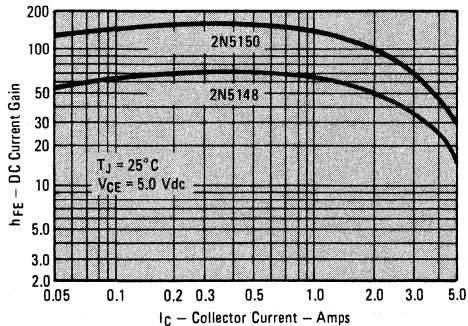

FIGURE 4 — DC Current Gain

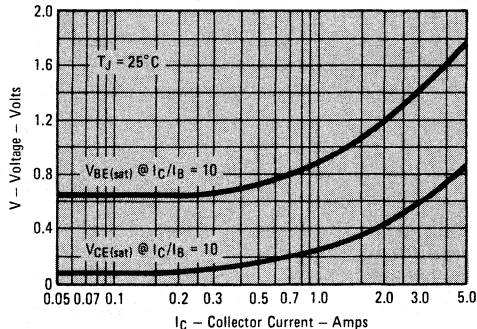

FIGURE 5 — "On" Voltages



**GENERAL
SEMICONDUCTOR
INDUSTRIES, INC.**

C²R
2N5218

NPN SWITCHING POWER TRANSISTORS

This unique device utilizes General Semiconductor Industries' C²R process (patent applied for) which describes a manufacturing technology that provides surface stabilization for high voltage operation and enhances long term reliability.

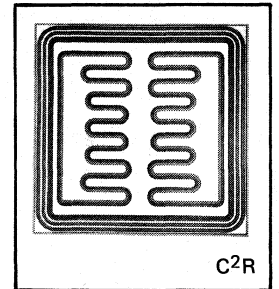
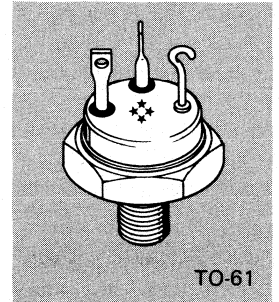

MAXIMUM RATINGS

RATINGS	SYMBOL	2N5218	UNIT
Collector-Base Voltage	V_{CBO}	220V	Vdc
Collector-Emitter Voltage	V_{CEO}	200V	Vdc
Emitter-Base Voltage	V_{EBO}	8V	Vdc
Collector Current - Continuous	I_C	10	Adc
Base Current - Continuous	I_B	1.0	Adc
Total Power Dissipation @ $T_C=100^\circ\text{C}$	P_D	50	Watt
Thermal Resistance (Junction to Case)	θ_{J-C}	2.0	$^\circ\text{C}/\text{W}$
Storage Temperature	T_{stg}	-65 to +200	$^\circ\text{C}$

4

NPN SWITCHING
TRANSISTORS

ELECTRICAL CHARACTERISTICS (T = 25°C unless otherwise specified)

CHARACTERISTIC	SYMBOL	MIN	TYP	MAX	UNIT
Collector-Base Voltage ($I_C=10\mu A$)	BV_{CBO}	220			Vdc
Collector-Emitter Sustaining Voltage ($I_C=200mA$)	$BV_{CEO(sus)}$	200			Vdc
Emitter-Base Voltage ($I_E=10\mu A$)	BV_{EBO}	8			Vdc
Collector Cutoff Current ($V_{CB}=100V$)	I_{CBO}			0.5	μA
Emitter Cutoff Current ($V_{EB}=8V$)	I_{EBO}			10	μA
Collector Cutoff Current ($V_{CE}=200V$)	I_{CEO}			100	μA
Collector-Emitter Cutoff Current ($V_{CE}=220V, V_{BE}=-1.5V, T_C=150^\circ C$) ($V_{CE}=220V, V_{BE}=-1.5V$)	I_{CEX}			2.0 10	mA μA

ON CHARACTERISTICS

DC Current Gain ($V_{CE}=5V, I_C=5A$)	h_{FE}^*	15		120	
DC Current Gain ($V_{CE}=5V, I_C=5A, T_C=-55^\circ C$)	h_{FE}^*	10			
DC Current Gain ($V_{CE}=5.0V, I_C=0.5A$)	h_{FE}^*	75		300	
DC Current Gain ($V_{CE}=5.0V, I_C=10A$)	h_{FE}^*	5			
Collector Saturation Voltage ($I_C=5A, I_B=0.5A$)	$V_{CE(sat)}^*$			0.6	Vdc
Collector Saturation Voltage ($I_C=10A, I_B=2.0A$)	$V_{CE(sat)}^*$			5.0	Vdc
Base-Emitter Voltage ($I_C=5A, V_{CE}=5V$)	V_{BE}^*			1.2	Vdc
Base Saturation Voltage ($I_C=5.0A, I_B=0.5A$)	$V_{BE(sat)}^*$			1.5	Vdc

DYNAMIC CHARACTERISTICS

Small Signal Current Gain ($V_{CE}=10V, I_C=1.0A, f=10MHz$)	$ h_{fe} $	4			
Small Signal Current Gain ($V_{CE}=10V, I_C=50mA, f=1.0KHz$)	$ h_{fe} $	40			
Collector Base Capacitance ($V_{CB}=10V, I_E=0, f=1.0MHz$)	C_{ob}			200	pF
Turn-on Time ($V_{CC}=20V, I_C=1.0A, I_{B1}=0.1A, I_{B2}=0.1A$)	t_{on}			0.6	μs
Turn-off Time ($V_{CC}=20V, I_C=1.0A, I_{B1}=0.1A, I_{B2}=0.1A$)	t_{off}			5.5	μs
Rise Time ($V_{CC}=20V, I_C=1.0A, I_{B1}=0.1A, I_{B2}=0.1A$)	t_r			0.6	μs
Storage Time ($V_{CC}=20V, I_C=1.0A, I_{B1}=0.1A, I_{B2}=0.1A$)	t_s			4.5	μs
Fall Time ($V_{CC}=20V, I_C=1.0A, I_{B1}=0.1A, I_{B2}=0.1A$)	t_f			1.0	μs

*Pulse measurement conditions: Length = 300 μs , Duty Cycle \leq 2%.



GENERAL
SEMICONDUCTOR
INDUSTRIES, INC.

C²R[®]

2N5237

NPN SWITCHING POWER TRANSISTORS

This unique device utilizes General Semiconductor Industries' C²R process (patent applied for) which describes a manufacturing technology that provides surface stabilization for high voltage operation and enhances long term reliability.

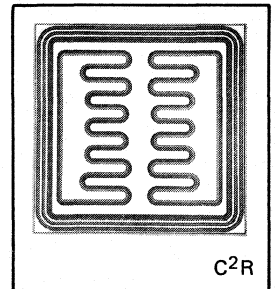
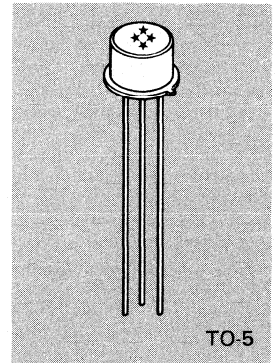

4

NPN SWITCHING
TRANSISTORS

MAXIMUM RATINGS

RATINGS	SYMBOL	2N5237	UNIT
Collector-Base Voltage	V_{CBO}	150	Vdc
Collector-Emitter Voltage	V_{CEO}	120	Vdc
Emitter-Base Voltage	V_{EBO}	7	Vdc
Collector Current - Continuous	I_C	10	Adc
Base Current - Continuous	I_B	3	Adc
Total Power Dissipation @ $T_C=100^\circ\text{C}$	P_D	5	Watt
Junction Temperature	T_J	-65 to +200	$^\circ\text{C}$
Storage Temperature	T_{stg}	-65 to +200	$^\circ\text{C}$

ELECTRICAL CHARACTERISTICS (T = 25°C unless otherwise specified)

CHARACTERISTIC	SYMBOL	MIN	TYP	MAX	UNIT
----------------	--------	-----	-----	-----	------

OFF CHARACTERISTICS

Collector-Base Voltage ($I_C=10\mu A$)	BV_{CBO}	150			Vdc
Collector-Emitter Voltage ($I_C=0.1A$)	BV_{CEO}	120			Vdc
Emitter-Base Voltage ($I_E=10\mu A$)	BV_{EBO}	7			Vdc
Collector Cutoff Current ($V_{CB}=80V$)	I_{CBO}			0.1	μA
Emitter Cutoff Current ($V_{EB}=5V$)	I_{EBO}			0.1	μA
Collector Cutoff Current ($V_{CE}=110V$)	I_{CEO}			10	μA
Collector-Emitter Cutoff Current ($V_{CE}=150V, V_{BE} = -0.5V$) ($V_{CE}=130V, V_{BE} = -0.5V, T_C=150^\circ C$)	I_{CEX}			10 100	μA

ON CHARACTERISTICS

DC Current Gain ($V_{CE}=5V, I_C=5A$)	h_{FE}^*	40		120	
DC Current Gain ($V_{CE}=5V, I_C=10A$)	h_{FE}^*	10			
DC Current Gain ($V_{CE}=5V, I_C=1A$)	h_{FE}^*	50			
Collector Saturation Voltage ($I_C=5A, I_B=0.5A$)	$V_{CE(sat)}^*$			0.6	Vdc
Collector Saturation Voltage ($I_C=10A, I_B=1A$)	$V_{CE(sat)}^*$			2.5	Vdc
Base Saturation Voltage ($I_C=5A, I_B=0.5A$)	$V_{BE(sat)}^*$			1.5	Vdc
Base Saturation Voltage ($I_C=10A, I_B=1A$)	$V_{BE(sat)}^*$			2.5	Vdc

DYNAMIC CHARACTERISTICS

Small Signal Current Gain ($V_{CE}=5V, I_C=50mA, f=1KHz$)	$ h_{fe} $	40		160	
Small Signal Current Gain ($V_{CE}=10V, I_C=0.2A, f=10MHz$)	$ h_{fe} $	1.5		7.5	
Collector Base Capacitance ($V_{CE}=10V, I_C=0, f=1MHz$)	C_{ob}			350	pF
Delay Time ($V_{CC}=20V, I_C=5A, I_{B1}=0.5A, I_{B2}=0.5A$)	t_d			50	ns
Rise Time ($V_{CC}=20V, I_C=5A, I_{B1}=0.5A, I_{B2}=0.5A$)	t_r			500	ns
Storage Time ($V_{CC}=20V, I_C=5A, I_{B1}=0.5A, I_{B2}=0.5A$)	t_s			1.5	μs
Fall Time ($V_{CC}=20V, I_C=5A, I_{B1}=0.5A, I_{B2}=0.5A$)	t_f			500	ns

*Pulse measurement conditions: Length = 300 μs , Duty Cycle \leq 2%.



**GENERAL
SEMICONDUCTOR
INDUSTRIES, INC.**

C²R

**2N5387
2N5388**

NPN SWITCHING POWER TRANSISTORS

This unique series utilizes General Semiconductor Industries' C²R process (patent applied for) which describes a manufacturing technology that provides surface stabilization for high voltage operation and enhances long term reliability.

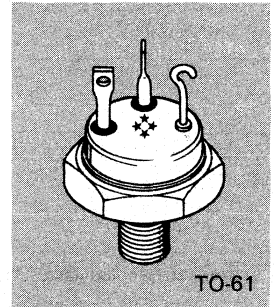

TO-61

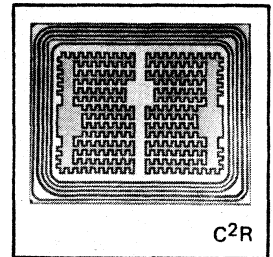

C²R

MAXIMUM RATINGS

RATINGS	SYMBOL	2N5387	2N5388	UNIT
Collector-Base Voltage	V_{CBO}	200	250	Vdc
Collector-Emitter Voltage	V_{CEO}	200	250	Vdc
Emitter-Base Voltage	V_{EBO}	10		Vdc
Collector Current - Continuous	I_C	7.5		Adc
Base Current - Continuous	I_B	3		Adc
Total Power Dissipation @ $T_C=100^\circ\text{C}$	P_D	100		Watt
Total Power Dissipation @ $T_A=25^\circ\text{C}$	P_D	3.5		Watt
Thermal Resistance (Junction to Case)	θ_{J-C}	1.0		$^\circ\text{C}/\text{W}$
Thermal Resistance (Junction to Ambient)	θ_{J-A}	50		$^\circ\text{C}/\text{W}$
Junction Temperature	T_J	-65 to +200		$^\circ\text{C}$
Storage Temperature	T_{stg}	-65 to +200		$^\circ\text{C}$

4

NPN SWITCHING
TRANSISTORS

ELECTRICAL CHARACTERISTICS (T = 25°C unless otherwise specified)

CHARACTERISTIC	SYMBOL	MIN	TYP	MAX	UNIT
----------------	--------	-----	-----	-----	------

OFF CHARACTERISTICS

Collector-Emitter Voltage ($I_C=30\text{mA}$)	2N5387 2N5388	V_{CE0}	200 250		Vdc
Emitter Cutoff Current ($V_{EB}=10\text{V}$)		I_{EBO}		1	mA
Emitter Cutoff Current ($V_{EB}=8\text{V}$)		I_{EBO}		100	μA
Collector Cutoff Current ($V_{CE}=180\text{V}$) ($V_{CE}=225\text{V}$)	2N5387 2N5388	I_{CEO}		30 30	mA
Collector Cutoff Current ($V_{CE}=100\text{V}$, $V_{BE}=0$, $T_C=150^\circ\text{C}$) ($V_{CE}=125\text{V}$, $V_{BE}=0$, $T_C=150^\circ\text{C}$)	2N5387 2N5388	I_{CES}		10 10	mA
Collector Cutoff Current ($V_{CE}=180\text{V}$, $V_{BE}=0$) ($V_{CE}=225\text{V}$, $V_{BE}=0$)	2N5387 2N5388	I_{CES}		1.0 1.0	mA

ON CHARACTERISTICS

DC Current Gain ($V_{CE}=5\text{V}$, $I_C=7\text{A}$)	h_{FE}^*	5			
DC Current Gain ($V_{CE}=5\text{V}$, $I_C=5\text{A}$)	h_{FE}^*	15			
DC Current Gain ($V_{CE}=5\text{V}$, $I_C=2\text{A}$)	h_{FE}^*	25		100	
Collector Saturation Voltage ($I_C=7\text{A}$, $I_B=1.4\text{A}$)	$V_{CE}(\text{sat})^*$			2.2	Vdc
Collector Saturation Voltage ($I_C=5\text{A}$, $I_B=1\text{A}$)	$V_{CE}(\text{sat})^*$			2	Vdc
Base Emitter Voltage ($I_C=7\text{A}$, $V_{CE}=5\text{V}$)	V_{BE}^*			2.5	Vdc

DYNAMIC CHARACTERISTICS

Small Signal Current Gain ($V_{CE}=10\text{V}$, $I_C=1\text{A}$, $f=10\text{MHz}$)	$ h_{fe} $	1.5			
Common-Emitter Small Signal Current Gain ($V_{CE}=10\text{V}$, $I_C=1\text{A}$, $f=1\text{kHz}$)	$ h_{fe} $	20			

*Pulse measurement conditions: Length = 300 μs , Duty Cycle \leq 2%.



**GENERAL
SEMICONDUCTOR
INDUSTRIES, INC.**

C²R

2N5389

NPN SWITCHING POWER TRANSISTORS

This unique device utilizes General Semiconductor Industries' C²R process (patent applied for) which describes a manufacturing technology that provides surface stabilization for high voltage operation and enhances long term reliability.

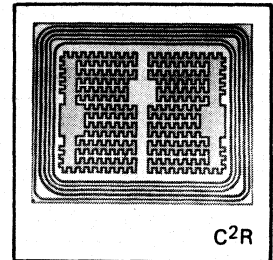
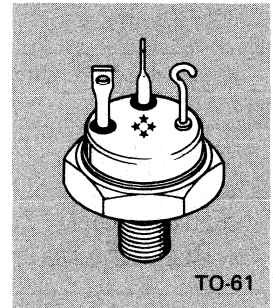

4

**NPN SWITCHING
TRANSISTORS**

MAXIMUM RATINGS

RATINGS	SYMBOL	2N5389	UNIT
Collector-Base Voltage	V_{CBO}	300	Vdc
Collector-Emitter Voltage	V_{CEO}	300	Vdc
Emitter-Base Voltage	V_{EBO}	10	Vdc
Collector Current - Continuous	I_C	7.5	Adc
Base Current - Continuous	I_B	3	Adc
Total Power Dissipation @ $T_C=100^\circ\text{C}$	P_D	100	Watt
Total Power Dissipation @ $T_A=25^\circ\text{C}$	P_D	3.5	Watt
Thermal Resistance (Junction to Case)	θ_{J-C}	1.0	$^\circ\text{C/W}$
Thermal Resistance (Junction to Ambient)	θ_{J-A}	50	$^\circ\text{C/W}$
Junction Temperature	T_J	-65 to +200	$^\circ\text{C}$
Storage Temperature	T_{stg}	-65 to +200	$^\circ\text{C}$

ELECTRICAL CHARACTERISTICS (T = 25°C unless otherwise specified)

CHARACTERISTIC	SYMBOL	MIN	TYP	MAX	UNIT
----------------	--------	-----	-----	-----	------

OFF CHARACTERISTICS

Collector-Emitter Voltage ($I_C=30\text{mA}$)	V_{CE0}	300			Vdc
Emitter Cutoff Current ($V_{EB}=10\text{V}$)	I_{EBO}			1.0	mA
Emitter Cutoff Current ($V_{CE}=8\text{V}$)	I_{EBO}			100	μA
Collector Cutoff Current ($V_{CE}=270\text{V}$)	I_{CEO}			30	mA
Collector Cutoff Current ($V_{CE}=150\text{V}$, $V_{BE}=0$, $T_C=150^\circ\text{C}$)	I_{CES}			10	mA
Collector Cutoff Current ($V_{CE}=270\text{V}$, $V_{BE}=0$)	I_{CES}			1.0	mA

ON CHARACTERISTICS

DC Current Gain ($V_{CE}=5\text{V}$, $I_C=7\text{A}$)	h_{FE}^*	5			
DC Current Gain ($V_{CE}=5\text{V}$, $I_C=5\text{A}$)	h_{FE}^*	15			
DC Current Gain ($V_{CE}=5\text{V}$, $I_C=2\text{A}$)	h_{FE}^*	25		100	
Collector Saturation Voltage ($I_C=7\text{A}$, $I_B=1.4\text{A}$)	$V_{CE(\text{sat})}^*$			2.2	Vdc
Collector Saturation Voltage ($I_C=5\text{A}$, $I_B=1\text{A}$)	$V_{CE(\text{sat})}^*$			2	Vdc
Base Emitter Voltage ($I_C=7\text{A}$, $V_{CE}=5\text{V}$)	V_{BE}^*			2.5	Vdc

DYNAMIC CHARACTERISTICS

Small Signal Current Gain ($V_{CE}=10\text{V}$, $I_C=1\text{A}$, $f=10\text{MHz}$)	$ h_{fe} $	1.5			
---	------------	-----	--	--	--

*Pulse measurement conditions: Length = 300 μs , Duty Cycle $\leq 2\%$.



GENERAL
SEMICONDUCTOR
INDUSTRIES, INC.

C²R

2N5541
2N5542

NPN SWITCHING POWER TRANSISTORS

This unique series utilizes General Semiconductor Industries' C²R process (patent applied for) which describes a manufacturing technology that provides surface stabilization for high voltage operation and enhances long term reliability.

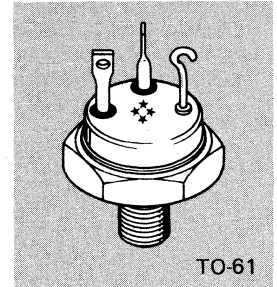
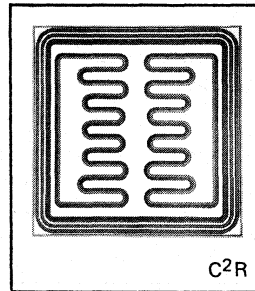
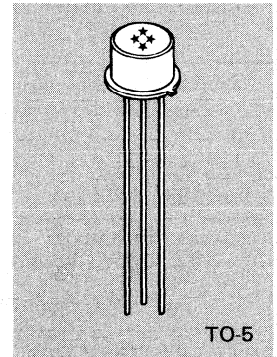

4

NPN SWITCHING
TRANSISTORS

MAXIMUM RATINGS

RATINGS	SYMBOL	2N5541	2N5542	UNIT
Collector-Base Voltage	V_{CBO}	175	175	Vdc
Collector-Emitter Voltage	V_{CEO}	130	130	Vdc
Emitter-Base Voltage	V_{EBO}	8.0	8.0	Vdc
Collector Current - Continuous	I_C	5.0	10A	Adc
Base Current - Continuous	I_B	1.0	2.0A	Adc
Total Power Dissipation @ $T_C=100^\circ\text{C}$	P_D	5.0	50	Watt
Junction Temperature	T_J	-65 to +200		$^\circ\text{C}$
Storage Temperature	T_{stg}	-65 to +200		$^\circ\text{C}$

ELECTRICAL CHARACTERISTICS (T = 25°C unless otherwise specified)

CHARACTERISTIC	SYMBOL	MIN	TYP	MAX	UNIT
----------------	--------	-----	-----	-----	------

OFF CHARACTERISTICS

Collector-Emitter Sustaining Voltage ($I_C=100mA$)	$BV_{CEO}(sus)$	130			Vdc
Collector Cutoff Current ($V_{CB}=100V$)	I_{CBO}			0.5	μA
Emitter Cutoff Current ($V_{EB}=8.0V$)	I_{EBO}			10	μA
Emitter Cutoff Current ($V_{EB}=5.0V$)	I_{EBO}			0.5	μA
Collector Cutoff Current ($V_{CE}=100V, V_{BE} = -0.5V, T_C=150^\circ C$) ($V_{CE}=175V, V_{BE} = -0.5V$)	I_{CEX}			100 10	μA

ON CHARACTERISTICS

DC Current Gain ($V_{CE}=5.0V, I_C=5.0A$)	h_{FE}^*	30		90	
Collector Saturation Voltage ($I_C=10A, I_B=1.0A$)	$V_{CE}(sat)^*$			2.5	Vdc
Collector Saturation Voltage ($I_C=5.0A, I_B=0.5A$)	2N5541 2N5542 $V_{CE}(sat)^*$			0.6 0.5	Vdc
Base Saturation Voltage ($I_C=10A, I_B=1.0A$)	$V_{BE}(sat)^*$			2.5	Vdc
Base Saturation Voltage ($I_C=5.0A, I_B=0.5A$)	2N5541 2N5542 $V_{BE}(sat)^*$			1.5 1.2	Vdc

DYNAMIC CHARACTERISTICS

Small Signal Current Gain ($V_{CE}=10V, I_C=0.2A, f=10MHz$) ($V_{CE}=10V, I_C=1.0A, f=10MHz$)	2N5541 2N5542 $ h_{fe} $	2.0 2.0			
Rise Time ($V_{CC}=20V, I_C=5.0A, I_{B1}=0.5A, I_{B2}=0.5A$)	t_r			0.5	μs
Storage Time ($V_{CC}=20V, I_C=5.0A, I_{B1}=0.5A, I_{B2}=0.5A$)	t_s			1.5	μs
Fall Time ($V_{CC}=20V, I_C=5.0A, I_{B1}=0.5A, I_{B2}=0.5A$)	t_f			0.5	μs

*Pulse measurement conditions: Length = 300 μs , Duty Cycle $\leq 2\%$.



**GENERAL
SEMICONDUCTOR
INDUSTRIES, INC.**

C²R

**2N5660
2N5661**

NPN SWITCHING POWER TRANSISTORS

This unique series utilizes General Semiconductor Industries' C²R process (patent applied for) which describes a manufacturing technology that provides surface stabilization for high voltage operation and enhances long term reliability.

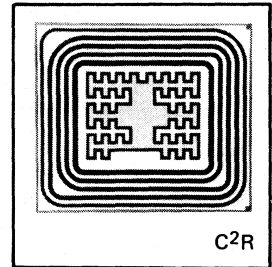
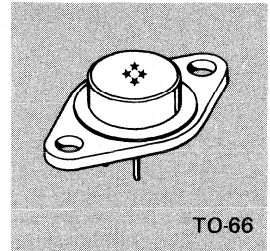

4

**NPN SWITCHING
TRANSISTORS**

MAXIMUM RATINGS

RATINGS	SYMBOL	2N5660	2N5661	UNIT
Collector-Base Voltage	V_{CBO}	250	400	Vdc
Collector-Emitter Voltage	V_{CEO}	200	300	Vdc
Emitter-Base Voltage	V_{EBO}	6.0		Vdc
Collector Current - Continuous	I_C	1.0		Adc
Base Current - Continuous	I_B	0.2		Adc
Total Power Dissipation @ $T_C=100^\circ\text{C}$	P_D	20		Watt
Thermal Resistance (Junction to Case)	θ_{J-C}	5.0		$^\circ\text{C/W}$
Junction Temperature	T_J	-65 to +200		$^\circ\text{C}$
Storage Temperature	T_{stg}	-65 to +200		$^\circ\text{C}$

ELECTRICAL CHARACTERISTICS (T = 25°C unless otherwise specified)

CHARACTERISTIC		SYMBOL	MIN	TYP	MAX	UNIT
----------------	--	--------	-----	-----	-----	------

OFF CHARACTERISTICS

Collector-Base Voltage ($I_C=1.0mA$)	2N5660 2N5661	V_{CBO}	250 400			Vdc
Collector-Emitter Voltage ($I_C=20mA$)	2N5660 2N5661	V_{CEO}	200 300			Vdc
Collector-Emitter Breakdown Voltage ($I_C=10mA$, $R_{BE}=100\Omega$)	2N5660 2N5661	V_{CE}	250 400			Vdc
Emitter Cutoff Current ($V_{EB}=6.0V$)		I_{EBO}			10	μA
Collector Cutoff Current ($V_{CE}=400V$)		I_{CEO}			1.0	μA
Collector Cutoff Current ($V_{CE}=250V$)		I_{CBS}			1.0	μA

ON CHARACTERISTICS

DC Current Gain ($V_{CE}=5.0V$, $I_C=1.0A$)	2N5660	h_{FE}^*	15			
DC Current Gain ($V_{CE}=5.0V$, $I_C=1.0A$)	2N5661	h_{FE}^*	15			
DC Current Gain ($V_{CE}=5.0V$, $I_C=500mA$)	2N5660 2N5661	h_{FE}^*	40 25		120 75	
Collector Saturation Voltage ($I_C=1.0A$, $I_B=0.1A$)		$V_{CE(sat)}^*$			0.4	Vdc
Base Saturation Voltage ($I_C=1.0A$, $I_B=0.1A$)		$V_{BE(sat)}^*$			1.2	Vdc

DYNAMIC CHARACTERISTICS

Small Signal Current Gain ($V_{CE}=5.0V$, $I_C=0.1A$, $f=10MHz$)		$ h_{fe} $	2.0			
Collector Base Capacitance ($V_{CB}=10V$, $f=1MHz$)		C_{ob}			60	pF
Turn-on Time ($V_{CC}=100V$, $I_C=500mA$, $I_{B1}=15mA$, $I_{B2}=15mA$)	2N5660	t_{on}			0.25	μs
Turn-off Time ($V_{CC}=100V$, $I_C=500mA$, $I_{B1}=15mA$, $I_{B2}=15mA$)	2N5660	t_{off}			0.85	μs
Turn-on Time ($V_{CC}=100V$, $I_C=500mA$, $I_{B1}=25mA$, $I_{B2}=25mA$)	2N5661	t_{on}			0.25	μs
Turn-off Time ($V_{CC}=100V$, $I_C=500mA$, $I_{B1}=25mA$, $I_{B2}=25mA$)	2N5661	t_{off}			1.20	μs

*Pulse measurement conditions: Length = 300 μs , Duty Cycle \leq 2%.



**GENERAL
SEMICONDUCTOR
INDUSTRIES, INC.**

C²R

**2N5662
2N5663**

NPN SWITCHING POWER TRANSISTORS

This unique series utilizes General Semiconductor Industries' C²R process (patent applied for) which describes a manufacturing technology that provides surface stabilization for high voltage operation and enhances long term reliability.

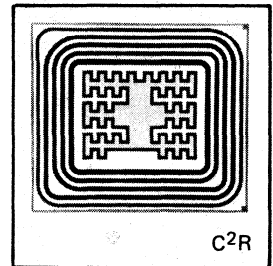
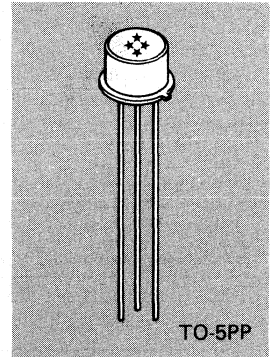

4

**NPN SWITCHING
TRANSISTORS**

MAXIMUM RATINGS

RATINGS	SYMBOL	2N5662	2N5663	UNIT
Collector-Base Voltage	V_{CBO}	250	400	Vdc
Collector-Emitter Voltage	V_{CEO}	200	300	Vdc
Emitter-Base Voltage	V_{EBO}	6.0		Vdc
Collector Current - Continuous	I_C	1.0		Adc
Base Current - Continuous	I_B	0.2		Adc
Total Power Dissipation @ $T_C=100^\circ\text{C}$	P_D	15		Watt
Thermal Resistance (Junction to Case)	θ_{J-C}	6.67		$^\circ\text{C/W}$
Junction Temperature	T_J	-65 to +200		$^\circ\text{C}$
Storage Temperature	T_{stg}	-65 to +200		$^\circ\text{C}$

ELECTRICAL CHARACTERISTICS (T = 25°C unless otherwise specified)

CHARACTERISTIC		SYMBOL	MIN	TYP	MAX	UNIT
----------------	--	--------	-----	-----	-----	------

OFF CHARACTERISTICS

Collector-Base Voltage ($I_C=1.0mA$)	2N5662 2N5663	V_{CBO}	250 400			Vdc
Collector-Emitter Voltage ($I_C=20mA$)	2N5662 2N5663	V_{CEO}	200 300			Vdc
Collector-Emitter Breakdown Voltage ($I_C=10mA$, $R_{BE}=100\Omega$)	2N5662 2N5663	V_{CER}	250 400			Vdc
Emitter Cutoff Current ($V_{EB}=6.0V$)		I_{EBO}			10	μA
Collector Cutoff Current ($V_{CE}=400V$)		I_{CEO}			1.0	μA
Collector Cutoff Current ($V_{CB}=250V$)		I_{CES}			1.0	μA

ON CHARACTERISTICS

DC Current Gain ($V_{CE}=5.0V$, $I_C=1.0A$)		h_{FE}^*	15			
DC Current Gain ($V_{CE}=5.0V$, $I_C=500mA$)	2N5662 2N5663	h_{FE}^*	40 25		120 75	
Collector Saturation Voltage ($I_C=1.0A$, $I_B=0.1A$)		$V_{CE(sat)}^*$			0.4	Vdc
Base Saturation Voltage ($I_C=1.0A$, $I_B=0.1A$)		$V_{BE(sat)}^*$			1.2	Vdc

DYNAMIC CHARACTERISTICS

Small Signal Current Gain ($V_{CE}=5.0V$, $I_C=0.1A$, $f=10MHz$)		$ h_{fe} $	2.0			
Collector Base Capacitance ($V_{CB}=10V$, $f=1MHz$)		C_{ob}			60	pF
Turn-on Time ($V_{CC}=30V$, $I_C=500mA$, $I_{B1}=15mA$, $I_{B2}=15mA$)	2N5662	t_{on}			0.25	μs
Turn-off Time ($V_{CC}=30V$, $I_C=500mA$, $I_{B1}=15mA$, $I_{B2}=15mA$)	2N5662	t_{off}			0.85	μs
Turn-on Time ($V_{CC}=30V$, $I_C=500mA$, $I_{B1}=25mA$, $I_{B2}=25mA$)	2N5663	t_{on}			0.25	μs
Turn-off Time ($V_{CC}=30V$, $I_C=500mA$, $I_{B1}=25mA$, $I_{B2}=25mA$)	2N5663	t_{off}			1.20	μs

*Pulse measurement conditions: Length = 300 μs , Duty Cycle \leq 2%.



**GENERAL
SEMICONDUCTOR
INDUSTRIES, INC.**

**2N5664
2N5665**

SILICON NPN TRANSISTORS

These double diffused, epitaxial collector devices are oxide passivated. They are designed for use in switching and many amplifier applications. The latest technologies are used to provide optimum performance and the highest degree of reliability.

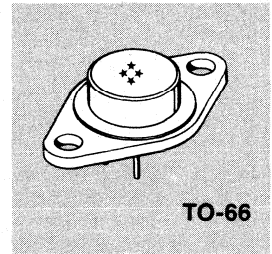

4

**NPN SWITCHING
TRANSISTORS**

ABSOLUTE MAXIMUM RATINGS

RATINGS	SYMBOL	2N5664	2N5665	UNIT
Collector-Base Voltage	V_{CBO}	250	400	Vdc
Collector-Emitter Voltage	V_{CEO}	200	300	Vdc
Emitter-Base Voltage	V_{EBO}	6.0	6.0	Vdc
Collector Current — Continuous	I_C	3.0	3.0	Adc
Base Current — Continuous	I_B	0.6	0.6	Adc
Total Power Dissipation @ $T_C=100^\circ\text{C}$	P_D	30	30	Watt
Thermal Resistance (Junction to Case)	θ_{J-C}	3.3	3.3	$^\circ\text{C}/\text{W}$
Junction Temperature	T_J	+200	+200	$^\circ\text{C}$
Storage Temperature	T_{stg}	-65 to +200	-65 to +200	$^\circ\text{C}$

ELECTRICAL CHARACTERISTICS (T = 25°C unless otherwise specified)

CHARACTERISTIC		SYMBOL	MIN	TYP	MAX	UNIT
OFF CHARACTERISTICS						
Collector-Base Voltage ($I_C=1.0\text{mA}$)	2N5664 2N5665	BV_{CBO}	250 400			Vdc
Collector-Emitter Voltage ($I_C=20\text{mA}$)	2N5664 2N5665	BV_{CEO}	200 300			Vdc
Collector-Emitter Breakdown Voltage ($I_C=10\text{mA}$, $R_{BE}=100\Omega$)	2N5664 2N5665	BV_{CER}	250 400			Vdc
Collector Cutoff Current ($V_{CB}=250\text{V}$)	2N5664	I_{CES}			1.0	μA
Emitter Cutoff Current ($V_{EB}=6.0\text{V}$)		I_{EBO}			10	μA
Collector Cutoff Current ($V_{CE}=400\text{V}$)	2N5665	I_{CES}			1.0	μA
ON CHARACTERISTICS						
Collector Saturation Voltage ($I_C=3.0\text{A}$, $I_B=0.3\text{A}$)		$V_{CE(\text{sat})}^*$			0.4	Vdc
Case Saturation Voltage ($I_C=3.0\text{A}$, $I_B=0.3\text{A}$)		$V_{BE(\text{sat})}^*$			1.2	Vdc
DYNAMIC CHARACTERISTICS						
Small Signal Current Gain ($V_{CE}=5.0\text{V}$, $I_C=0.5\text{A}$, $f=10\text{MHz}$)		$ h_{fe} $	2.0			
Collector Base Capacitance ($V_{CB}=10\text{V}$, $I_C=$, $f=1.0\text{MHz}$)		C_{ob}			125	pF
Turn-on Time ($V_{CC}=100\text{V}$, $I_C=1.0\text{A}$, $I_{B1}=30\text{mA}$, $I_{B2}=30\text{mA}$)	2N5664	t_{on}			0.25	μs
Turn-off Time ($V_{CC}=100\text{V}$, $I_C=1.0\text{A}$, $I_{B1}=30\text{mA}$, $I_{B2}=30\text{mA}$)	2N5664	t_{off}			1.50	μs
Turn-on Time ($V_{CC}=100\text{V}$, $I_C=1.0\text{A}$, $I_{B1}=50\text{mA}$, $I_{B2}=50\text{mA}$)	2N5665	t_{on}			0.25	μs
Turn-off Time ($V_{CC}=100\text{V}$, $I_C=1.0\text{A}$, $I_{B1}=50\text{mA}$, $I_{B2}=50\text{mA}$)	2N5665	t_{off}			2.0	μs

*Pulse Measurement Conditions: Length = 300 μs , Duty Cycle \leq 2%



GENERAL
SEMICONDUCTOR
INDUSTRIES, INC.

2N5666
2N5667

SILICON NPN TRANSISTORS

These double diffused, epitaxial collector devices are oxide passivated. They are designed for use in switching and many amplifier applications. The latest technologies are used to provide optimum performance and the highest degree of reliability.

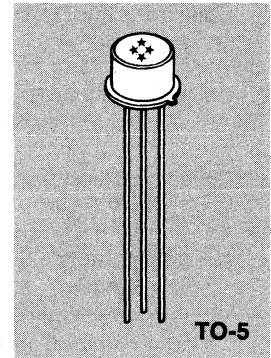

TO-5

4

NPN SWITCHING
TRANSISTORS

ABSOLUTE MAXIMUM RATINGS

RATINGS	SYMBOL	2N5666	2N5667	UNIT
Collector-Base Voltage	V_{CBO}	250	400	Vdc
Collector-Emitter Voltage	V_{CEO}	200	300	Vdc
Emitter-Base Voltage	V_{EBO}	6.0	6.0	Vdc
Collector Current — Continuous	I_C	3.0	3.0	Adc
Base Current — Continuous	I_B	0.6	0.6	Adc
Total Power Dissipation @ $T_C=100^\circ\text{C}$	P_D	15	15	Watt
Thermal Resistance (Junction to Case)	Θ_{J-C}	6.67	6.67	$^\circ\text{C/W}$
Junction Temperature	T_J	+200	+200	$^\circ\text{C}$
Storage Temperature	T_{stg}	-65 to +200	-65 to +200	$^\circ\text{C}$

ELECTRICAL CHARACTERISTICS (T = 25°C unless otherwise specified)

CHARACTERISTIC		SYMBOL	MIN	TYP	MAX	UNIT
OFF CHARACTERISTICS						
Collector-Base Voltage ($I_C=1.0\text{mA}$)	2N5666 2N5667	BV_{CBO}	250 400			Vdc
Collector-Emitter Voltage ($I_C=20\text{mA}$)	2N5666 2N5667	BV_{CEO}	200 300			Vdc
Collector-Emitter Breakdown Voltage ($I_C=10\text{mA}$, $R_{BE}=100\Omega$)	2N5666 2N5667	BV_{CER}	250 400			Vdc
Collector Cutoff Current ($V_{CB}=250\text{V}$)	2N5666	I_{CES}			1.0	μA
Emitter Cutoff Current ($V_{EB}=6.0\text{V}$)		I_{EBO}			10	μA
Collector Cutoff Current ($V_{CE}=400\text{V}$)		I_{CEO}			1.0	μA
ON CHARACTERISTICS						
DC Current Gain ($V_{CE}=5.0\text{V}$, $I_C=3.0\text{A}$)		h_{FE}^*	15			
DC Current Gain ($V_{CE}=5.0\text{V}$, $I_C=1.0\text{A}$)	2N5666	h_{FE}^*	40		120	
DC Current Gain ($V_{CE}=5.0\text{V}$, $I_C=1.0\text{A}$)	2N5667	h_{FE}^*	25		75	
Collector Saturation Voltage ($I_C=3.0\text{A}$, $I_B=0.6\text{A}$)		$V_{CE(sat)}^*$			0.4	Vdc
Base Saturation Voltage ($I_C=3.0\text{A}$, $I_B=0.6\text{A}$)		$V_{BE(sat)}^*$			1.2	Vdc
DYNAMIC CHARACTERISTICS						
Small Signal Current Gain ($V_{CE}=5.0\text{V}$, $I_C=0.1\text{A}$, $f=10\text{MHz}$)		$ h_{fe} $	2.0			
Collector Base Capacitance ($V_{CB}=10\text{V}$, $I_C=$, $f=1.0\text{MHz}$)		C_{ob}			125	pF
Turn-on Time ($V_{CC}=100\text{V}$, $I_C=1.0\text{A}$, $I_{B1}=30\text{mA}$, $I_{B2}=30\text{mA}$)	2N5666	t_{on}			0.25	μs
Turn-off Time ($V_{CC}=100\text{V}$, $I_C=1.0\text{A}$, $I_{B1}=30\text{mA}$, $I_{B2}=30\text{mA}$)	2N5666	t_{off}			1.50	μs
Turn-on Time ($V_{CC}=100\text{V}$, $I_C=1.0\text{A}$, $I_{B1}=50\text{mA}$, $I_{B2}=50\text{mA}$)	2N5667	t_{on}			0.25	μs
Turn-off Time ($V_{CC}=100\text{V}$, $I_C=1.0\text{A}$, $I_{B1}=50\text{mA}$, $I_{B2}=50\text{mA}$)	2N5667	t_{off}			2.00	μs



GENERAL
SEMICONDUCTOR
INDUSTRIES, INC.

2N5732

SILICON NPN TRANSISTORS

These double diffused, epitaxial collector devices are oxide passivated. They are designed for use in switching and many amplifier applications. The latest technologies are used to provide optimum performance and the highest degree of reliability.

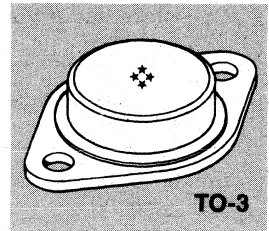

4

NPN SWITCHING
TRANSISTORS

ABSOLUTE MAXIMUM RATINGS

XR13

RATINGS	SYMBOL	2N5732	UNIT
Collector-Base Voltage	V_{CBO}	100	Vdc
Collector-Emitter Voltage	V_{CEO}	80	Vdc
Emitter-Base Voltage	V_{EBO}	6.0	Vdc
Collector Current — Continuous	I_C	20	Adc
Base Current — Continuous	I_B	4.0	Adc
Total Power Dissipation @ $T_C = 50^\circ\text{C}$	P_D	75	Watt
Thermal Resistance (Junction to Case)	θ_{J-C}	2.0	$^\circ\text{C}/\text{w}$
Junction Temperature	T_J	-65 to +200	$^\circ\text{C}$
Storage Temperature	T_{stg}	-65 to +200	$^\circ\text{C}$

ELECTRICAL CHARACTERISTICS (T = 25°C unless otherwise specified)

CHARACTERISTIC	SYMBOL	MIN	TYP	MAX	UNIT
OFF CHARACTERISTICS					
Collector-Base Voltage ($I_C = 1.0\text{mA}$)	BV_{CBO}	100	150		Vdc
Collector-Emitter Voltage ($I_C = 100\text{mA}$)	BV_{CEO}	80	100		Vdc
Emitter-Base Voltage ($I_E = 1.0\text{mA}$)	BV_{EBO}	6.0	8.0		Vdc
Emitter Cutoff Current ($V_{EB} = 5.0\text{V}$)	I_{EBO}		1.0ua	10	μA
Collector Cutoff Current ($V_{CE} = 100\text{V}$)	I_{CES}		100	1.0	mA
Collector Cutoff Current ($V_{CE} = 80\text{V}$ @ $TC = 150^\circ\text{C}$)	I_{CES}		250	1.0	mA
ON CHARACTERISTICS					
DC Current Gain ($V_{CE} = 2.0\text{V}$, $I_C = 5.0\text{A}$)	h_{FE}^*	30	80	300	
DC Current Gain ($V_{CE} = 5.0\text{V}$, $I_C = 20\text{A}$)	h_{FE}^*	5.0	20		
Collector Saturation Voltage ($I_C = 10\text{A}$, $I_B = 1.0\text{A}$)	$V_{CE(\text{sat})}^*$		0.6	1.2	Vdc
Base Saturation Voltage ($I_C = 10\text{A}$, $I_B = 1.0\text{A}$)	$V_{BE(\text{sat})}^*$		1.0	1.5	Vdc
DYNAMIC CHARACTERISTICS					
Small Signal Current Gain ($V_{CE} = 5.0\text{V}$, $I_C = 0.5\text{A}$, $f = 20\text{MHz}$)	$ h_{fe} $	1.5	2.0		
Collector Base Capacitance ($V_{CB} = 10\text{V}$, $I_C =$, $f = 1\text{MHz}$)	C_{ob}		175	350	pF
Delay Time ($V_{CC} = 40\text{V}$, $I_C = 5.0\text{A}$, $I_{B1} = 0.5\text{A}$, $I_{B2} = 0.5\text{A}$)	t_d		0.03	0.1	μs
Rise Time ($V_{CC} = 40\text{V}$, $I_C = 5.0\text{A}$, $I_{B1} = 0.5\text{A}$, $I_{B2} = 0.5\text{A}$)	t_r		0.20	0.3	μs
Storage Time ($V_{CC} = 40\text{V}$, $I_C = 5.0\text{A}$, $I_{B1} = 0.5\text{A}$, $I_{B2} = 0.5\text{A}$)	t_s		1.50	3.0	μs
Fall Time ($V_{CC} = 40\text{V}$, $I_C = 5.0\text{A}$, $I_{B1} = 0.5\text{A}$, $I_{B2} = 0.5\text{A}$)	t_f		0.40	0.6	μs

*Pulse Measurement Conditions: Length = 300 μs , Duty Cycle \leq 2%



GENERAL
SEMICONDUCTOR
INDUSTRIES, INC.

2N6032

SILICON NPN TRANSISTORS

These double diffused, epitaxial collector devices are oxide passivated. They are designed for use in switching and many amplifier applications. The latest technologies are used to provide optimum performance and the highest degree of reliability.

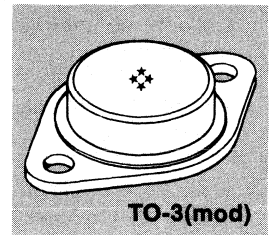

ABSOLUTE MAXIMUM RATINGS

RATINGS	SYMBOL	2N6032	UNIT
Collector-Base Voltage	V_{CBO}	120	Vdc
Collector-Emitter Voltage	V_{CEO}	90	Vdc
Emitter-Base Voltage	V_{EBO}	7.0	Vdc
Collector Current — Continuous	I_C	50	Adc
Base Current — Continuous	I_B	10	Adc
Total Power Dissipation @ $T_C=100^\circ\text{C}$	P_D	80	Watt
Thermal Resistance (Junction to Case)	Θ_{c}	1.25	$^\circ\text{C}/\text{W}$
Junction Temperature	T_J	- 65 to +200	$^\circ\text{C}$
Storage Temperature	T_{stg}	- 65 to +200	$^\circ\text{C}$

4

NPN SWITCHING
TRANSISTORS

ELECTRICAL CHARACTERISTICS (T = 25°C unless otherwise specified)

CHARACTERISTIC	SYMBOL	MIN	TYP	MAX	UNIT
OFF CHARACTERISTICS					
Collector-Base Voltage ($I_C=10mA$)	BV_{CBO}	120			Vdc
Collector-Emitter Voltage ($I_C = 0.2A$)	BV_{CEO}	90			Vdc
Emitter-Base Voltage ($I_E=10mA$)	BV_{EBO}	7.0			Vdc
Collector-Emitter Breakdown Voltage ($I_C=200mA, V_{EB}=1.5V$)	BV_{CEX}	120			Vdc
Emitter Cutoff Current ($V_{EB} = 7.0 V$)	I_{EBO}			10	MA
Collector Emitter Cutoff Current ($V_{CE} = 110V, V_{EB} = 1.5V$)	I_{CEX}			12	MA
ON CHARACTERISTICS					
DC Current Gain ($V_{CE}=2.6V, I_C=50A$)	h_{FE}^*	10		50	
Collector Saturation Voltage ($I_C=50A, I_B=5.0A$)	$V_{CE(sat)}^*$			1.3	Vdc
Base Saturation Voltage ($I_C=50A, I_B=5.0A$)	$V_{BE(sat)}^*$			2.0	Vdc
DYNAMIC CHARACTERISTICS					
Small Signal Current Gain ($V_{CE}=10V, I_C=2.0A, f=5.0MHz$)	$ h_{fe} $	10			
Collector Base Capacitance ($V_{CB}=10V, I_C=0, f=1.0MHz$)	C_{ob}			800	pF
Rise Time ($V_{CC}=30V, I_C=50A, I_{B1}=5.0A, I_{B2}=5.0A$)	t_r			1.0	μs
Storage Time ($V_{CC}=30V, I_C=50A, I_{B1}=5.0A, I_{B2}=5.0A$)	t_s			1.5	μs
Fall Time ($V_{CC}=30V, I_C=50A, I_{B1}=5.0A, I_{B2}=5.0A$)	t_f			0.5	μs

*Pulse Measurement Conditions: Length = 300 μs , Duty Cycle \leq 2%



GENERAL
SEMICONDUCTOR
INDUSTRIES, INC.

2N6033

SILICON NPN TRANSISTORS

These double diffused, epitaxial collector devices are oxide passivated. They are designed for use in switching and many amplifier applications. The latest technologies are used to provide optimum performance and the highest degree of reliability.

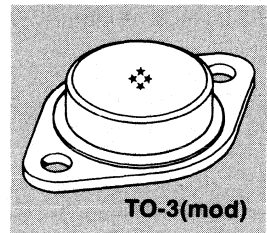

4

NPN SWITCHING
TRANSISTORS

ABSOLUTE MAXIMUM RATINGS

RATINGS	SYMBOL	2N6033	UNIT
Collector-Base Voltage	V_{CB0}	150	Vdc
Collector-Emitter Voltage	V_{CE0}	120	Vdc
Emitter-Base Voltage	V_{EB0}	7.0	Vdc
Collector Current — Continuous	I_C	40	Adc
Base Current — Continuous	I_B	10	Adc
Total Power Dissipation @ $T_C=100^\circ\text{C}$	P_D	80	Watt
Thermal Resistance (Junction to Case)	Θ_{-c}	1.25	$^\circ\text{C/W}$
Junction Temperature	T_J	-65 to +200	$^\circ\text{C}$
Storage Temperature	T_{STG}	-65 to +200	$^\circ\text{C}$

ELECTRICAL CHARACTERISTICS (T = 25°C unless otherwise specified)

CHARACTERISTIC	SYMBOL	MIN	TYP	MAX	UNIT
OFF CHARACTERISTICS					
Collector-Base Voltage ($I_C = 10\text{mA}$)	BV_{CBO}	150			Vdc
Collector-Emitter Voltage ($I_C = 0.2\text{A}$)	BV_{CEO}	120			Vdc
Emitter-Base Voltage ($I_E = 10\text{mA}$)	BV_{EBO}	7.0			Vdc
Collector-Emitter Breakdown Voltage ($I_C = 200\text{mA}$, $V_{EB} = 1.5\text{V}$)	BV_{CEX}	150			Vdc
Emitter Cutoff Current ($V_{EB} = 7.0\text{V}$)	I_{EBO}			10	MA
Collector Cutoff Current ($V_{CE} = 135$, $V_{BE} = -1.5\text{V}$)	I_{CEX}			10	mA
ON CHARACTERISTICS					
DC Current Gain ($V_{CE} = 2.0\text{V}$, $I_C = 40\text{A}$)	h_{FE}^*	10		50	
Collector Saturation Voltage ($I_C = 40\text{A}$, $I_B = 4.0\text{A}$)	$V_{CE(sat)}^*$			1.0	Vdc
Base Saturation Voltage ($I_C = 40\text{A}$, $I_B = 4.0\text{A}$)	$V_{BE(sat)}^*$			2.0	Vdc
DYNAMIC CHARACTERISTICS					
Small Signal Current Gain ($V_{CE} = 10\text{V}$, $I_C = 2.0\text{A}$, $f = 5.0\text{MHz}$)	$ h_{fe} $	10			
Collector Base Capacitance ($V_{CB} = 10\text{V}$, $f = 1.0\text{MHz}$)	C_{ob}			800	pF
Rise Time ($V_{CC} = 30\text{V}$, $I_C = 40\text{A}$, $I_{B1} = 4.0\text{A}$, $I_{B2} = 4.0\text{A}$)	t_r			1.0	μs
Storage Time ($V_{CC} = 30\text{V}$, $I_C = 40\text{A}$, $I_{B1} = 4.0\text{A}$, $I_{B2} = 4.0\text{A}$)	t_s			1.5	μs
Fall Time ($V_{CC} = 30\text{V}$, $I_C = 40\text{A}$, $I_{B1} = 4.0\text{A}$, $I_{B2} = 4.0\text{A}$)	t_f			0.5	μs

*Pulse Measurement Conditions: Length = 300 μs , Duty Cycle \leq 2%



**GENERAL
SEMICONDUCTOR
INDUSTRIES, INC.**

C²R

2N6077
2N6078

NPN SWITCHING POWER TRANSISTORS

This unique series utilizes General Semiconductor Industries' C²R process (patent applied for) which describes a manufacturing technology that provides surface stabilization for high voltage operation and enhances long term reliability.

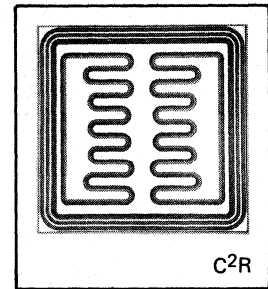
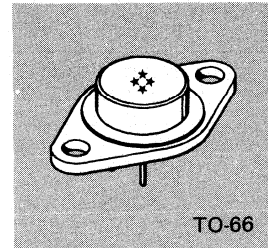

4

NPN SWITCHING
TRANSISTORS

MAXIMUM RATINGS

RATINGS	SYMBOL	2N6077	2N6078	UNIT
Collector-Base Voltage	V_{CBO}	300	275	Vdc
Collector-Emitter Voltage	V_{CEX}	300	275	Vdc
Emitter-Base Voltage	V_{EBO}	6	6	Vdc
Collector Current - Continuous	I_C	7.0	7.0	Adc
Base Current - Continuous	I_B	4.0	4.0	Adc
Total Power Dissipation @ $T_C=100^\circ\text{C}$	P_D	25.7	25.7	Watt
Junction Temperature	$T_J(\text{MAX})$	200	200	$^\circ\text{C}$
Storage Temperature	T_{stg}	-65 to +200	-65 to +200	$^\circ\text{C}$

ELECTRICAL CHARACTERISTICS (T = 25°C unless otherwise specified)

CHARACTERISTIC		SYMBOL	MIN	TYP	MAX	UNIT
Collector-Emitter Voltage ($I_C=0.2A$)	2N6077 2N6078	V_{CEO}	275 250			Vdc
Emitter Cutoff Current ($V_{EB}=6V$)		I_{EBO}			1.0	mA
Collector Cutoff Current ($V_{CE}=250V, I_B=0$)	2N6077	I_{CEO}			2.0	mA
Collector Cutoff Current ($V_{CE}=250V, V_{BE} = -1.5V, T_C=125^\circ C$)	2N6077	I_{CEV}			8.0	mA
($V_{CE}=250V, V_{BE} = -1.5V$)	2N6077				5.0	
Collector Cutoff Current ($V_{CE}=250V, V_{BE} = -1.5V, T_C=125^\circ C$)	2N6078	I_{CEV}			0.2	mA
($V_{CE}=250V, V_{BE} = -1.5V$)	2N6078				0.05	

ON CHARACTERISTICS

DC Current Gain ($V_{CE}=1.0V, I_C=1.2A$)		h_{FE}^*	12		70	
Collector Saturation Voltage ($I_C=3A, I_B=0.6A$)	2N6077	$V_{CE(sat)}^*$			1.0	Vdc
Collector Saturation Voltage ($I_C=5A, I_B=1.0A$)	2N6078	$V_{CE(sat)}^*$			3.0	Vdc
Base Saturation Voltage ($I_C=3A, I_B=0.6A$)	2N6077	$V_{BE(sat)}^*$			1.9	Vdc
Base Saturation Voltage ($I_C=5A, I_B=1.0A$)	2N6078	$V_{BE(sat)}^*$			2.0	Vdc

DYNAMIC CHARACTERISTICS

Small Signal Current Gain ($V_{CE}=10V, I_C=0.2A, f=1.0MHz$)		$ h_{fe} $	1.0			
Rise Time ($V_{CC}=250V, I_C=1.2A, I_{B1}=0.2A, I_{B2}=0.2A$)		t_r			0.75	μs
Storage Time ($V_{CC}=250V, I_C=1.2A, I_{B1}=0.2A, I_{B2}=0.2A$)		t_s			5.0	μs
Fall Time ($V_{CC}=250V, I_C=1.2A, I_{B1}=0.2A, I_{B2}=0.2A$)		t_f			0.75	μs

*Pulse measurement conditions: Length = 300 μs , Duty Cycle $\leq 2\%$.



GENERAL
SEMICONDUCTOR
INDUSTRIES, INC.

C²R
2N6079

NPN SWITCHING POWER TRANSISTORS

This unique device utilizes General Semiconductor Industries' C²R process (patent applied for) which describes a manufacturing technology that provides surface stabilization for high voltage operation and enhances long term reliability.

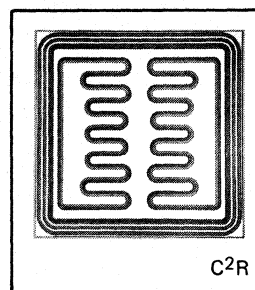
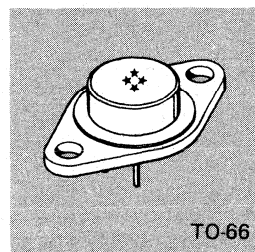

MAXIMUM RATINGS

RATINGS	SYMBOL	2N6079	UNIT
Collector-Base Voltage	V_{CBO}	375	Vdc
Collector-Emitter Voltage	V_{CEX}	375	Vdc
Emitter-Base Voltage	V_{EBO}	9	Vdc
Collector Current - Continuous	I_C	7.0	Adc
Base Current - Continuous	I_B	4.0	Adc
Total Power Dissipation @ $T_C=100^{\circ}C$	P_D	25.7	Watt
Junction Temperature	$T_J(MAX)$	200	$^{\circ}C$
Storage Temperature	T_{stg}	-65 to +200	$^{\circ}C$

4

NPN SWITCHING
TRANSISTORS

ELECTRICAL CHARACTERISTICS (T = 25°C unless otherwise specified)

CHARACTERISTIC	SYMBOL	MIN	TYP	MAX	UNIT
----------------	--------	-----	-----	-----	------

OFF CHARACTERISTICS

Collector-Emitter Voltage ($I_C=0.2A$)	V_{CEO}	350			Vdc
Emitter Cutoff Current ($V_{EB}=9V$)	I_{EBO}			1.0	mA
Collector Cutoff Current ($V_{CE}=450V, V_{BE} = -1.5V, T_C=125^\circ C$)	I_{CEV}			5	mA
Collector Cutoff Current ($V_{CE}=450V, V_{BE} = -1.5V$)	I_{CEV}			0.5	mA

ON CHARACTERISTICS

DC Current Gain ($V_{CE}=1.0V, I_C=1.2A$)	h_{FE}^*	12		50	
Collector Saturation Voltage ($I_C=4A, I_B=0.8A$)	$V_{CE(sat)}^*$			3.0	Vdc
Collector Saturation Voltage ($I_C=1.2A, I_B=0.2A$)	$V_{CE(sat)}^*$			0.5	Vdc
Base Saturation Voltage ($I_C=4A, I_B=0.8A$)	$V_{BE(sat)}^*$			2.0	Vdc
Base Saturation Voltage ($I_C=1.2A, I_B=0.2A$)	$V_{BE(sat)}^*$			1.6	Vdc

DYNAMIC CHARACTERISTICS

Small Signal Current Gain ($V_{CE}=10V, I_C=0.2A, f=1.0MHz$)	$ h_{fe} $	1.0			
Rise Time ($V_{CC}=250V, I_C=1.2A, I_{B1}=0.2A, I_{B2}=0.2A$)	t_r			0.75	μs
Storage Time ($V_{CC}=250V, I_C=1.2A, I_{B1}=0.2A, I_{B2}=0.2A$)	t_s			5.0	μs
Fall Time ($V_{CC}=250V, I_C=1.2A, I_{B1}=0.2A, I_{B2}=0.2A$)	t_f			0.75	μs

*Pulse measurement conditions: Length = 300 μs , Duty Cycle \leq 2%.



**GENERAL
SEMICONDUCTOR
INDUSTRIES, INC.**

2N6232

SILICON NPN TRANSISTORS

These double diffused, epitaxial collector devices are oxide passivated. They are designed for use in switching and many amplifier applications. The latest technologies are used to provide optimum performance and the highest degree of reliability.

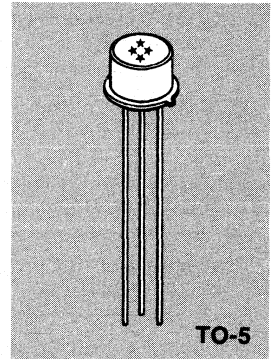

4

**NPN SWITCHING
TRANSISTORS**

ABSOLUTE MAXIMUM RATINGS

RATINGS	SYMBOL	2N6232	UNIT
Collector-Base Voltage	V_{CBO}	140	Vdc
Collector-Emitter Voltage	V_{CEO}	100	Vdc
Emitter-Base Voltage	V_{EBO}	7.0	Vdc
Collector Current — Continuous	I_C	10	Adc
Base Current — Continuous	I_B	2.0	Adc
Total Power Dissipation @ $T_C=100^\circ\text{C}$	P_D	15	Watt
Thermal Resistance (Junction to Case)	θ_{c-c}	6.67	$^\circ\text{C/W}$
Junction Temperature	T_J	-65 to +200	$^\circ\text{C}$
Storage Temperature	T_{stg}	+200	$^\circ\text{C}$

ELECTRICAL CHARACTERISTICS (T = 25°C unless otherwise specified)

CHARACTERISTIC	SYMBOL	MIN	TYP	MAX	UNIT
OFF CHARACTERISTICS					
Collector-Base Voltage ($I_C = 1.0\text{mA}$)	BV_{CBO}	140			Vdc
Collector-Emitter Voltage ($I_C = 100\text{mA}$)	BV_{CEO}	100			Vdc
Emitter-Base Voltage ($I_E = 10\ \mu\text{A}$)	BV_{EBO}	7.0			Vdc
Collector-Emitter Breakdown Voltage ($I_C = 10\text{mA}$, $R_{BE} = 10\Omega$)	BV_{CER}	140			Vdc
Collector Cutoff Current ($V_{CB} = 140\text{V}$)	I_{CBO}			0.2	μA
Collector Cutoff Current ($V_{CE} = 140\text{V}$)	I_{CES}			0.2	μA
ON CHARACTERISTICS					
DC Current Gain ($V_{CE} = 2.0\text{V}$, $I_C = 0.5\text{A}$)	h_{FE}^*	40		250	
DC Current Gain ($V_{CE} = 2.0\text{V}$, $I_C = 5.0\text{A}$)	h_{FE}^*	25		100	
DC Current Gain ($V_{CE} = 5.0\text{V}$, $I_C = 10\text{A}$)	h_{FE}^*	20			
Collector Saturation Voltage ($I_C = 5.0\text{A}$, $I_B = 0.5\text{A}$)	$V_{CE(\text{sat})}^*$			0.7	Vdc
Collector Saturation Voltage ($I_C = 10\text{A}$, $I_B = 1.0\text{A}$)	$V_{CE(\text{sat})}^*$			1.4	Vdc
Base Saturation Voltage ($I_C = 5.0\text{A}$, $I_B = 0.5\text{A}$)	$V_{BE(\text{sat})}^*$			1.4	Vdc
Base Saturation Voltage ($I_C = 10\text{A}$, $I_B = 1.0\text{A}$)	$V_{BE(\text{sat})}^*$			1.8	Vdc
DYNAMIC CHARACTERISTICS					
Small Signal Current Gain ($V_{CE} = 10\text{V}$, $I_C = 0.2\text{A}$, $f = 10\text{MHz}$)	$ h_{fe} $	3.0			
Collector Base Capacitance ($V_{CB} = 10\text{V}$, $I_C = \quad$, $f = 1.0\text{MHz}$)	C_{ob}			150	pF
Turn-on Time ($V_{CC} = 30\text{V}$, $I_C = 5.0\text{A}$, $I_{B1} = 0.5\text{A}$, $I_{B2} = 0.5\text{A}$)	t_{on}			0.25	μs
Turn-off Time ($V_{CC} = 30\text{V}$, $I_C = 5.0\text{A}$, $I_{B1} = 0.5\text{A}$, $I_{B2} = 0.5\text{A}$)	t_{off}			1.2	μs



**GENERAL
SEMICONDUCTOR
INDUSTRIES, INC.**

C²R
2N6233
2N6234
2N6235

NPN SWITCHING POWER TRANSISTORS

This unique series utilizes General Semiconductor Industries' C²R process (patent applied for) which describes a manufacturing technology that provides surface stabilization for high voltage operation and enhances long term reliability.

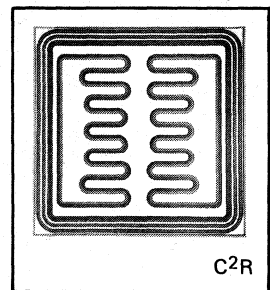
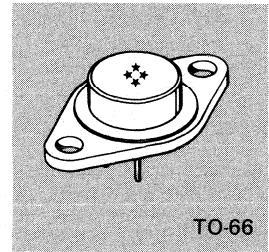

MAXIMUM RATINGS

RATINGS	SYMBOL	2N6233	2N6234	2N6235	UNIT
Collector-Base Voltage	V_{CBO}	250	300	350	Vdc
Collector-Emitter Voltage	V_{CEO}	225	275	325	Vdc
Emitter-Base Voltage	V_{EBO}	6.0			Vdc
Collector Current - Continuous	I_C	5.0			Adc
Base Current - Continuous	I_B	2.0			Adc
Total Power Dissipation@ $T_C=25^\circ\text{C}$	P_D	50			Watt
Thermal Resistance (Junction to Case)	θ_{J-C}	3.5			$^\circ\text{C}/\text{W}$
Junction Temperature	T_J	-65 to +200			$^\circ\text{C}$
Storage Temperature	T_{stg}	-65 to +200			$^\circ\text{C}$

4

NPN SWITCHING
TRANSISTORS

ELECTRICAL CHARACTERISTICS (T = 25°C unless otherwise specified)

CHARACTERISTIC	SYMBOL	MIN	TYP	MAX	UNIT
----------------	--------	-----	-----	-----	------

OFF CHARACTERISTICS

Collector-Base Voltage ($I_C=100\mu A$)	2N6233 2N6234 2N6235	BV_{CBO}	250 300 350			Vdc
Collector-Emitter Voltage ($I_C=20mA$)	2N6233 2N6234 2N6235	BV_{CEO}	225 275 325			Vdc
Emitter-Base Voltage ($I_E=100\mu A$)		BV_{EBO}	6.0			Vdc
Collector Cutoff Current ($V_{CB}=\text{Rated } V_{CB}$)		I_{CBO}			100	μA
Emitter Cutoff Current ($V_{EB}=6.0V$)		I_{EBO}			100	μA

ON CHARACTERISTICS

DC Current Gain ($V_{CE}=5.0V, I_C=100mA$)		h_{FE}^*	25			
DC Current Gain ($V_{CE}=5.0V, I_C=1.0A$)		h_{FE}^*	25		125	
Collector Saturation Voltage ($I_C=1.0A, I_B=100mA$)		$V_{CE}(\text{sat})^*$			0.5	Vdc
Base Saturation Voltage ($I_C=1.0A, I_B=100mA$)		$V_{BE}(\text{sat})^*$			1.0	Vdc

DYNAMIC CHARACTERISTICS

Small Signal Current Gain ($V_{CE}=10V, I_C=0.25A, f=10MHz$)		$ h_{fe} $	2.0			
Collector Base Capacitance ($V_{CB}=10V, f=1MHz$)		C_{ob}			250	pF
Delay Time ($V_{CC}=200V, I_C=1.0A, I_{B1}=100mA, I_{B2}=100mA$)		t_d			0.05	μs
Rise Time ($V_{CC}=200V, I_C=1.0A, I_{B1}=100mA, I_{B2}=100mA$)		t_r			0.5	μs
Storage Time ($V_{CC}=200V, I_C=1.0A, I_{B1}=100mA, I_{B2}=100mA$)		t_s			3.5	μs
Fall Time ($V_{CC}=200V, I_C=1.0A, I_{B1}=100mA, I_{B2}=100mA$)		t_f			0.5	μs

*Pulse measurement conditions: Length = 300 μs , Duty Cycle \leq 2%.



GENERAL
SEMICONDUCTOR
INDUSTRIES, INC.

NPN
2N6274

SILICON NPN TRANSISTORS

These double diffused, epitaxial collector devices are oxide passivated. They are designed for use in switching and many amplifier applications. The latest technologies are used to provide optimum performance and the highest degree of reliability.

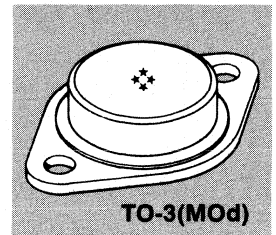

ABSOLUTE MAXIMUM RATINGS

RATINGS	SYMBOL	2N6274	UNIT
Collector-Base Voltage	V_{CBO}	120	Vdc
Collector-Emitter Voltage	V_{CEO}	100	Vdc
Emitter-Base Voltage	V_{EBO}	6.0	Vdc
Collector Current — Continuous	I_C	50	Adc
Base Current — Continuous	I_B	20	Adc
Total Power Dissipation @ $T_C=25^\circ\text{C}$	P_D	250	Watt
Thermal Resistance (Junction to Case)	Θ_{c}	0.7	$^\circ\text{C}/\text{W}$
Junction Temperature	T_J	-65 to +200	$^\circ\text{C}$
Storage Temperature	T_{stg}	-65 to +200	$^\circ\text{C}$

ELECTRICAL CHARACTERISTICS (T = 25°C unless otherwise specified)

CHARACTERISTIC	SYMBOL	MIN	TYP	MAX	UNIT
OFF CHARACTERISTICS					
Collector-Emitter Sustaining Voltage ($I_C=50\text{mA}$)	$BV_{CEO(sus)}$	100			Vdc
Emitter Cutoff Current ($V_{EB}=6.0\text{V}$)	I_{EBO}			100	μA
Collector Cutoff Current ($V_{CE}=\text{Rated } V_{CB}$) $V_{EB}=1.5\text{V}$)	I_{CEX}			10	μA
Collector Cutoff Current ($V_{CE}=\text{Rated } V_{CB}$) $V_{EB}=1.5\text{V}$) @ $T_C=150^\circ\text{C}$	I_{CEX}			1.0	mA
ON CHARACTERISTICS					
DC Current Gain ($V_{CE}=4.0\text{V}$, $I_C=1.0\text{A}$)	h_{FE}^*	50			
DC Current Gain ($V_{CE}=4.0\text{V}$, $I_C=20\text{A}$)	h_{FE}^*	30		120	
DC Current Gain ($V_{CE}=4.0\text{V}$, $I_C=50\text{A}$)	h_{FE}^*	10			
Collector Saturation Voltage ($I_C=20\text{A}$, $I_B=2.0\text{A}$)	$V_{CE(sat)}^*$			1.0	Vdc
Collector Saturation Voltage ($I_C=50\text{A}$, $I_B=10\text{A}$)	$V_{CE(sat)}^*$			3.0	Vdc
Base Saturation Voltage ($I_C=20\text{A}$, $I_B=2.0\text{A}$)	$V_{BE(sat)}^*$			1.8	Vdc
Base Saturation Voltage ($I_C=50\text{A}$, $I_B=10\text{A}$)	$V_{BE(sat)}^*$			3.5	Vdc
DYNAMIC CHARACTERISTICS					
Small Signal Current Gain ($V_{CE}=10\text{V}$, $I_C=1.0\text{A}$, $f=10\text{MHz}$)	$ h_{fe} $	3.0			
Collector Base Capacitance ($V_{CB}=10\text{V}$, $f=0.1\text{MHz}$)	C_{ob}			600	pF
Rise Time ($V_{CC}=80\text{V}$, $I_C=20\text{A}$, $I_{B1}=2.0\text{A}$, $I_{B2}=2.0\text{A}$)				0.35	μs
Storage Time ($V_{CC}=80\text{V}$, $I_C=20\text{A}$, $I_{B1}=2.0\text{A}$, $I_{B2}=2.0\text{A}$)	t_s			0.80	μs
Fall Time ($V_{CC}=80\text{V}$, $I_C=20\text{A}$, $I_{B1}=2.0\text{A}$, $I_{B2}=2.0\text{A}$)	t_f			0.25	μs

*Pulse Measurement Conditions: Length = 300 μs , Duty Cycle \leq 2%



**GENERAL
SEMICONDUCTOR
INDUSTRIES, INC.**

C²R

**2N6275
2N6276**

NPN SWITCHING POWER TRANSISTORS

This unique series utilizes General Semiconductor Industries' C²R process (patent applied for) which describes a manufacturing technology that provides surface stabilization for high voltage operation and enhances long term reliability.

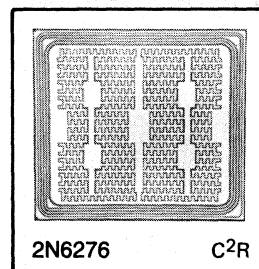
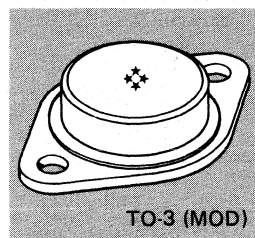

MAXIMUM RATINGS

RATINGS	SYMBOL	2N6275	2N6276	UNIT
Collector-Base Voltage	V_{CBO}	140	160	Vdc
Emitter-Base Voltage	V_{EBO}	6		Vdc
Collector Current - Continuous	I_C	50		Adc
Base Current - Continuous	I_B	20		Adc
Total Power Dissipation @ $T_C=25^\circ\text{C}$	P_D	250		Watt
Junction Temperature	T_J	-65 to +200		$^\circ\text{C}$
Storage Temperature	T_{stg}	-65 to +200		$^\circ\text{C}$

4

**NPN SWITCHING
TRANSISTORS**

ELECTRICAL CHARACTERISTICS (T = 25°C unless otherwise specified)

CHARACTERISTIC	SYMBOL	MIN	TYP	MAX	UNIT
----------------	--------	-----	-----	-----	------

OFF CHARACTERISTICS

Collector-Emitter Sustaining Voltage ($I_C=50mA$)	2N6275 2N6276	BV_{CEO} (sus)	120 140		Vdc
Emitter Cutoff Current ($V_{EB}=6V$)		I_{EBO}		100	μA
Collector Cutoff Current ($V_{CE}=140V, V_{BE}=1.5V, T_C=150^\circ C$) ($V_{CE}=160V, V_{BE}=1.5V, T_C=150^\circ C$)	2N6275 2N6276	I_{CEX}		1.0 1.0	mA
Collector Cutoff Current ($V_{CE}=140V, V_{BE}=1.5V$) ($V_{CE}=160V, V_{BE}=1.5V$)	2N6275 2N6276	I_{CEX}		1.0	μA

ON CHARACTERISTICS

DC Current Gain ($V_{CE}=4V, I_C=50A$)		h_{FE}^*	10		
DC Current Gain ($V_{CE}=4V, I_C=20A$)		h_{FE}^*	30	120	
DC Current Gain ($V_{CE}=4V, I_C=1A$)		h_{FE}^*	50		
Base Emitter On Voltage ($V_{CE}=4V, I_C=20A$)		V_{BE} (on)		1.8	V
Collector Saturation Voltage ($I_C=50A, I_B=10A$)		V_{CE} (sat)*		3.0	Vdc
Collector Saturation Voltage ($I_C=20A, I_B=2A$)		V_{CE} (sat)*		1.0	Vdc
Base Saturation Voltage ($I_C=50A, I_B=10A$)		V_{BE} (sat)*		3.5	Vdc
Base Saturation Voltage ($I_C=20A, I_B=2A$)		V_{BE} (sat)*		1.8	Vdc

DYNAMIC CHARACTERISTICS

Small Signal Current Gain ($V_{CE}=10V, I_C=1A, f=10MHz$)		$ h_{fe} $	3		
Collector Base Capacitance ($V_{CB}=10V, f=0.1MHz$)		C_{ob}		600	pF
Rise Time ($V_{CC}=80V, I_C=20A, I_{B1}=2A, I_{B2}=2A$)		t_r		0.35	μs
Storage Time ($V_{CC}=80V, I_C=20A, I_{B1}=2A, I_{B2}=2A$)		t_s		0.80	μs
Fall Time ($V_{CC}=80V, I_C=20A, I_{B1}=2A, I_{B2}=2A$)		t_f		0.25	μs

*Pulse measurement conditions: Length = 300 μs , Duty Cycle \leq 2%.



**GENERAL
SEMICONDUCTOR
INDUSTRIES, INC.**

C²R

2N6277

NPN SWITCHING POWER TRANSISTORS

This unique device utilizes General Semiconductor Industries' C²R process (patent applied for) which describes a manufacturing technology that provides surface stabilization for high voltage operation and enhances long term reliability.

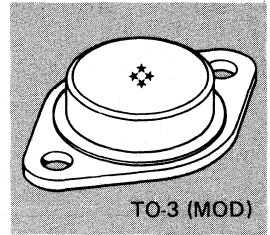

TO-3 (MOD)

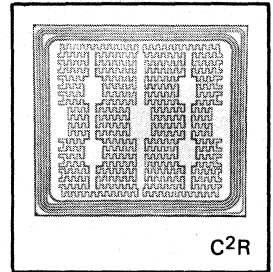

C²R

MAXIMUM RATINGS

RATINGS	SYMBOL	2N6277	UNIT
Collector-Base Voltage	V_{CBO}	180	Vdc
Collector-Emitter Voltage	V_{CEO}	150	Vdc
Emitter-Base Voltage	V_{EBO}	6	Vdc
Collector Current - Continuous	I_C	50	Adc
Base Current - Continuous	I_B	20	Adc
Total Power Dissipation @ $T_C=25^\circ\text{C}$	P_D	250	Watt
Thermal Resistance (Junction to Case)	θ_{JC}	0.7	$^\circ\text{C}/\text{W}$
Junction Temperature	T_J	-65 to +200	$^\circ\text{C}$
Storage Temperature	T_{stg}	-65 to +200	$^\circ\text{C}$

4

NPN SWITCHING
TRANSISTORS

ELECTRICAL CHARACTERISTICS (T = 25°C unless otherwise specified)

CHARACTERISTIC	SYMBOL	MIN	TYP	MAX	UNIT
----------------	--------	-----	-----	-----	------

OFF CHARACTERISTICS

Collector-Emitter Sustaining Voltage ($I_C=50\text{mA}$)	BV_{CEO} (sus)	150			Vdc
Emitter Cutoff Current ($V_{EB}=6\text{V}$)	I_{EBO}			100	μA
Collector Cutoff Current ($V_{CE}=180\text{V}$, $V_{BE}=1.5\text{V}$, $T_C=150^\circ\text{C}$)	I_{CEX}			1.0	mA
Collector Cutoff Current ($V_{CE}=180\text{V}$, $V_{BE}=1.5\text{V}$)	I_{CEX}			10	μA

ON CHARACTERISTICS

DC Current Gain ($V_{CE}=4\text{V}$, $I_C=50\text{A}$)	h_{FE}^*	10			
DC Current Gain ($V_{CE}=4\text{V}$, $I_C=20\text{A}$)	h_{FE}^*	30		120	
DC Current Gain ($V_{CE}=4\text{V}$, $I_C=1\text{A}$)	h_{FE}^*	50			
Base Emitter On Voltage ($V_{CE}=4\text{V}$, $I_C=20\text{A}$)	V_{BE} (on)			1.8	V
Collector Saturation Voltage ($I_C=50\text{A}$, $I_B=10\text{A}$)	$V_{CE}(\text{sat})^*$			3.0	Vdc
Collector Saturation Voltage ($I_C=20\text{A}$, $I_B=2\text{A}$)	$V_{CE}(\text{sat})^*$			1.0	Vdc
Base Saturation Voltage ($I_C=50\text{A}$, $I_B=10\text{A}$)	$V_{BE}(\text{sat})^*$			3.5	Vdc
Base Saturation Voltage ($I_C=20\text{A}$, $I_B=2\text{A}$)	$V_{BE}(\text{sat})^*$			1.8	Vdc

DYNAMIC CHARACTERISTICS

Small Signal Current Gain ($V_{CE}=10\text{V}$, $I_C=1\text{A}$, $f=10\text{MHz}$)	$ h_{fe} $	3			
Collector Base Capacitance ($V_{CB}=10\text{V}$, $I_C=0$, $f=0.1\text{MHz}$)	C_{ob}			600	pF
Rise Time ($V_{CC}=80\text{V}$, $I_C=20\text{A}$, $I_{B1}=2\text{A}$, $I_{B2}=2\text{A}$)	t_r			0.35	μs
Storage Time ($V_{CC}=80\text{V}$, $I_C=20\text{A}$, $I_{B1}=2\text{A}$, $I_{B2}=2\text{A}$)	t_s			0.80	μs
Fall Time ($V_{CC}=80\text{V}$, $I_C=20\text{A}$, $I_{B1}=2\text{A}$, $I_{B2}=2\text{A}$)	t_f			0.25	μs

*Pulse measurement conditions: Length = 300 μs , Duty Cycle \leq 2%.



GENERAL
SEMICONDUCTOR
INDUSTRIES, INC.

2N6278

SILICON NPN TRANSISTORS

These double diffused, epitaxial collector devices are oxide passivated. They are designed for use in switching and many amplifier applications. The latest technologies are used to provide optimum performance and the highest degree of reliability.

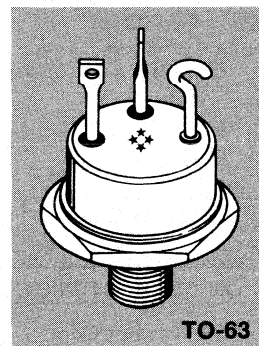

4

NPN SWITCHING
TRANSISTORS

ABSOLUTE MAXIMUM RATINGS

RATINGS	SYMBOL	2N6278	UNIT
Collector-Base Voltage	V_{CBO}	120	Vdc
Collector-Emitter Voltage	V_{CEO}	100	Vdc
Emitter-Base Voltage	V_{EBO}	6.0	Vdc
Collector Current — Continuous	I_C	50	Adc
Base Current — Continuous	I_B	20	Adc
Total Power Dissipation @ $T_C = 25^\circ\text{C}$	P_D	250	Watt
Thermal Resistance (Junction to Case)	Θ_{-C}	0.7	$^\circ\text{C}/\text{W}$
Junction Temperature	T_J	-65 to +200	$^\circ\text{C}$
Storage Temperature	T_{stg}	-65 to +200	$^\circ\text{C}$

ELECTRICAL CHARACTERISTICS (T = 25°C unless otherwise specified)

CHARACTERISTIC	SYMBOL	MIN	TYP	MAX	UNIT
OFF CHARACTERISTICS					
Collector-Emitter Sustaining Voltage ($I_C = 50\text{mA}$)	$BV_{CEO(SUS)}$	100			Vdc
Emitter-Base Voltage ($I_E = 100\ \mu\text{A}$)	BV_{EBO}	6.0			Vdc
Emitter Cutoff Current ($V_{EB} = 6.0\text{V}$)	I_{EBO}			100	μA
Collector Cutoff Current ($V_{CE} = \text{Rated } V_{CB}, V_{EB} = 1.5\text{V}$)	I_{CEX}			10	μA
Collector Cutoff Current ($V_{CE} = \text{Rated } V_{CB}, V_{EB} = 1.5\text{V @ } T_C = 150^\circ\text{C}$)	I_{CEX}			1.0	mA
ON CHARACTERISTICS					
DC Current Gain ($V_{CE} = 4.0\text{V}, I_C = 1.0\text{A}$)	h_{FE}^*	50			
DC Current Gain ($V_{CE} = 4.0\text{V}, I_C = 20\text{A}$)	h_{FE}^*	30		120	
DC Current Gain ($V_{CE} = 4.0\text{V}, I_C = 50\text{A}$)	h_{FE}^*	10			
Collector Saturation Voltage ($I_C = 20\text{A}, I_B = 2.0\text{A}$)	$V_{CE(sat)}^*$			1.2	Vdc
Collector Saturation Voltage ($I_C = 50\text{A}, I_B = 10\text{A}$)	$V_{CE(sat)}^*$			3.0	Vdc
Case Saturation Voltage ($I_C = 20\text{A}, I_B = 2.0\text{A}$)	$V_{BE(sat)}^*$			1.8	Vdc
Base Saturation Voltage ($I_C = 50\text{A}, I_B = 10\text{A}$)	$V_{BE(sat)}^*$			3.5	Vdc
DYNAMIC CHARACTERISTICS					
Small Signal Current Gain ($V_{CE} = 10\text{V}, I_C = 1.0\text{A}, f = 10\text{MHz}$)	$ h_{fe} $	3.0			
Collector Base Capacitance ($V_{CB} = 10\text{V}, f = 0.1\text{MHz}$)	C_{ob}			600	pF
Rise Time ($V_{CC} = 80\text{V}, I_C = 20\text{A}, I_{B1} = 2.0\text{A}, I_{B2} = 2.0\text{A}$)	t_r			0.35	μs
Storage Time ($V_{CC} = 80\text{V}, I_C = 20\text{A}, I_{B1} = 2.0\text{A}, I_{B2} = 2.0\text{A}$)	t_s			0.80	μs
Fall Time ($V_{CC} = 80\text{V}, I_C = 20\text{A}, I_{B1} = 2.0\text{A}, I_{B2} = 2.0\text{A}$)	t_f			0.25	μs

*Pulse Measurement Conditions: Length = 300 μs , Duty Cycle \leq 2%



GENERAL
SEMICONDUCTOR
INDUSTRIES, INC.

C²R

2N6279
2N6280
2N6281

NPN SWITCHING POWER TRANSISTORS

This unique series utilizes General Semiconductor Industries' C²R process (patent applied for) which describes a manufacturing technology that provides surface stabilization for high voltage operation and enhances long term reliability.

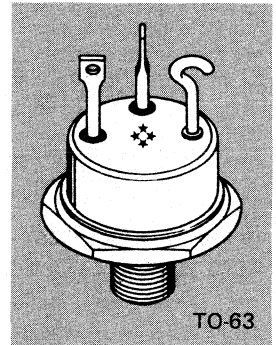

TO-63

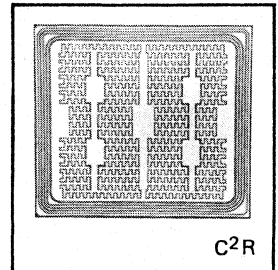

C²R

MAXIMUM RATINGS

RATINGS	SYMBOL	2N6279	2N6280	2N6281	UNIT
Collector-Base Voltage	V_{CBO}	140	160	180	Vdc
Collector-Emitter Voltage	V_{CEO}	120	140	150	Vdc
Emitter-Base Voltage	V_{EBO}		6.0		Vdc
Collector Current - Continuous	I_C		50		Adc
Base Current - Continuous	I_B		20		Adc
Total Power Dissipation @ $T_C=25^\circ\text{C}$	P_D		250		Watt
Thermal Resistance (Junction to Case)	θ_{J-C}		0.7		$^\circ\text{C}/\text{W}$
Junction Temperature	T_J		-65 to +200		$^\circ\text{C}$
Storage Temperature	T_{stg}		-65 to +200		$^\circ\text{C}$

4

NPN SWITCHING
TRANSISTORS

ELECTRICAL CHARACTERISTICS (T = 25°C unless otherwise specified)

CHARACTERISTIC	SYMBOL	MIN	TYP	MAX	UNIT
----------------	--------	-----	-----	-----	------

OFF CHARACTERISTICS

Collector-Emitter Voltage ($I_C=50mA$)	2N6279 2N6280 2N6281	V_{CEO}	120 140 150		Vdc
Emitter Cutoff Current ($V_{EB}=6.0V$)		I_{EBO}		100	μA
Collector Cutoff Current ($V_{CE}=\text{Rated } V_{CB}, V_{EB}=1.5V$)	2N6279 2N6280 2N6281	I_{CEX}		10 10 10	μA
Collector Cutoff Current ($V_{CE}=\text{Rated } V_{CB}, V_{EB}=1.5V, T_C=150^\circ C$)	2N6279 2N6280 2N6281	I_{CEX}		1.0 1.0 1.0	mA

ON CHARACTERISTICS

DC Current Gain ($V_{CE}=4.0V, I_C=1.0A$)		h_{FE}^*	50		
DC Current Gain ($V_{CE}=4.0V, I_C=20A$)		h_{FE}^*	30	120	
Collector Saturation Voltage ($I_C=20A, I_B=2.0A$)		$V_{CE}(\text{sat})^*$		1.2	Vdc
Collector Saturation Voltage ($I_C=50A, I_B=10A$)		$V_{CE}(\text{sat})^*$		3.0	Vdc
Base Saturation Voltage ($I_C=20A, I_B=2.0$)		$V_{BE}(\text{sat})^*$		1.8	Vdc
Base Saturation Voltage ($I_C=50A, I_B=10A$)		$V_{BE}(\text{sat})^*$		3.5	Vdc

DYNAMIC CHARACTERISTICS

Small Signal Current Gain ($V_{CE}=10V, I_C=1.0A, f=10MHz$)		$ h_{fe} $	3.0		
Collector Base Capacitance ($V_{CB}=10V, I_E=0, f=0.1MHz$)		C_{ob}		600	pF
Rise Time ($V_{CC}=80V, I_C=20A, I_{B1}=2.0A, I_{B2}=2.0A$)		t_r		0.35	μs
Storage Time ($V_{CC}=80V, I_C=20A, I_{B1}=2.0A, I_{B2}=2.0A$)		t_s		0.80	μs
Fall Time ($V_{CC}=80V, I_C=20A, I_{B1}=2.0A, I_{B2}=2.0A$)		t_f		0.25	μs

*Pulse measurement conditions: Length = 300 μs , Duty Cycle \leq 2%.



GENERAL
SEMICONDUCTOR
INDUSTRIES, INC.

NPN
2N6338
2N6339

SILICON NPN TRANSISTORS

These double diffused, epitaxial collector devices are oxide passivated. They are designed for use in switching and many amplifier applications. The latest technologies are used to provide optimum performance and the highest degree of reliability.

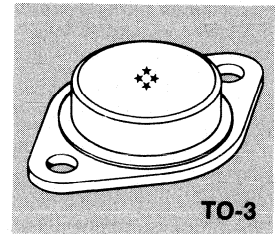

4

NPN SWITCHING
TRANSISTORS

ABSOLUTE MAXIMUM RATINGS

RATINGS	SYMBOL	2N6338	2N6339	UNIT
Collector-Base Voltage	V_{CBO}	120	140	Vdc
Collector-Emitter Voltage	V_{CEO}	100	120	Vdc
Emitter-Base Voltage	V_{EBO}	6.0	6.0	Vdc
Collector Current — Continuous	I_C	25	25	Adc
Base Current — Continuous	I_B	10	10	Adc
Total Power Dissipation @ $T_C = 25^\circ\text{C}$	P_D	200	200	Watt
Thermal Resistance (Junction to Case)	θ_{c-c}	.875	.875	$^\circ\text{C}/\text{W}$
Junction Temperature	T_J	-65 to +200	-65 to +200	$^\circ\text{C}$
Storage Temperature	T_{stg}	-65 to +200	-65 to +200	$^\circ\text{C}$

ELECTRICAL CHARACTERISTICS (T = 25°C unless otherwise specified)

CHARACTERISTIC	SYMBOL	MIN	TYP	MAX	UNIT
OFF CHARACTERISTICS					
Collector-Emitter Sustaining Voltage ($I_C = 50 \text{ MA}$)	2N6338 2N6339 $BV_{CEO(SUS)}$	100 120			Vdc
Collector-Emitter Cutoff Current ($V_{CE} = \text{Rated } V_{CEO}$)	I_{CEX}			10	μA
Emitter Cutoff Current ($V_{EB} = 6.0\text{V}$)	I_{EBO}			100	μA
Collector Cutoff Current ($V_{CB} = \text{Rated } V_{CBO}$)	I_{CBO}			10	μA
ON CHARACTERISTICS					
DC Current Gain ($V_{CE} = 2.0\text{V}, I_C = 0.5\text{A}$)	h_{FE}^*	50			
DC Current Gain ($V_{CE} = 2.0\text{V}, I_C = 10\text{A}$)	h_{FE}^*	30		120	
DC Current Gain ($V_{CE} = 2.0\text{V}, I_C = 25\text{A}$)	h_{FE}^*	12			
Collector Saturation Voltage ($I_C = 10\text{A}, I_B = 1.0\text{A}$)	$V_{CE(sat)}^*$			1.0	Vdc
Collector Saturation Voltage ($I_C = 25\text{A}, I_B = 2.5\text{A}$)	$V_{CE(sat)}^*$			1.8	Vdc
Base Saturation Voltage ($I_C = 10\text{A}, I_B = 1.0\text{A}$)	$V_{BE(sat)}^*$			1.8	Vdc
Base Saturation Voltage ($I_C = 25\text{A}, I_B = 2.5\text{A}$)	$V_{BE(sat)}^*$			2.5	Vdc
DYNAMIC CHARACTERISTICS					
Small Signal Current Gain ($V_{CE} = 10\text{V}, I_C = 1.0\text{A}, f = 10\text{MHz}$)	$ h_{fe} $	4.0			
Collector Base Capacitance ($V_{CB} = 10\text{V}, I_C = \text{ , } f = 0.1\text{MHz}$)	C_{ob}			300	pF
Rise Time ($V_{CC} = 80\text{V}, I_C = 10\text{A}, I_{B1} = 1.0\text{A}, I_{B2} = 1.0\text{A}$)	t_r			0.3	μs
Storage Time ($V_{CC} = 80\text{V}, I_C = 10\text{A}, I_{B1} = 1.0\text{A}, I_{B2} = 1.0\text{A}$)	t_s			1.0	μs
Fall Time ($V_{CC} = 80\text{V}, I_C = 10\text{A}, I_{B1} = 1.0\text{A}, I_{B2} = 1.0\text{A}$)	t_f			0.25	μs

*Pulse Measurement Conditions: Length = 300 μs , Duty Cycle \leq 2%



GENERAL
SEMICONDUCTOR
INDUSTRIES, INC.

NPN
2N6340
2N6341

SILICON NPN TRANSISTORS

These double diffused, epitaxial collector devices are oxide passivated. They are designed for use in switching and many amplifier applications. The latest technologies are used to provide optimum performance and the highest degree of reliability.

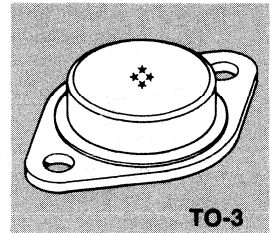

4

NPN SWITCHING
TRANSISTORS

ABSOLUTE MAXIMUM RATINGS

RATINGS	SYMBOL	2N6340	2N6341	UNIT
Collector-Base Voltage	V_{CBO}	160	180	Vdc
Collector-Emitter Voltage	V_{CEO}	140	150	Vdc
Emitter-Base Voltage	V_{EBO}	6.0	6.0	Vdc
Collector Current — Continuous	I_C	25	25	Adc
Base Current — Continuous	I_B	10	10	Adc
Total Power Dissipation @ $T_C = 25^\circ\text{C}$	P_D	200	200	Watt
Thermal Resistance (Junction to Case)	θ_{J-C}	.875	.875	$^\circ\text{C}/\text{W}$
Junction Temperature	T_J	-65 to +200		$^\circ\text{C}$
Storage Temperature	T_{stg}	-65 to +200		$^\circ\text{C}$

ELECTRICAL CHARACTERISTICS (T = 25°C unless otherwise specified)

CHARACTERISTIC	SYMBOL	MIN	TYP	MAX	UNIT
OFF CHARACTERISTICS					
Collector-Emitting Sustaining Voltage ($I_C = 50\text{ ma}$)	2N6340 2N6341 $BV_{CEO(SUS)}$	140 150			Vdc
Collector Cutoff Current ($V_{CE} = \text{Rated } V_{CB}$)	I_{CEX}	10			μA
Emitter Cutoff Current ($V_{EB} = 6.0\text{V}$)	I_{EBO}			100	μA
Collector Cutoff Current ($V_{CB} = \text{Rated } V_{CE}$)	I_{CBO}			10	μA
ON CHARACTERISTICS					
DC Current Gain ($V_{CE} = 2.0\text{V}$, $I_C = 0.5\text{A}$)	h_{FE}^*	50			
DC Current Gain ($V_{CE} = 2.0\text{V}$, $I_C = 10\text{A}$)	h_{FE}^*	30		120	
DC Current Gain ($V_{CE} = 2.0\text{V}$, $I_C = 25\text{A}$)	h_{FE}^*	12			
Collector Saturation Voltage ($I_C = 10\text{A}$, $I_B = 1.0\text{A}$)	$V_{CE(sat)}^*$			1.0	Vdc
Collector Saturation Voltage ($I_C = 25\text{A}$, $I_B = 2.5\text{A}$)	$V_{CE(sat)}^*$			1.8	Vdc
Base Saturation Voltage ($I_C = 10\text{A}$, $I_B = 1.0\text{A}$)	$V_{BE(sat)}^*$			1.8	Vdc
Base Saturation Voltage ($I_C = 25\text{A}$, $I_B = 2.5\text{A}$)	$V_{BE(sat)}^*$			2.5	Vdc
DYNAMIC CHARACTERISTICS					
Small Signal Current Gain ($V_{CE} = 10\text{V}$, $I_C = 1.0\text{A}$, $f = 10\text{MHz}$)	$ h_{fe} $	4.0			
Collector Base Capacitance ($V_{CB} = 10\text{V}$, $I_C = \text{ , } f = 0.1\text{ MHz}$)	C_{ob}			300	pF
Rise Time ($V_{CC} = 80\text{V}$, $I_C = 10\text{A}$, $I_{B1} = 1.0\text{A}$, $I_{B2} = 1.0\text{A}$)	t_r			0.3	μs
Storage Time ($V_{CC} = 80\text{V}$, $I_C = 10\text{A}$, $I_{B1} = 1.0\text{A}$, $I_{B2} = 1.0\text{A}$)	t_s			1.0	μs
Fall Time ($V_{CC} = 80\text{V}$, $I_C = 10\text{A}$, $I_{B1} = 1.0\text{A}$, $I_{B2} = 1.0\text{A}$)	t_f			0.25	μs

*Pulse Measurement Conditions: Length = 300 μs , Duty Cycle $\leq 2\%$



**GENERAL
SEMICONDUCTOR
INDUSTRIES, INC.**

15 Amp NPN
300, 350, 400V
2N6653, 54, 55
XGSR15030, 35, 40

C²R HIGH SPEED/HIGH POWER SWITCHING TRANSISTORS

The XGSR series is an NPN double diffused epitaxial transistor designed for high speed switching systems. This unique series utilizes General Semiconductor Industries' C²R process (patent applied for) which describes a manufacturing technology that provides surface stabilization for high voltage operation and enhances long term reliability. Another design feature is the use of an interdigitated emitter providing a periphery greater than 7.0 inches (18 cm) which improves both the gain characteristics and current handling capability.

These transistors have been specifically designed and engineered for high speed/high voltage switching applications where the designer is concerned with optimizing power conversion efficiency.

In order to supply the user with a more complete definition of the C²R switching transistor capability, General Semiconductor Industries has attempted to furnish a data sheet with a thorough and meaningful technical dialogue.

FEATURES:

- HIGH VOLTAGE
- HIGH GAIN
- HIGH CURRENT
- LOW SATURATION VOLTAGES
- FAST SWITCHING
- LOW LEAKAGE CURRENT

APPLICATIONS:

- HIGH SPEED SWITCHING
- POWER CONVERSION
- CONVERTERS
- INVERTERS
- CLASS D AMPLIFIERS
- CLASS C AMPLIFIERS

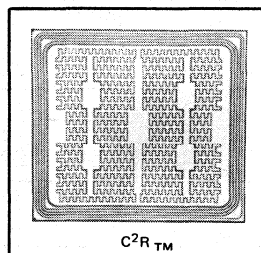
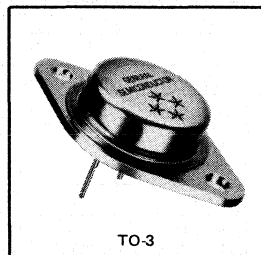

4

NPN SWITCHING
TRANSISTORS

MAXIMUM RATINGS (T _J = 25°C unless otherwise noted)		2N6653 XGSR15030	2N6654 XGSR15035	2N6655 XGSR15040	UNIT
RATING	SYMBOL				
Collector-Base Voltage	V _{CBO}	350	400	450	Volts
Collector-Emitter Voltage	V _{CEO}	300	350	400	Volts
Emitter-Base Voltage	V _{EBO}	7.0	7.0	7.0	Volts
Collector Current - Continuous	I _C	20	20	20	Amps
Peak	I _{CM}	30	30	30	Amps
Base Current-Continuous	I _B	10	10	10	Amps
Emitter Current - Continuous	I _E	30	30	30	Amps
Peak	I _{EM}	40	40	40	Amps
Total Power Dissipation @T _C = 100°C	P _D	75	75	75	Watts
Total Power Dissipation @T _C = 25°C	P _D	150	150	150	Watts
Junction to Case Thermal Resistance	R _{θJC}	1.0	1.0	1.0	°C/W
Operating and Storage Junction Temperature Range	T _{J (oper)} T _{stg}	-65 to +175 -65 to +200	-65 to +175 -65 to +200	-65 to +175 -65 to +200	°C °C



GENERAL SEMICONDUCTOR INDUSTRIES, INC.

2001 West Tenth Place, Tempe, Arizona 85281 • 602-968-3101 • TWX910-950-1942
Mailing Address: P.O. Box 3078

Registered Trademark of General Semiconductor Industries, Inc. Patent Pending.

GENERAL SEMICONDUCTOR INDUSTRIES, INC.

ELECTRICAL CHARACTERISTICS ($T_J = 25^\circ\text{C}$ unless otherwise noted)

SYMBOL	CONDITIONS	2N6653 XGSR15030		2N6654 XGSR15035		2N6655 XGSR15040		UNIT
		Min	Max	Min	Max	Min	Max	
V_{CBO}	$I_C = 1.0\text{mA}$	350	—	400	—	450	—	Volts
V_{CEO}	$I_C = 50\text{mA}$	300	—	350	—	400	—	Volts
V_{EBO}	$I_E = 1.0\text{mA}$	7.0	—	7.0	—	7.0	—	Volts
V_{CEX} (SUS)	$I_C = 50\text{mA}, V_{BE} = -1.5\text{V}$	350	—	400	—	450	—	Volts
V_{CER} (SUS)	$I_C = 50\text{mA}, R = 47\Omega$	325	—	375	—	425	—	Volts
I_{CBO} (1)	$V_{CB} = 80\% V_{cb}$ Rated	—	500	—	500	—	500	μA
I_{CEX} (2)	$V_{CB} = 100\% V_{cb}$ Rated, $V_{BE} = -1.5\text{V}$	—	100	—	100	—	100	μA
I_{EBO} (1)	$V_{EB} = 5.0\text{V}$	—	100	—	100	—	100	μA
I_{EBO} (2)	$V_{EB} = 7.0\text{V}$	—	50	—	50	—	50	μA
I_{CEO}	$V_{CE} = 80\% V_{CE}$ Rated	—	1.0	—	1.0	—	1.0	mA
I_{CEX}	$V_{CE} = V_{CEO}$ Rated, $V_{BE} = -1.5\text{V}, T_J = 150^\circ\text{C}$	—	3.0	—	3.0	—	3.0	mA

h_{FE}^* (1)	$V_{CE} = 5.0\text{V}, I_C = 15\text{A}$	10	—	10	—	10	—	—
h_{FE}^* (2)	$V_{CE} = 2.0\text{V}, I_C = 15\text{A}$	10	—	10	—	10	—	—
V_{CE} (sat)*	$I_C = 15\text{A}, I_B = 3\text{A}$	—	0.6	—	0.6	—	0.8	Volts
V_{BE} (sat)*	$I_C = 15\text{A}, I_B = 3\text{A}$	—	1.3	—	1.3	—	1.3	Volts

f_T	$V_{CE} = 10\text{V}, I_C = 1.0\text{A}, 10\text{MHz}$	25	75	25	75	25	75	MHz
C_{obo}	$V_{CB} = 10\text{V}, f = 1\text{MHz}$	100	300	100	300	100	300	pF

t_d	$\left\{ \begin{array}{l} V_{CC} = 200\text{V}, I_C = 15\text{A}, \\ I_{B1} = I_{B2} = 3.0\text{A}, t_p = 10\mu\text{s}, \\ \text{Duty Cycle} < 2.0\%, \text{ Resistive} \end{array} \right\}$	—	0.05	—	0.05	—	0.05	μsec
t_r		—	0.2	—	0.2	—	0.2	μsec
t_s		—	1.5	—	1.5	—	1.5	μsec
t_f		—	0.35	—	0.35	—	0.35	μsec

*Pulse measurement conditions: Length = 300 μsec , Duty Cycle < 2% (measured using separate current carrying and voltage sensing leads).

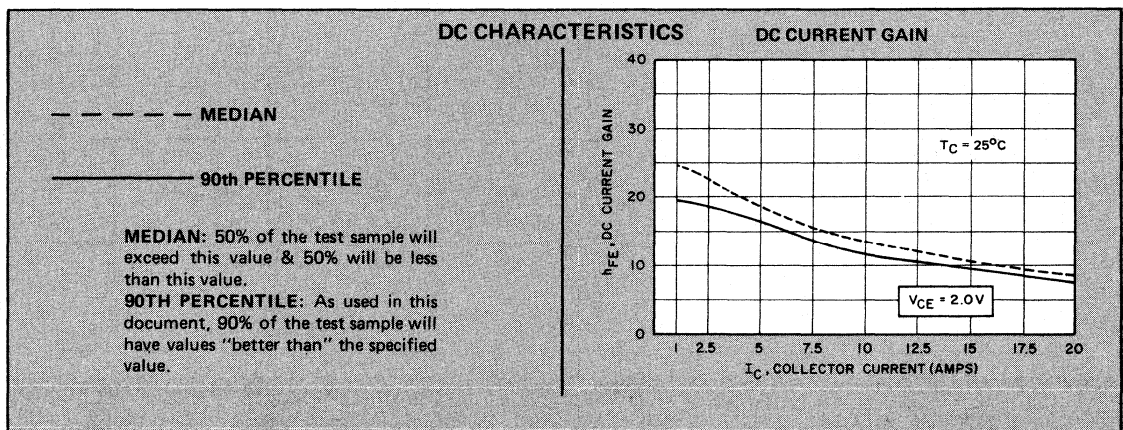

- (1) Test conditions and limits for XGSR15030, 15035, 15040
 (2) Test conditions and limits for 2N6653, 2N6654, 2N6655

DC CHARACTERISTICS

DC CURRENT GAIN

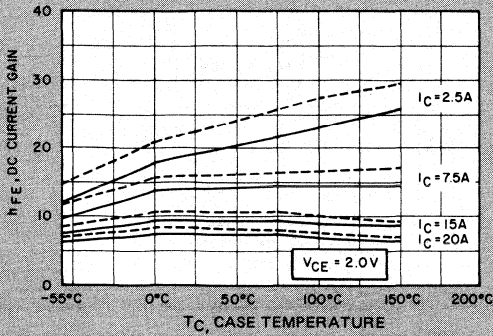

DC CURRENT GAIN

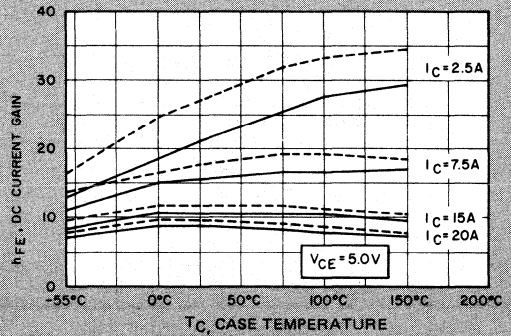

BASE EMITTER SATURATION

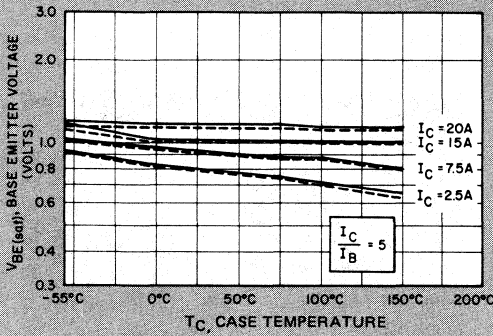

COLLECTOR SATURATION

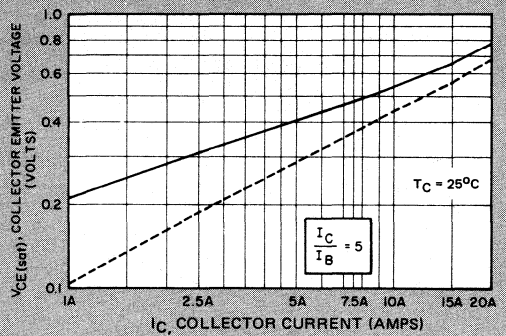

COLLECTOR SATURATION

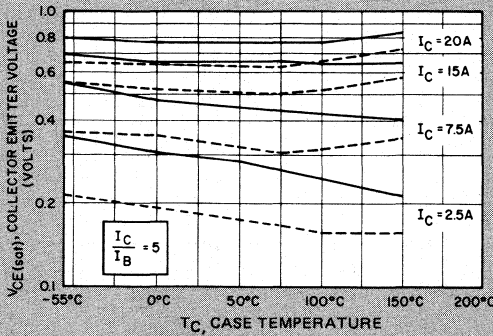

COLLECTOR SATURATION

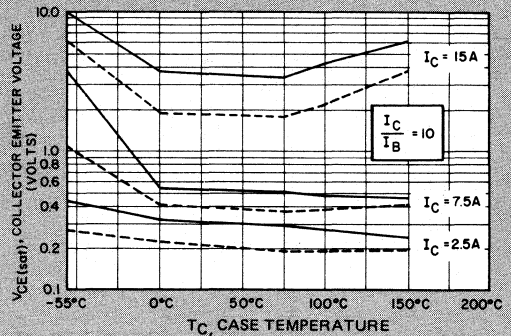

SWITCHING CHARACTERISTICS

t_s , STORAGE TIME
(RESISTIVE & INDUCTIVE)

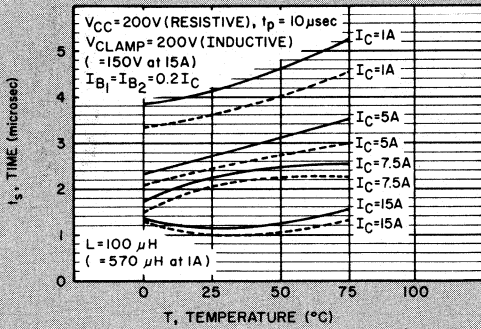

t_r , VOLTAGE RISE TIME
(TURN-OFF, INDUCTIVE)

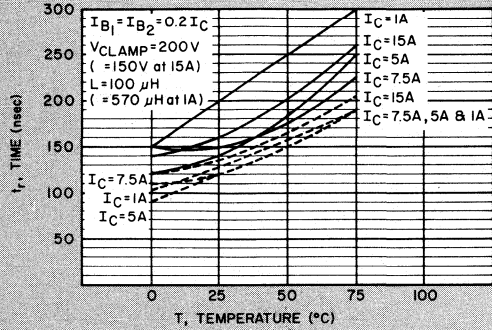

t_f , CURRENT FALL TIME
(TURN-OFF, INDUCTIVE)

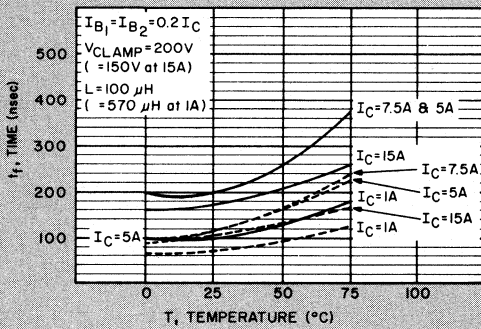

INDUCTIVE SWITCHING TURN-OFF WAVEFORM

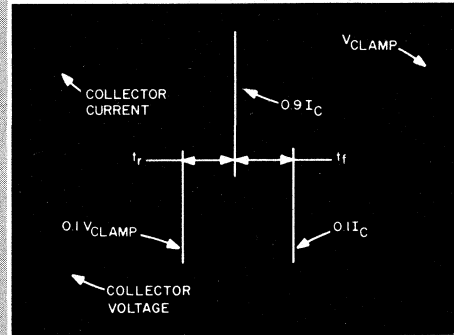

t_d , DELAY TIME
(RESISTIVE)

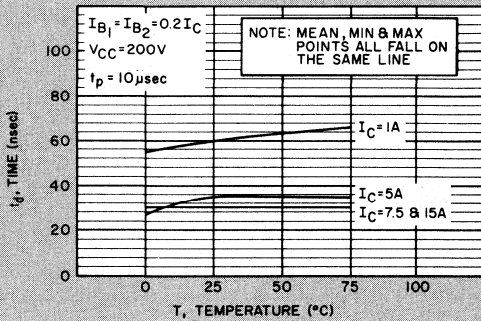

t_r , RISE TIME
(RESISTIVE)

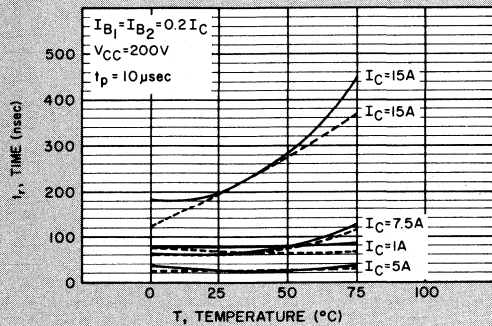

SWITCHING CHARACTERISTICS

t_f , CURRENT FALL TIME (RESISTIVE)

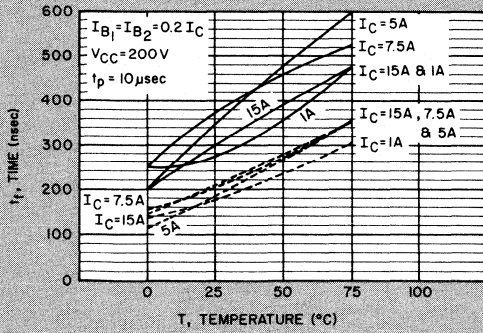

RESISTIVE SWITCHING WAVEFORM

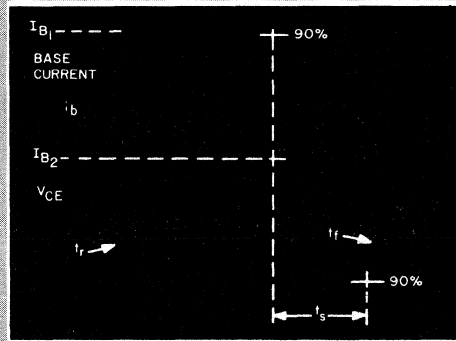

BASE DRIVE CURRENT RELATED SWITCHING CHARACTERISTICS

INDUCTIVE STORAGE TIME vs I_{B1}/I_{B2} RATIO

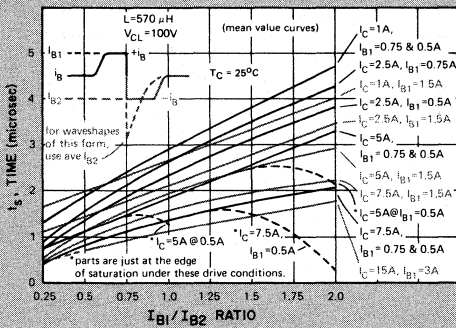

t_v , VOLTAGE RISE TIME vs I_{B1}/I_{B2} RATIO (TURN-OFF, INDUCTIVE)

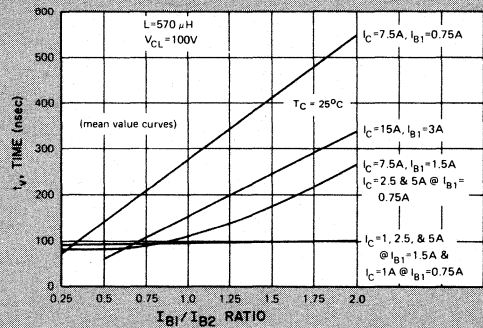

t_f , CURRENT FALL TIME vs I_{B1}/I_{B2} RATIO (TURN-OFF, INDUCTIVE)

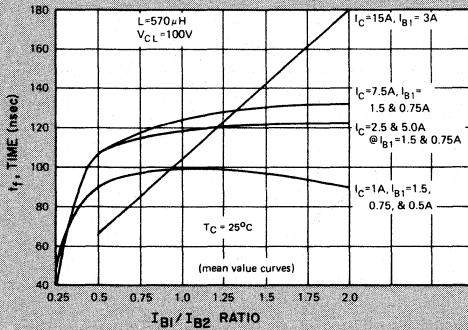

CAPACITANCE

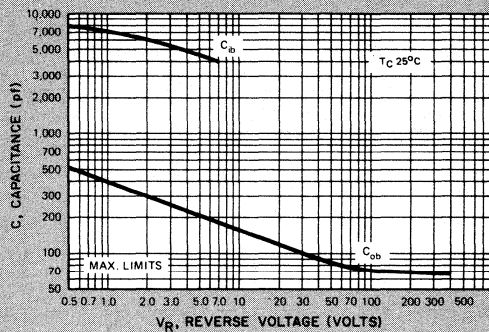

GENERAL SEMICONDUCTOR INDUSTRIES, INC.

2001 West Tenth Place, Tempe, Arizona 95281 • 602-968-3101 • TWX910-950-1942
Mailing Address: P. O. Box 3078

STORAGE & FALL TIME vs PULSE WIDTH (T_P)

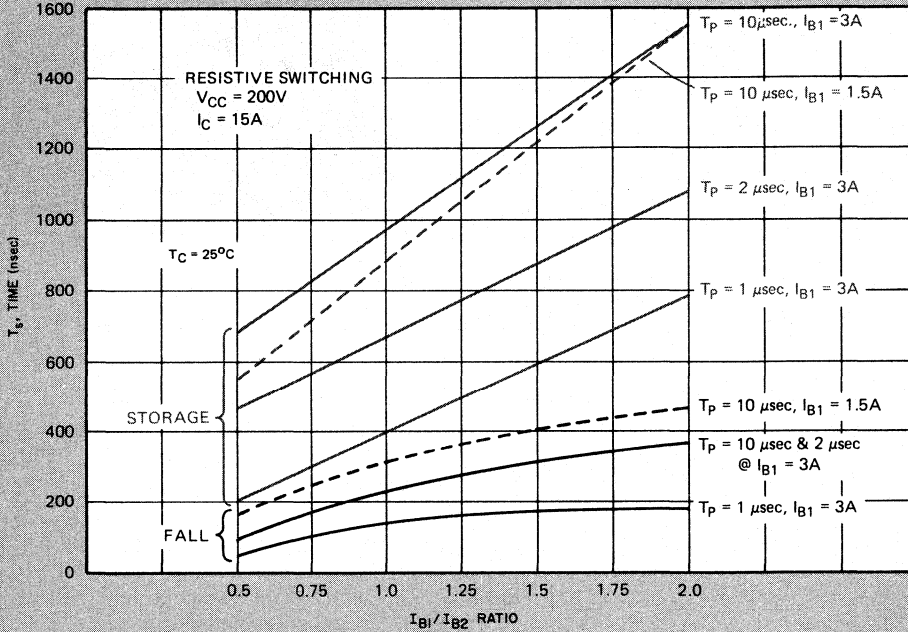

SAFE OPERATING AREA CHARACTERISTICS

TURN-OFF SAFE OPERATING AREA

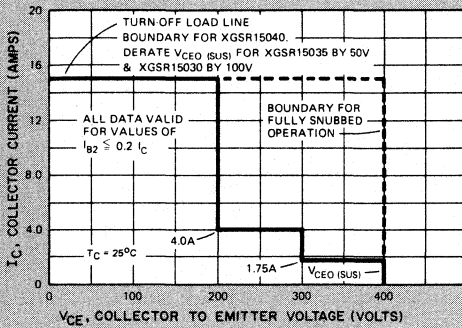

E_S/B CURVE

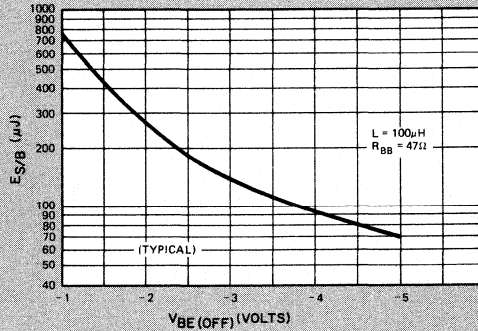

SAFE OPERATING AREA CHARACTERISTICS

FORWARD BIASED SAFE OPERATING AREA

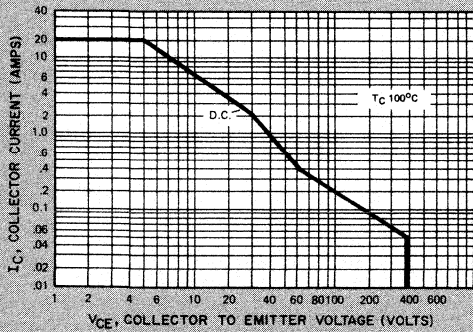

FORWARD BIASED SAFE OPERATING AREA

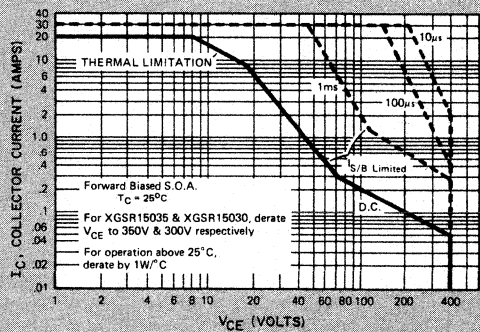

APPLICATION NOTES "Snubber" Networks

High speed switching transistors are quite often characterized by their very low $E_{S/B}$ and SOA values. In order to take advantage of the high speed performance of the XGSR series transistors it may be necessary to use load line shaping techniques. This is especially true in high energy switching regulators, converters, switching amplifiers and large inductive loads. The "turn-off" network or current "snubber" will prevent transistor degradation or failure by eliminating simultaneous occurrence of high current and high voltage at "turn-off".

Unilateral switching applications (such as flyback or series switching regulators) can be effectively snubbed with the R-C-diode snubber depicted in figure (a).

Multilateral switching applications (such as bridge and "push-pull" inverters) can be adequately snubbed by using R-C snubbers across the transformer primary as shown in

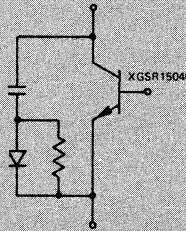

Figure a

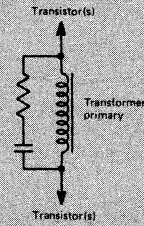

Figure b

↑
c

↑
c

TEST CIRCUITS

INDUCTIVE SWITCHING CIRCUIT

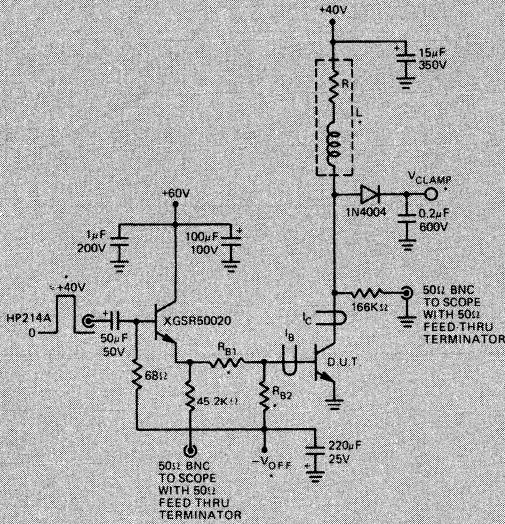

WAVEFORMS INDUCTIVE SWITCHING

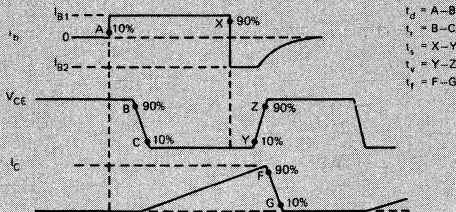

- (1) Value of L (inductor) specified on detail pages. $R_{D.C.}$ of 100μH coil is 0.29Ω; $R_{D.C.}$ of 570μH is 0.3Ω.
- (2) See Note 2 on Resistive Switching Schematic.
- (3) See Resistive Switching Schematic for measurement equipment description.

V_{CEX} TEST CIRCUIT

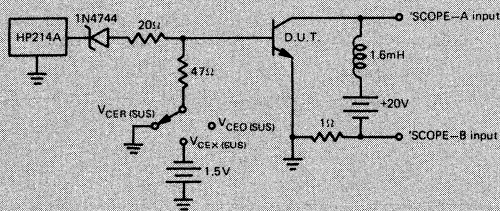

RESISTIVE SWITCHING CIRCUIT

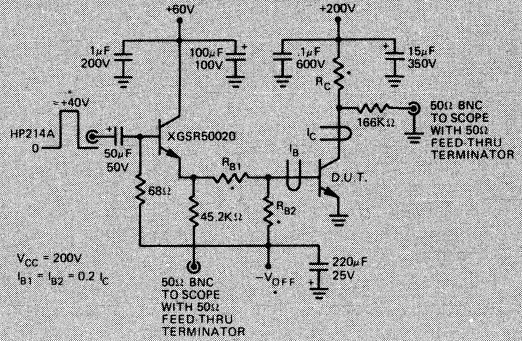

WAVEFORMS RESISTIVE SWITCHING

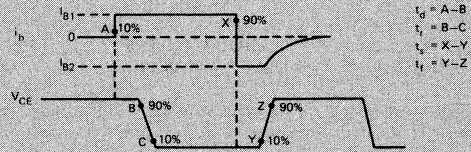

- (1) Select R_C for proper collector current @ 200V.
- (2) R_B & R_E selected such that I_{B1} & I_{B2} are the desired values for an input pulse voltage of approximately 40V & $-V_{OFF}$ level of approximately 5V.
- I_B & I_C measured with TEK P6302 current probe & AM503 amplifier.
- Scope: TEK 7834 Storage Scope, 7B92A Time Base; 7A26 dual amplifier.

PACKAGE OUTLINE TO-3

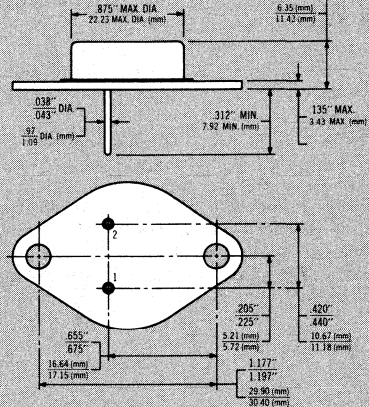

GENERAL SEMICONDUCTOR INDUSTRIES, INC.

2001 West Tenth Place, Tempe, Arizona 85281 • 602-968-3101 • TWX910-950-1942
Mailing Address: P. O. Box 3078



GENERAL
SEMICONDUCTOR
INDUSTRIES, INC.

GSDB10008

SILICON NPN TRANSISTORS

These double diffused, epitaxial collector devices are oxide passivated. They are designed for use in switching and many amplifier applications. The latest technologies are used to provide optimum performance and the highest degree of reliability.

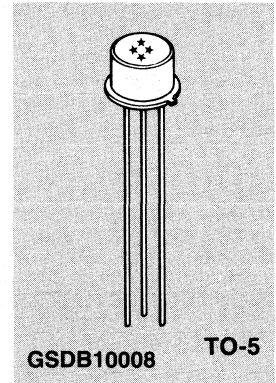

ABSOLUTE MAXIMUM RATINGS

RATINGS	SYMBOL	GSDB10008	UNIT
Collector-Base Voltage	V_{CBO}	100	Vdc
Collector-Emitter Voltage	V_{CEO}	80	Vdc
Emitter-Base Voltage	V_{EBO}	7.0	Vdc
Collector Current — Continuous	I_C	10	Adc
Base Current — Continuous	I_B	2.0	Adc
Total Power Dissipation @ 100°C	P_D	15	Watt
Thermal Resistance (Junction to Case)	θ_{J-C}	6.67	°C/W
Junction Temperature	T_J	- 65 to + 200	°C
Storage Temperature	T_{stg}	- 65 to + 200	°C

4

NPN SWITCHING
TRANSISTORS

ELECTRICAL CHARACTERISTICS (T = 25°C unless otherwise specified)

CHARACTERISTIC	SYMBOL	MIN	MAX	UNIT
----------------	--------	-----	-----	------

OFF CHARACTERISTICS

Collector-Base Voltage ($I_C = 10 \mu\text{A}$)	BV_{CBO}	100		Vdc
Collector-Emitter Voltage ($I_C = 50 \text{ MA}$)	BV_{CEO}	80		Vdc
Emitter-Base Voltage ($I_E = 10 \mu\text{A}$)	BV_{EBO}	7.0		Vdc
Collector Cutoff Current ($V_{CB} = 80 \text{ V}$)	I_{CBO}		1.0	μA
Emitter Cutoff Current ($V_{EB} = 5.0 \text{ V}$)	I_{EBO}		1.0	μA

ON CHARACTERISTICS

DC Current Gain ($V_{CE} = 5 \text{ V}, I_C = 5 \text{ A}$)	h_{FE}^*	40	160	
DC Current Gain ($V_{CE} = 5 \text{ V}, I_C = 10 \text{ A}$)	h_{FE}^*	20		
Collector Saturation Voltage ($I_C = 5 \text{ A}, I_B = 0.5 \text{ A}$)	$V_{CE(sat)}^*$		0.6	Vdc
Collector Saturation Voltage ($I_C = 10 \text{ A}, I_B = 1.0 \text{ A}$)	$V_{CE(sat)}^*$		1.0	Vdc
Base Saturation Voltage ($I_C = 10 \text{ A}, I_B = 1.0 \text{ A}$)	$V_{BE(sat)}^*$		1.5	Vdc

DYNAMIC CHARACTERISTICS

Current-Gain — Bandwidth Product ($I_C = 0.5 \text{ A}, V_{CE} = 10 \text{ V}, f = 10 \text{ MHz}$)	f_T	50		MHz
Small Signal Current Gain ($V_{CE} = 10 \text{ V}, I_C = 0.5 \text{ A}, f = 10 \text{ MHz}$)	$ h_{fe} $	5.0		
Collector Base Capacitance ($V_{CB} = 10 \text{ V}, f = 1 \text{ MHz}$)	C_{ob}		150	pF
Delay Time ($V_{CC} = 25 \text{ V}, I_C = 5 \text{ A}, I_{B1} = 0.5 \text{ A}, I_{B2} = 0.5 \text{ A}$)	t_d		0.05	μs
Rise Time ($V_{CC} = 25 \text{ V}, I_C = 5 \text{ A}, I_{B1} = 0.5 \text{ A}, I_{B2} = 0.5 \text{ A}$)	t_r		0.10	μs
Storage Time ($V_{CC} = 25 \text{ V}, I_C = 5 \text{ A}, I_{B1} = 0.5 \text{ A}, I_{B2} = 0.5 \text{ A}$)	t_s		0.75	μs
Fall Time ($V_{CC} = 25 \text{ V}, I_C = 5 \text{ A}, I_{B1} = 0.5 \text{ A}, I_{B2} = 0.5 \text{ A}$)	t_f		0.10	μs

*Pulse measurement conditions: Length = 300 μs , Duty Cycle \leq 2%.

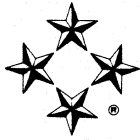

GENERAL
SEMICONDUCTOR
INDUSTRIES, INC.

GSDR10020
GSDR10025

NPN SWITCHING POWER TRANSISTORS

This unique device utilizes General Semiconductor Industries' C²R process (patent applied for) which describes a manufacturing technology that provides surface stabilization for high voltage operation and enhances long term reliability.

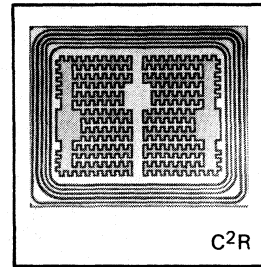
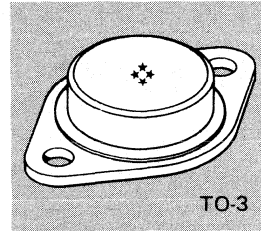

ABSOLUTE MAXIMUM RATINGS

RATINGS	SYMBOL	GSDR10020	GSDR10025	UNIT
Collector-Base Voltage	V_{CBO}	250	300	Vdc
Collector-Emitter Voltage	V_{CEO}	200	250	Vdc
Emitter-Base Voltage	V_{EBO}	7.0	7.0	Vdc
Collector Current — Continuous	I_C	15	15	Adc
Base Current — Continuous	I_B	5.0	5.0	Adc
Total Power Dissipation @ $T_C = 100^\circ\text{C}$	P_D	80	80	Watt
Thermal Resistance (Junction to Case)	θ_{J-C}	1.25	1.25	$^\circ\text{C}/\text{W}$
Junction Temperature	T_J	-65 to +200	-65 to +200	$^\circ\text{C}$
Storage Temperature	T_{stg}	-65 to +200	-65 to +200	$^\circ\text{C}$

ELECTRICAL CHARACTERISTICS (T = 25°C unless otherwise specified)

CHARACTERISTIC		SYMBOL	MIN	MAX	UNIT
OFF CHARACTERISTICS					
Collector-Base Voltage ($I_C = 1.0\text{mA}$)	GSDR10020 GSDR10025	BV_{CBO}	250 300		Vdc
Collector-Emitter Voltage ($I_C = 50\text{mA}$)	GSDR10020 GSDR10025	BV_{CEO}	200 250		Vdc
Emitter-Base Voltage ($I_E = 1.0\text{mA}$)		BV_{EBO}	7.0		Vdc
Collector-Emitter Breakdown Voltage ($I_C = 50\text{mA}$, $V_{EB} = 1.5\text{V}$)	GSDR10020 GSDR10025	BV_{CEX}	250 300		Vdc
Collector-Emitter Breakdown Voltage ($I_C = 50\text{mA}$, $R = 100\Omega$)	GSDR10020 GSDR10025	BV_{CER}	225 275		Vdc
Collector Cutoff Current ($V_{CB} = 80\%$ Rated V_{CB})		I_{CBO}		500	μA
Emitter Cutoff Current ($V_{EB} = 5.0\text{V}$)		I_{EBO}		100	μA
Collector Cutoff Current ($V_{CE} = 80\%$ Rated V_{CC})		I_{CEO}		1.0	mA

ON CHARACTERISTICS

DC Current Gain ($V_{CE} = 5.0\text{V}$, $I_C = 10\text{A}$)	h_{FE}^*	10			
Collector Saturation Voltage ($I_C = 10\text{A}$, $I_B = 2\text{A}$)	$V_{CE(\text{sat})}^*$		0.6		Vdc
Base Saturation Voltage ($I_C = 10\text{A}$, $I_B = 2\text{A}$)	$V_{BE(\text{sat})}^*$		1.5		Vdc

DYNAMIC CHARACTERISTICS

Current Gain — Bandwidth Product ($I_C = 1.0\text{A}$, $V_{CE} = 10\text{V}$, $f = 10\text{MHz}$)	f_T	25			MHz
Collector Base Capacitance ($V_{CB} = 10\text{V}$, $f = 1\text{MHz}$)	C_{ob}		200		pF
Turn-on Time ($V_{CC} = 100\text{V}$, $I_C = 10\text{A}$, $I_{B1} = 2\text{A}$, $I_{B2} = 2\text{A}$)	t_{on}		0.15		μs
Turn-off Time ($V_{CC} = 100\text{V}$, $I_C = 10\text{A}$, $I_{B1} = 2\text{A}$, $I_{B2} = 2\text{A}$)	t_{off}		1.6		μs
Storage Time ($V_{CC} = 100\text{V}$, $I_C = 10\text{A}$, $I_{B1} = 2\text{A}$, $I_{B2} = 2\text{A}$)	t_s		1.3		μs
Fall Time ($V_{CC} = 100\text{V}$, $I_C = 10\text{A}$, $I_{B1} = 2\text{A}$, $I_{B2} = 2\text{A}$)	t_f		0.3		μs

*Pulse measurement conditions: Length = 300 μs , Duty Cycle $\leq 2\%$.



**GENERAL
SEMICONDUCTOR
INDUSTRIES, INC.**

**GSDR15020
GSDR15025**

NPN SWITCHING POWER TRANSISTORS

This unique device utilizes General Semiconductor Industries' C²R process (patent applied for) which describes a manufacturing technology that provides surface stabilization for high voltage operation and enhances long term reliability.

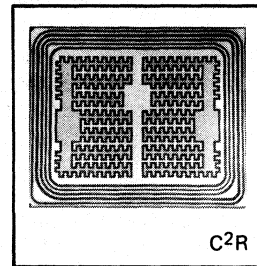
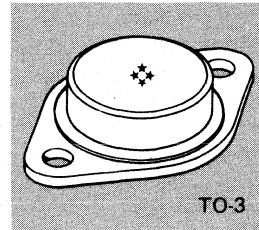

ABSOLUTE MAXIMUM RATINGS

RATINGS	SYMBOL	GSDR15020	GSDR15025	UNIT
Collector-Base Voltage	V_{CBO}	250	300	Vdc
Collector-Emitter Voltage	V_{CEO}	200	250	Vdc
Emitter-Base Voltage	V_{EBO}	7.0	7.0	Vdc
Collector Current — Continuous	I_C	20	20	Adc
Base Current — Continuous	I_B	5.0	5.0	Adc
Total Power Dissipation @ $T_C = 100^\circ\text{C}$	P_D	80	80	Watt
Thermal Resistance (Junction to Case)	θ_{J-C}	1.25	1.25	$^\circ\text{C/W}$
Junction Temperature	T_J	-65 to +200	-65 to +200	$^\circ\text{C}$
Storage Temperature	T_{stg}	-65 to +200	-65 to +200	$^\circ\text{C}$

ELECTRICAL CHARACTERISTICS (T = 25°C unless otherwise specified)

CHARACTERISTIC	SYMBOL	MIN	MAX	UNIT
----------------	--------	-----	-----	------

OFF CHARACTERISTICS

Collector-Base Voltage ($I_C = 1.0\text{mA}$)	GSDR15020 GSDR15025	BV_{CBO}	250 300	Vdc
Collector-Emitter Voltage ($I_C = 50\text{mA}$)	GSDR15020 GSDR15025	BV_{CEO}	200 250	Vdc
Emitter-Base Voltage ($I_E = 1.0\text{mA}$)		BV_{EBO}	7.0	Vdc
Collector-Emitter Breakdown Voltage ($I_C = 50\text{mA}$, $V_{BB} = 1.5\text{V}$)	GSDR15020 GSDR15025	BV_{CEX}	250 300	Vdc
Collector-Emitter Breakdown Voltage ($I_C = 50\text{mA}$, $R = 100\Omega$)	GSDR15020 GSDR15025	BV_{CER}	225 275	Vdc
Collector Cutoff Current ($V_{CB} = 80\%$ Rated V_{CB})		I_{CBO}	500	μA
Emitter Cutoff Current ($V_{EB} = 5.0\text{V}$)		I_{EBO}	100	μA
Collector Cutoff Current ($V_{CE} = 80\%$ Rated V_{CC})		I_{CEO}	1.0	μA

ON CHARACTERISTICS

DC Current Gain ($V_{CE} = 5.0\text{V}$, $I_C = 15\text{A}$)	h_{FE}^*	10		
Collector Saturation Voltage ($I_C = 15\text{A}$, $I_B = 3\text{A}$)	$V_{CE}(\text{sat})^*$		1.0	Vdc
Base Saturation Voltage ($I_C = 15\text{A}$, $I_B = 3\text{A}$)	$V_{BE}(\text{sat})^*$		1.5	Vdc

DYNAMIC CHARACTERISTICS

Current Gain — Bandwidth Product ($I_C = 1.0\text{A}$, $V_{CE} = 10\text{V}$, $f = 10\text{MHz}$)	f_T	25		MHz
Collector Base Capacitance ($V_{CB} = 10\text{V}$, $f = 1\text{MHz}$)	C_{ob}		200	pF
Turn-on Time ($V_{CC} = 100\text{V}$, $I_C = 15\text{A}$, $I_{B1} = 3.0\text{A}$, $I_{B2} = 3.0\text{A}$)	t_{on}		0.15	μs
Turn-off Time ($V_{CC} = 100\text{V}$, $I_C = 15\text{A}$, $I_{B1} = 3.0\text{A}$, $I_{B2} = 3.0\text{A}$)	t_{off}		1.2	μs
Storage Time ($V_{CC} = 100\text{V}$, $I_C = 15\text{A}$, $I_{B1} = 3.0\text{A}$, $I_{B2} = 3.0\text{A}$)	t_s		0.9	μs
Fall Time ($V_{CC} = 100\text{V}$, $I_C = 15\text{A}$, $I_{B1} = 3.0\text{A}$, $I_{B2} = 3.0\text{A}$)	t_f		0.3	μs

*Pulse measurement conditions: Length = $300\mu\text{s}$, Duty Cycle $\leq 2\%$.



**GENERAL
SEMICONDUCTOR
INDUSTRIES, INC.**

**NPN
50 AMP — 200 VOLT
GSDS50020
C²R[®]**

C²R™ HIGH SPEED/ HIGH POWER SWITCHING TRANSISTORS

The GSD series is a reliable NPN double diffused epitaxial transistor designed for high speed switching systems. This unique series utilizes General Semiconductor Industries' C²R process (patent applied for) which describes a manufacturing technology that provides surface stabilization for high voltage operation and enhances long term reliability. Another design feature is the use of an interdigitated emitter providing a periphery greater than 7.0 inches (18cm) which improves both the gain characteristics and current handling capability.

These transistors have been specifically designed and engineered for high speed/high voltage switching applications where the designer is concerned with optimizing power conversion efficiency.

In order to supply the user with a more complete definition of the C²R switching transistor capability, General Semiconductor Industries has attempted to furnish a data sheet with a thorough and meaningful technical dialogue.

FEATURES:

- HIGH VOLTAGE
- HIGH GAIN
- HIGH CURRENT
- LOW SATURATION VOLTAGES
- FAST SWITCHING
- RADIATION RESISTANT

APPLICATIONS:

- HIGH SPEED SWITCHING
- POWER CONVERSION
- CONVERTERS
- INVERTERS
- CLASS D AMPLIFIERS
- CLASS C AMPLIFIERS

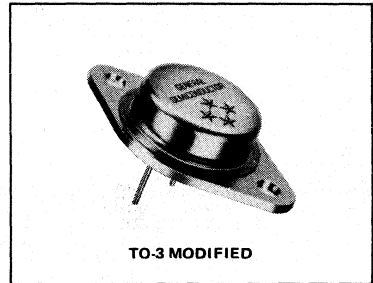

TO-3 MODIFIED

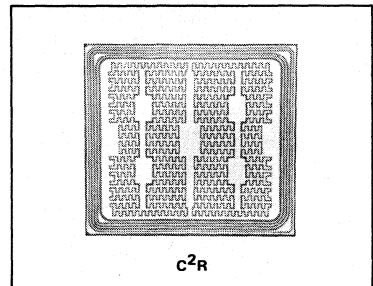

C²R

**4
NPN SWITCHING
TRANSISTORS**

V_{CE(sat)} at 50 AMPS typically 0.6V

MAXIMUM RATINGS (T_J = 25°C unless otherwise noted)			
RATING	SYMBOL	GSDS50020	UNIT
Collector-Base Voltage	V _{CB0}	200	Volts
Collector-Emitter Voltage	V _{CEO (SUS)}	200	Volts
Emitter-Base Voltage	V _{EB0}	7.0	Volts
Collector Current — Continuous	I _C	50	Amps
Peak	I _{CM}	100	Amps
Base Current — Continuous	I _B	20	Amps
Total Power Dissipation @ T _C = 100°C	P _D	100	Watts
Θ _{J-C} , Junction to Case Thermal Resistance	R _{ΘJC}	1.0	°C/W
Operating and Storage Junction Temperature Range	T _{J (oper)} & T _{stg}	-65 to +200	°C

GLOSSARY OF TERMS

I_C: CONTINUOUS COLLECTOR CURRENT: No industry standard for selection of this parameter exists. General Semiconductor Industries specifies a level which is based on practical, useable values of current gain & collector-emitter saturation voltage.

DOUBLE DIFFUSED EPITAXIAL: Defines the structure of the Silicon die. The Collector is deposited epitaxially on low resistivity silicon, followed by a base diffusion and an emitter diffusion.

INTERDIGITATED EMITTER: This is a Geometric method for achieving long emitter peripheries in limited base areas.

C²R™: A trademark of General Semiconductor Industries for Charge Control Rings, a structure which enhances breakdown and provides surface stabilization in shallow diffused, oxide passivated structures.

(Continued on Page 2)

GENERAL SEMICONDUCTOR INDUSTRIES, INC.

2001 West Tenth Place, Tempe, Arizona 85281 • 602-968 3101 • TWX910 950 1942
Mailing Address: P. O. Box 3078

GENERAL SEMICONDUCTOR INDUSTRIES, INC.

ELECTRICAL CHARACTERISTICS ($T_J = 25^{\circ}\text{C}$ unless otherwise noted)				
		GSDS50020		
SYMBOL	CONDITIONS	Min	Max	UNIT
V_{CBO}	$I_C = 1.0\text{mA}$	200	—	Volts
V_{CEO} (SUS)	$I_C = 50\text{mA}$	200	—	Volts
V_{EBO}	$I_E = 1.0\text{mA}$	7.0	—	Volts

I_{EBO}	$V_{EB} = 6.0\text{V}$	—	100	μA
I_{CEO}	$V_{CE} = 150\text{V}$	—	50	μA
I_{CEX}	$V_{CE} = 200\text{V}, V_{BE} = -1.5\text{V}$	—	10.0	μA
$E_{S/B}$	$L = 50\mu\text{H}, V_{BE}(\text{OFF}) = -1\text{V}, R_{BB} = 47\Omega$	750	—	μJ

h_{FE}^*	$V_{CE} = 4.0\text{V}, I_C = 50\text{A}$	8	—	—
$V_{CE}(\text{sat})^*$	$I_C = 50\text{A}, I_B = 10\text{A}$	—	1.0	Volts
$V_{BE}(\text{sat})^*$	$I_C = 50\text{A}, I_B = 10\text{A}$	—	2.0	Volts

$ h_{fe} $	$V_{CE} = 10\text{V}, I_C = 1.0\text{A}, f = 10\text{MHz}$	3.0	—	—
C_{obo}	$V_{CB} = 10\text{V}, f = 1\text{MHz}$	—	350	pF

t_d	$V_{CC} = 100\text{V}, I_C = 50\text{A},$ $I_{B1} = I_{B2} = 10\text{A}, t_p = 10\mu\text{s},$ Duty Cycle $< 2.0\%$, Resistive Load.	—	0.04	μsec
t_r		—	0.2	μsec
t_s		—	0.75	μsec
t_f		—	0.175	μsec

*Pulse measurement conditions: Length = 300 μsec , Duty Cycle $< 2\%$
(measured using separate current carrying and voltage sensing leads).

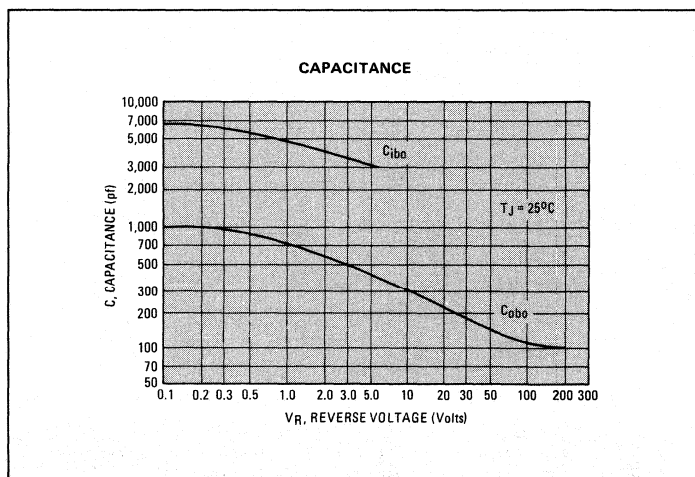

GLOSSARY OF TERMS — cont'd.

SECOND BREAKDOWN LIMIT: $I_{S/B}$, $E_{S/B}$, & Turn-off S/B . These terms describe the voltage-current stress limits which cause device failure whereby the collector-base voltage collapses to an extremely low value and allows an uncontrolled high current flow.

SAFE OPERATING AREA: This term specifies operating boundaries beyond which device damage, or destruction, can occur.

FORWARD BIASED SAFE OPERATING AREA: The maximum simultaneous voltage & current that the transistor can withstand in its "on" condition, for the specified time duration. $I_{S/B}$ is included in this region.

$E_{S/B}$: The limit of energy the transistor can withstand when the collector-to-emitter is forced to draw current at its avalanche breakdown voltage, with some specified value of reverse base drive.

TURN-OFF SAFE OPERATING AREA: A coined term, used to describe the dynamic stress limits that can be safely handled during device turn-off. The boundaries of this area are established by $I_{C(\text{cont})}$, V_{CEO} (SUS), and the peak instantaneous power that the transistor can safely withstand during the "turn-off" transition (turn-off S/B). Increased I_{B2} usually causes a decrease in the "safe" value of peak instantaneous power.

I_{B1} : Forward base current during transistor "on" time.

I_{B2} : Reverse base current during the transition from the "on" state to the "off" state.

SNUBBING: Circuit techniques, used to retard the voltage rise in respect to the current fall during "turn-off," thereby reducing the peak instantaneous power, protecting the transistor & reducing device power dissipation. Similarly, the current rise time can be retarded in respect to the voltage fall during "turn-on," further reducing transistor dissipation.

MEDIAN: 50% of the test sample will exceed this value & 50% will be less than this value.

90TH PERCENTILE: As used in this document, 90% of the test sample will have values "better than" the specified value.

t_p : Pulse time/pulse duration.

h_{fe} : Magnitude of common emitter, small signal, short circuit, forward current transfer ratio.

h_{FE} : Static, forward current transfer ratio, common emitter.

C_{ibo} : Input capacitance, common base, collector open circuit.

C_{obo} : Output capacitance, common base, emitter open circuit.

V_{CC} : Collector supply voltage.

DOTTED LINES – MEDIAN
SOLID LINES – 90TH PERCENTILE

DC CHARACTERISTICS

DC CURRENT GAIN

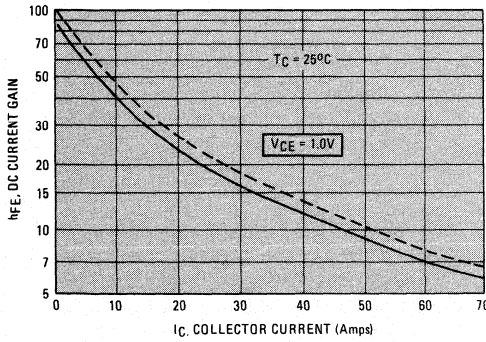

COLLECTOR SATURATION

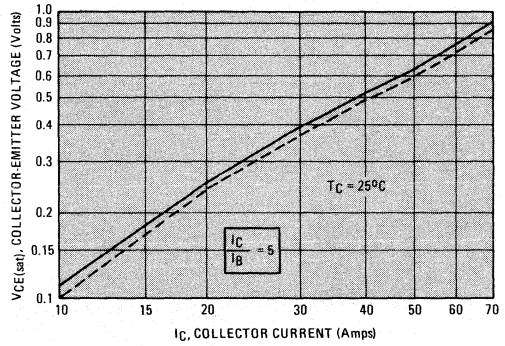

DC CURRENT GAIN

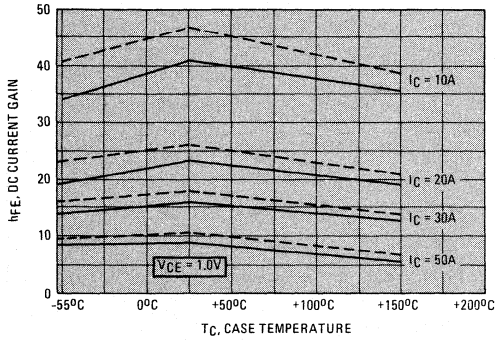

BASE-EMITTER SATURATION

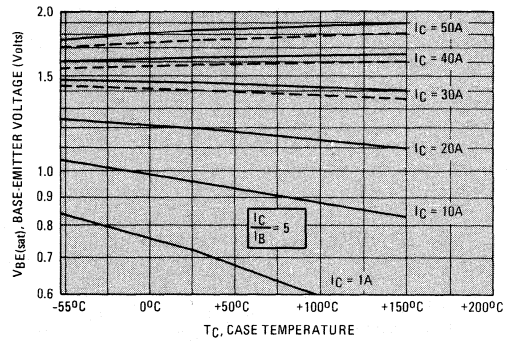

COLLECTOR SATURATION

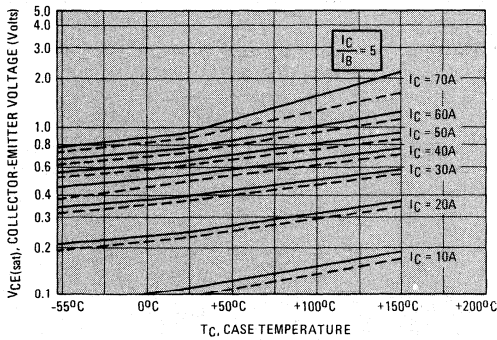

COLLECTOR SATURATION

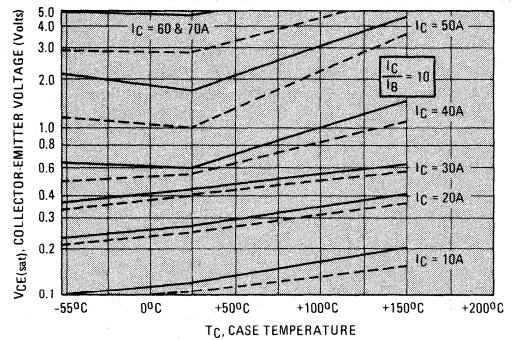

4

NPN SWITCHING
TRANSISTORS



GENERAL SEMICONDUCTOR INDUSTRIES, INC.

2001 West Tenth Place, Tempe, Arizona 85281 • 602-968-3101 • TWX910-950-1942
Mailing Address: P.O. Box 3078

GENERAL SEMICONDUCTOR INDUSTRIES, INC.

DOTTED LINES – MEDIAN
SOLID LINES – 90TH PERCENTILE

RESISTIVE SWITCHING

t_d , DELAY TIME

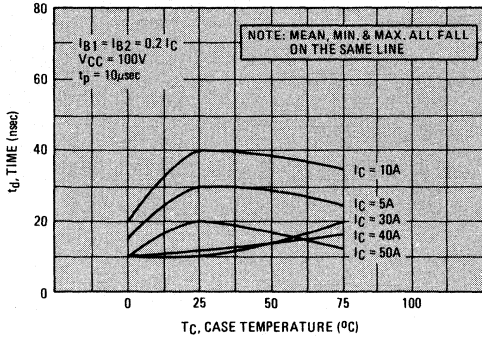

t_r , RISE TIME

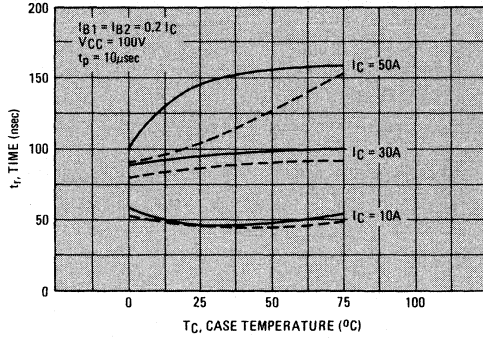

t_s , STORAGE TIME

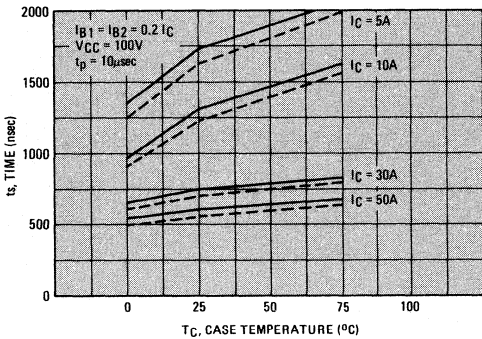

t_f , FALL TIME

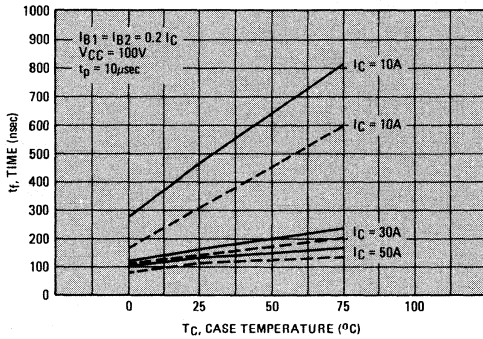

t_s , STORAGE TIME
VS. I_C & I_{B1}/I_{B2} RATIO

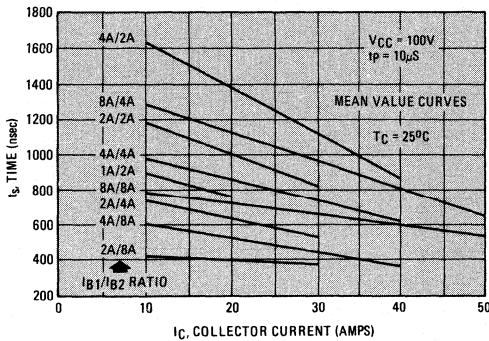

BASE DRIVE EFFECTS (RESISTIVE SWITCHING)

t_f , FALL TIME
VS. I_{B1}/I_{B2} RATIO

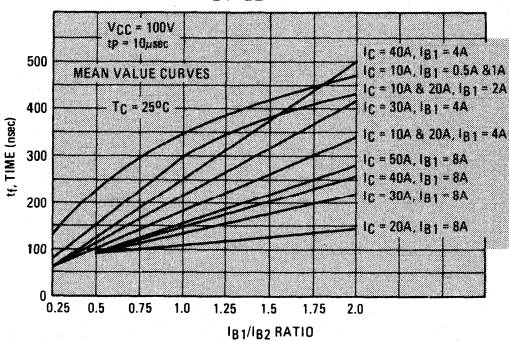

GENERAL SEMICONDUCTOR INDUSTRIES, INC.

WAVEFORMS RESISTIVE SWITCHING

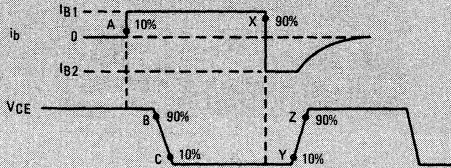

$$t_d = A - B$$

$$t_r = B - C$$

$$t_s = X - Y$$

$$t_f = Y - Z$$

PACKAGE OUTLINE TO-3 MODIFIED*

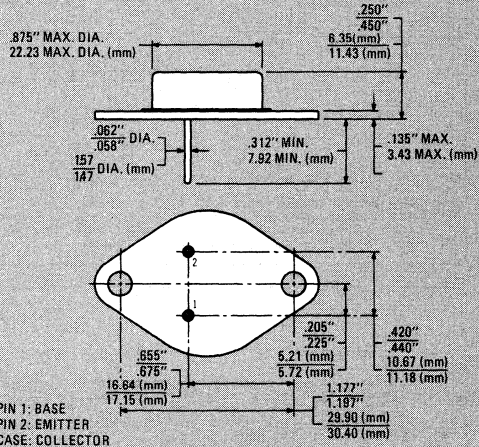

* Available as standard TO-3 with 0.040" pins.
Contact factory for further information.

APPLICATION NOTES "Snubber" Networks

High speed switching transistors are quite often characterized by their very low E_S/B and SOA values. In order to take advantage of the high speed performance of the GSD series transistors it may be necessary to use load line shaping techniques. This is especially true in high energy switching regulators, converters, switching amplifiers and large inductive loads. The "turn-off" network or current "snubber" will prevent transistor degradation or failure by eliminating simultaneous occurrence of high current and high voltage at "turn-off".

Unilateral switching applications (such as flyback or series switching regulators) can be effectively snubbed with the R-C diode snubber depicted in figure (a).

Multilateral switching applications (such as bridge and "push-pull" inverters) can be adequately snubbed by using R-C snubbers across the transformer primary as shown in figure (b).

Proper snubber design will minimize dissipative losses at turn-off while affording the transistor a considerably "safer" turn-off load line (figure c).

Further information on load line shaping including design aids are included in General Semiconductor Industries' Application Note titled *Methods For Utilizing High Speed Switching Transistors In High Energy Switching Environments* by William Skanadore.

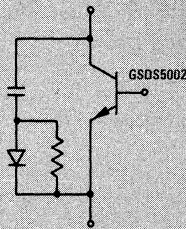

Figure a

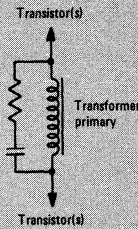

Figure b

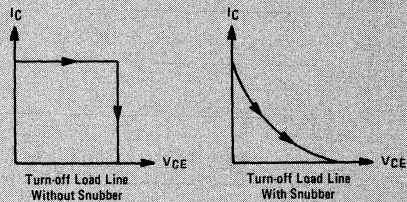

Figure c



GENERAL SEMICONDUCTOR INDUSTRIES, INC.

2001 West Tenth Place, Tempe, Arizona 85281 • 602-968-3101 • TWX910-950-1942
Mailing Address: P.O. Box 3078



GENERAL
SEMICONDUCTOR
INDUSTRIES, INC.

GSTU 4030
GSTU 4035
GSTU 4040

C²R HIGH SPEED/HIGH POWER SWITCHING TRANSISTORS

The GST series is a NPN triple diffused transistor designed for high speed switching systems. This unique series utilizes General Semiconductor Industries' C²R process which describes a manufacturing technology that provides surface stabilization for high voltage operation and enhances long term reliability.

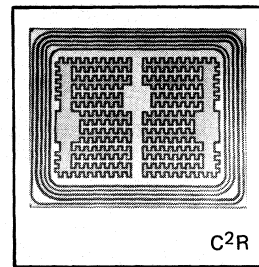
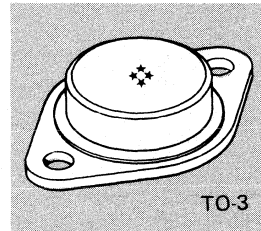

ABSOLUTE MAXIMUM RATINGS

RATINGS	SYMBOL	GSTU4030	GSTU4035	GSTU4040	UNIT
Collector-Base Voltage	V_{CBO}	350	400	450	Vdc
Collector-Emitter Voltage	V_{CEO}	300	350	400	Vdc
Emitter-Base Voltage	V_{EBO}	7.0	7.0	7.0	Vdc
Collector Current — Continuous	I_C	6.0	6.0	6.0	Adc
Base Current — Continuous	I_B	3.0	3.0	3.0	Adc
Total Power Dissipation @ $T_C = 25^\circ\text{C}$	P_D	125	125	125	Watt
Thermal Resistance (Junction to Ambient)	θ_{J-C}	1.2	1.2	1.2	$^\circ\text{C}/\text{W}$
Junction Temperature	T_J	-65 to +175	-65 to +175	-65 to +175	$^\circ\text{C}$
Storage Temperature	T_{stg}	-65 to +175	-65 to +175	-65 to +175	$^\circ\text{C}$

4

NPN SWITCHING
TRANSISTORS

ELECTRICAL CHARACTERISTICS (T = 25°C unless otherwise specified)

CHARACTERISTIC		SYMBOL	MIN	MAX	UNIT
OFF CHARACTERISTICS					
Collector-Emitter Voltage ($I_C = 50\text{mA}$)	GSTU4030 GSTU4035 GSTU4040	BV_{CEO}	300 350 400		Vdc
Collector Cutoff Current ($V_{CB} = 80\%$ Rated V_{CB})		I_{CBO}		1000	μA
Emitter Cutoff Current ($V_{EB} = 7.0\text{V}$)		I_{EBO}		1000	μA
Collector Cutoff Current ($V_{CE} = \text{Rated } V_{CE}$)		I_{CEO}		100	μA
Collector Cutoff Current ($V_{CB} = \text{Rated } V_{CB}$)		I_{CBO}		500	μA
Emitter Cutoff Current ($V_{EB} = 5.0\text{V}$)		I_{EBO}		100	μA

ON CHARACTERISTICS

DC Current Gain ($V_{CE} = 5.0\text{V}$, $I_C = 4\text{A}$)		h_{FE}^*	10		
Collector Saturation Voltage ($I_C = 4\text{A}$, $I_B = 0.8\text{A}$)		$V_{CE(\text{sat})}^*$		0.8	Vdc
Base Saturation Voltage ($I_C = 4\text{A}$, $I_B = 0.8\text{A}$)		$V_{BE(\text{sat})}^*$		1.3	Vdc

DYNAMIC CHARACTERISTICS

Small Signal Current Gain ($V_{CE} = 10\text{V}$, $I_C = 500\text{mA}$, $f = 10\text{MHz}$)		$ h_{fe} $	2.5		MHz
Collector Base Capacitance ($V_{CB} = 10\text{V}$)		C_{ob}		150	pF
Delay Time ($V_{CC} = 200\text{V}$, $I_C = 4\text{A}$, $I_{B1} = 0.8\text{A}$, $I_{B2} = 0.8\text{A}$)		t_d		0.07	μs
Rise Time ($V_{CC} = 200\text{V}$, $I_C = 4\text{A}$, $I_{B1} = 0.8\text{A}$, $I_{B2} = 0.8\text{A}$)		t_r		0.300	μs
Storage Time ($V_{CC} = 200\text{V}$, $I_C = 4\text{A}$, $I_{B1} = 0.8\text{A}$, $I_{B2} = 0.8\text{A}$)		t_s		3.0	μs
Fall Time ($V_{CC} = 200\text{V}$, $I_C = 4\text{A}$, $I_{B1} = 0.8\text{A}$, $I_{B2} = 0.8\text{A}$)		t_f		0.700	μs

*Pulse measurement conditions: Length = 300 μs , Duty Cycle $\leq 2\%$.



GENERAL
SEMICONDUCTOR
INDUSTRIES, INC.

GSTU 6030
GSTU 6035
GSTU 6040

SILICON NPN TRANSISTORS

These double diffused, epitaxial collector devices are oxide passivated. They are designed for use in switching and many amplifier applications. The latest technologies are used to provide optimum performance and the highest degree of reliability.

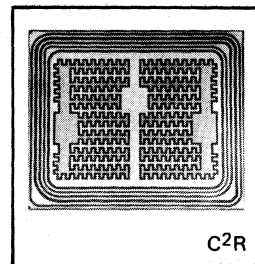
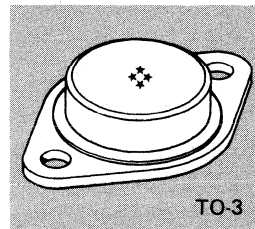

ABSOLUTE MAXIMUM RATINGS

RATINGS	SYMBOL	GSTU6030	GSTU6035	GSTU6040	UNIT
Collector-Base Voltage	V_{CBO}	350	400	450	Vdc
Collector-Emitter Voltage	V_{CEO}	300	350	400	Vdc
Emitter-Base Voltage	V_{EBO}	7.0	7.0	7.0	Vdc
Collector Current — Continuous	I_C	10	10	10	Adc
Base Current — Continuous	I_B	5.0	5.0	5.0	Adc
Total Power Dissipation @ $T_C = 25^\circ\text{C}$	P_D	125	125	125	Watt
Thermal Resistance (Junction to Case)	θ_{J-C}	1.2	1.2	1.2	$^\circ\text{C}/\text{W}$
Junction Temperature	T_J	-65 to +175	-65 to +175	-65 to +175	$^\circ\text{C}$
Storage Temperature	T_{stg}	-65 to +175	-65 to +175	-65 to +175	$^\circ\text{C}$

4

NPN SWITCHING
TRANSISTORS

ELECTRICAL CHARACTERISTICS (T = 25°C unless otherwise specified)

CHARACTERISTIC	SYMBOL	MIN	MAX	UNIT
----------------	--------	-----	-----	------

OFF CHARACTERISTICS

Collector-Base Voltage ($I_C = 1.0\text{mA}$)	GSTU6030 GSTU6035 GSTU6040	BV_{CBO}	350 400 450	Vdc
Collector-Emitter Voltage ($I_C = 50\text{mA}$)	GSTU6030 GSTU6035 GSTU6040	BV_{CEO}	300 350 400	Vdc
Emitter-Base Voltage ($I_E = 1.0\text{mA}$)		BV_{EBO}	7.0	Vdc
Collector Cutoff Current ($V_{CB} = 80\%$ Rated V_{CB})		I_{CBO}	500	μA
Emitter Cutoff Current ($V_{EB} = 5.0\text{V}$)		I_{EBO}	100	μA

ON CHARACTERISTICS

DC Current Gain ($V_{CE} = 5.0\text{V}$, $I_C = 6\text{A}$)		h_{FE}^*	10	
Collector Saturation Voltage ($I_C = 6\text{A}$, $I_B = 1.2\text{A}$)		$V_{CE(sat)}^*$	0.8	Vdc
Base Saturation Voltage ($I_C = 6\text{A}$, $I_B = 1.2\text{A}$)		$V_{BE(sat)}^*$	1.3	Vdc

DYNAMIC CHARACTERISTICS

Current Gain — Bandwidth Product ($I_C = 500\text{mA}$, $V_{CE} = 10\text{V}$, $f = 10\text{MHz}$)		f_T	25	MHz
Collector Base Capacitance ($V_{CB} = 10\text{V}$, $f = 1\text{MHz}$)		C_{ob}	150	pF
Delay Time ($V_{CC} = 200\text{V}$, $I_C = 6\text{A}$, $I_{B1} = 1.2\text{A}$, $I_{B2} = 1.2\text{A}$)		t_d	0.05	μs
Rise Time ($V_{CC} = 200\text{V}$, $I_C = 6\text{A}$, $I_{B1} = 1.2\text{A}$, $I_{B2} = 1.2\text{A}$)		t_r	.2	μs
Storage Time ($V_{CC} = 200\text{V}$, $I_C = 6\text{A}$, $I_{B1} = 1.2\text{A}$, $I_{B2} = 1.2\text{A}$)		t_s	2.0	μs
Fall Time ($V_{CC} = 200\text{V}$, $I_C = 6\text{A}$, $I_{B1} = 1.2\text{A}$, $I_{B2} = 1.2\text{A}$)		t_f	.5	μs

*Pulse measurement conditions: Length = 300 μs , Duty Cycle $\leq 2\%$.



**GENERAL
SEMICONDUCTOR
INDUSTRIES, INC.**

NPN
350, 400, 450V
8 Amp
GSTU8035, 40, 45
C²R™

C²R HIGH SPEED/HIGH POWER SWITCHING TRANSISTORS

The GST series is a NPN triple diffused transistor designed for high speed switching systems. This unique series utilizes General Semiconductor Industries' C²R process which describes a manufacturing technology that provides surface stabilization for high voltage operation and enhances long term reliability.

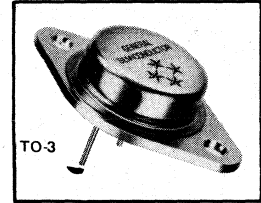

MAXIMUM RATINGS (T _J = 25°C unless otherwise noted)					
RATING	SYMBOL	GSTU8035	GSTU8040	GSTU8045	UNIT
Collector-Base Voltage	V _{CBO}	400	450	500	Volts
Collector-Emitter Voltage	V _{CEO}	350	400	450	Volts
Emitter-Base Voltage	V _{EBO}	7.0	7.0	7.0	Volts
Collector Current - Continuous	I _C	12	12	12	Amps
Peak	I _{CM}	20	20	20	Amps
Base Current-Continuous	I _B	6	6	6	Amps
Total Power Dissipation @ T _C = 25°C	P _D	188	188	188	Watts
θ _{J-c} , Junction to Case Thermal Resistance	R _{θJC}	0.8	0.8	0.8	°C/W
Operating and Storage Junction Temperature Range	T _{J (oper)} T _{stg}	-65 to +175 -65 to +200	-65 to +175 -65 to +200	-65 to +175 -65 to +200	°C °C

ELECTRICAL CHARACTERISTICS (T _J = 25°C unless otherwise noted)									
		GSTU8035		GSTU8040		GSTU8045			
SYMBOL	CONDITIONS	Min	Max	Min	Max	Min	Max	UNIT	
V _{CBO}	I _C = 1.0mA	400	—	450	—	500	—	Volts	
V _{CEO}	I _C = 50mA	350	—	400	—	450	—	Volts	
V _{EBO}	I _E = 1.0mA	7.0	—	7.0	—	7.0	—	Volts	
I _{CBO}	V _{CB} = 80% V _{cb} Rated	—	500	—	500	—	500	μA	
I _{EBO}	V _{EB} = 5.0V	—	100	—	100	—	100	μA	
h _{FE} *	V _{CE} = 5.0V, I _C = 8.0A	10	—	10	—	10	—	—	
V _{CE (sat)} *	I _C = 8A, I _B = 1.6A	—	0.8	—	0.8	—	0.8	Volts	
V _{BE (sat)} *	I _C = 8A, I _B = 1.6A	—	1.3	—	1.3	—	1.3	Volts	
f _T	V _{CE} = 10V, I _C = 1.0A	25	—	25	—	25	—	MHz	
C _{obo}	V _{CB} = 10V, f = 1MHz	—	300	—	300	—	300	pF	
t _d	{ V _{CC} = 200V, I _C = 8A, I _{B1} = I _{B2} = 1.6A, t _p = 10μs, Duty Cycle < 2.0%, Resistive }	—	0.050	—	0.050	—	0.050	μsec	
t _r		—	0.100	—	0.100	—	0.100	μsec	
t _s		—	2.7	—	2.7	—	2.7	μsec	
t _f		—	0.470	—	0.35	—	0.470	μsec	

*Pulse measurement conditions: Length = 300 μsec, Duty Cycle < 2% (measured using separate current carrying and voltage sensing leads).



GENERAL SEMICONDUCTOR INDUSTRIES, INC.

2001 West Tenth Place, Tempe, Arizona 85281 • 602 968 3101 • TWX910 950 1942
Mailing Address: P.O. Box 3078

™C²R is a Registered Trademark of General Semiconductor Industries, Inc.

DC CHARACTERISTICS

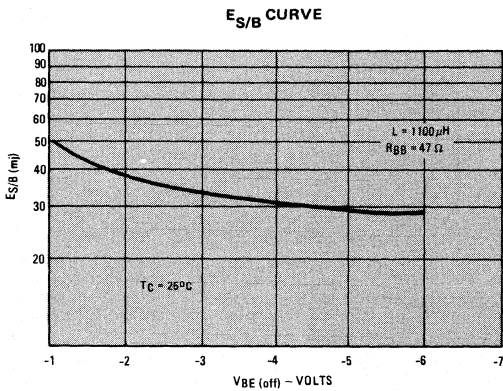
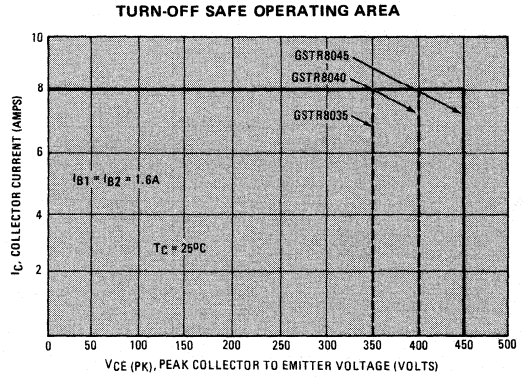
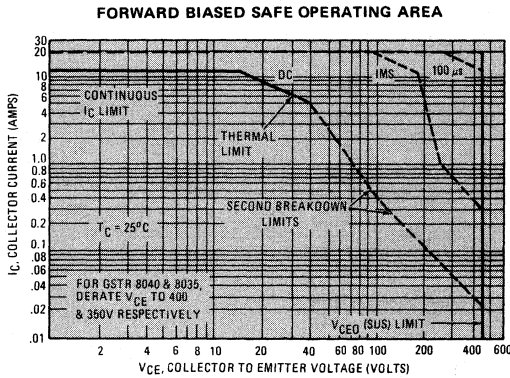
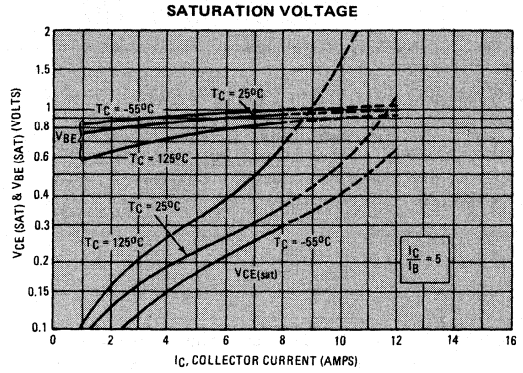
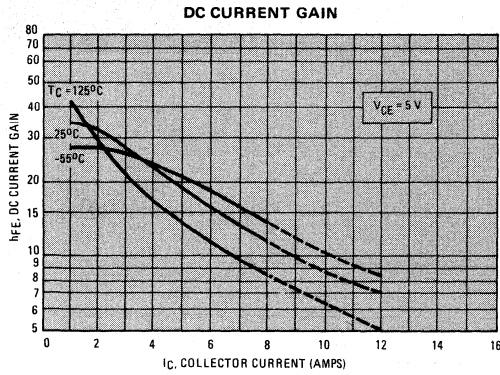

PACKAGE OUTLINE

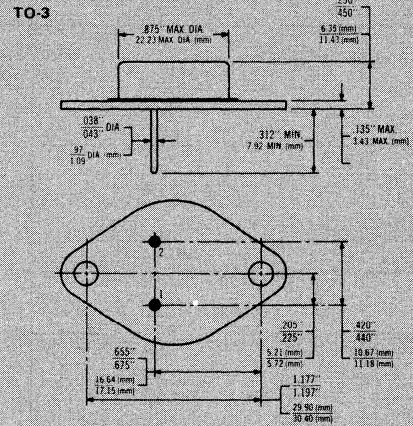

GENERAL SEMICONDUCTOR INDUSTRIES, INC.

2001 West Tenth Place, Tempe, Arizona 85281 • 602 968 3101 • TWX910 950 1942
Mailing Address: P.O. Box 3078



**GENERAL
SEMICONDUCTOR
INDUSTRIES, INC.**

**NPN
300, 350, 400V
12 Amp
GSTU12030, 35, 40
C²R[®]**

C²R HIGH SPEED/HIGH POWER SWITCHING TRANSISTORS

The GST series is a NPN triple diffused transistor designed for high speed switching systems. This unique series utilizes General Semiconductor Industries' C²R process which describes a manufacturing technology that provides surface stabilization for high voltage operation and enhances long term reliability.

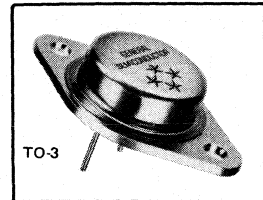

MAXIMUM RATINGS (T _J = 25°C unless otherwise noted)					
RATING	SYMBOL	GSTU12030	GSTU12035	GSTU12040	UNIT
Collector-Base Voltage	V _{CBO}	350	400	450	Volts
Collector-Emitter Voltage	V _{CEO}	300	350	400	Volts
Emitter-Base Voltage	V _{EBO}	7.0	7.0	7.0	Volts
Collector Current - Continuous	I _C	16	16	16	Amps
Peak	I _{CM}	25	25	25	Amps
Base Current-Continuous	I _B	8	8	8	Amps
Total Power Dissipation @T _C = 25°C	P _D	188	188	188	Watts
θ _{J-C} , Junction to Case Thermal Resistance	R _{θJC}	0.8	0.8	0.8	°C/W
Operating and Storage Junction Temperature Range	T _{J (oper)} T _{stg}	-65 to +175 -65 to +200	-65 to +175 -65 to +200	-65 to +175 -65 to +200	°C °C

ELECTRICAL CHARACTERISTICS (T _J = 25°C unless otherwise noted)								
		GSTU12030		GSTU12040		GSTU12035		
SYMBOL	CONDITIONS	Min	Max	Min	Max	Min	Max	UNIT
V _{CBO}	I _C = 1.0mA	350	—	400	—	450	—	Volts
V _{CEO}	I _C = 50mA	300	—	350	—	400	—	Volts
V _{EBO}	I _E = 1.0mA	7.0	—	7.0	—	7.0	—	Volts
I _{CBO}	V _{CB} = 80% V _{cb} , Rated	—	500	—	500	—	500	μA
I _{EBO}	V _{EB} = 5.0V	—	100	—	100	—	100	μA
h _{FE} *	V _{CE} = 5.0V, I _C = 12A	10	—	10	—	10	—	—
V _{CE (sat)} *	I _C = 12A, I _B = 2.4 A	—	0.8	—	0.8	—	0.8	Volts
V _{BE (sat)} *	I _C = 12A, I _B = 2.4 A	—	1.3	—	1.3	—	1.3	Volts
f _T	V _{CE} = 10V, I _C = 1.0 A	25	—	25	—	25	—	MHz
C _{obo}	V _{CB} = 10V, f = 1MHz	—	300	—	300	—	300	pF
t _d	{ V _{CC} = 200V, I _C = 12A, I _{B1} = I _{B2} = 2.4A, t _p = 10μs Duty Cycle <2.0%, Resistive }	—	0.050	—	0.050	—	0.050	μsec
t _r		—	0.200	—	0.200	—	0.200	μsec
t _s		—	1.8	—	1.8	—	1.8	μsec
t _f		—	0.470	—	0.470	—	0.470	μsec

*Pulse measurement conditions: Length = 300 μsec, Duty Cycle < 2% (measured using separate current carrying and voltage sensing leads).

4

NPN SWITCHING TRANSISTORS



GENERAL SEMICONDUCTOR INDUSTRIES, INC.

2001 West Tenth Place, Tempe, Arizona 85281 • 602 968 3101 • TWX910-950 1942
Mailing Address: P.O. Box 3078

™ C²R is a Registered Trademark of General Semiconductor Industries, Inc.

DC CHARACTERISTICS

DC CURRENT GAIN

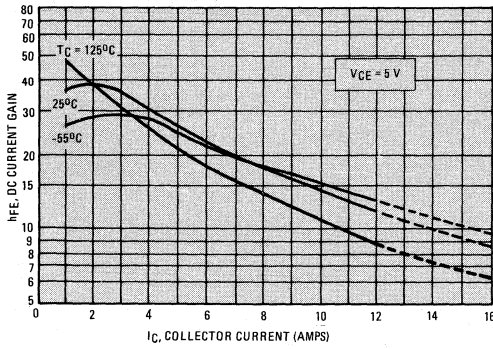

SATURATION VOLTAGES

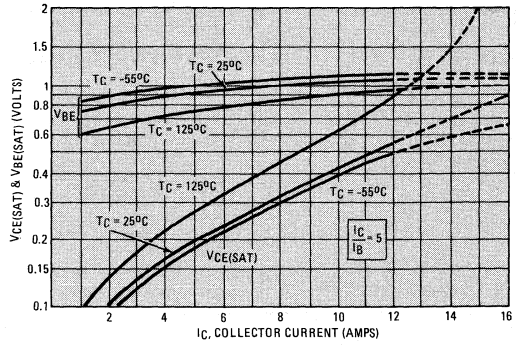

FORWARD BIASED SAFE OPERATING AREA

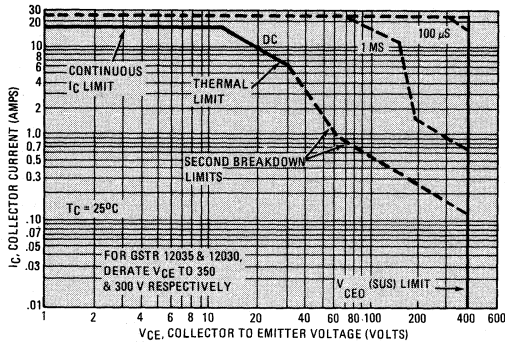

TURN-OFF SAFE OPERATING AREA

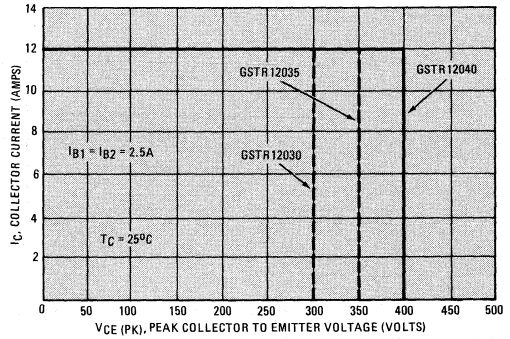

$E_{S/B}$ CURVE

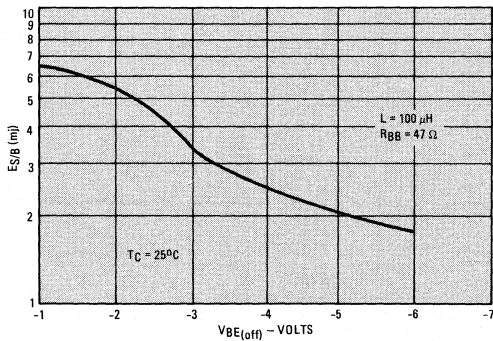

PACKAGE OUTLINE TO-3

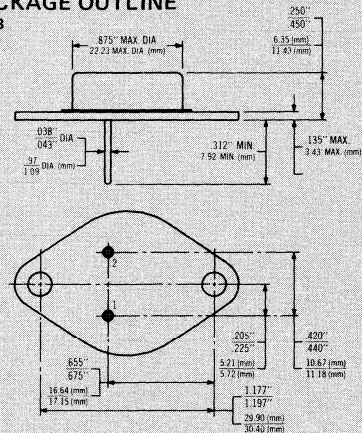

GENERAL SEMICONDUCTOR INDUSTRIES, INC.

2001 West Tenth Place, Tempe, Arizona 85281 • 602.968.3101 • TWX910-950.1942
Mailing Address: P. O. Box 3078



**GENERAL
SEMICONDUCTOR
INDUSTRIES, INC.**

C²R

**XDAR10025
XDAR10030
XDAR10035**

NPN SWITCHING POWER TRANSISTORS

This unique series utilizes General Semiconductor Industries' C²R process (patent applied for) which describes a manufacturing technology that provides surface stabilization for high voltage operation and enhances long term reliability.

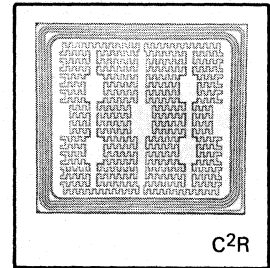
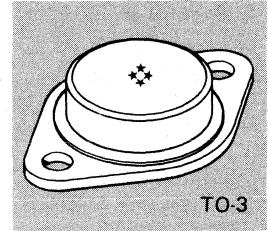

MAXIMUM RATINGS

RATINGS	SYMBOL	XDAR10025	XDAR10030	XDAR10035	UNIT
Collector-Base Voltage	V_{CBO}	300	350	400	Vdc
Collector-Emitter Voltage	V_{CEO}	250	300	350	Vdc
Emitter-Base Voltage	V_{EBO}	8.0			Vdc
Collector Current - Continuous	I_C	15			Acd
Base Current - Continuous	I_B	5.0			Acd
Total Power Dissipation @ $T_C=100^\circ\text{C}$	P_D	75			Watt
Thermal Resistance (Junction to Case)	θ_{J-C}	1.0			$^\circ\text{C/W}$
Junction Temperature	T_J	-65 to +175			$^\circ\text{C}$
Storage Temperature	T_{stg}	-65 to +200			$^\circ\text{C}$

4

**NPN SWITCHING
TRANSISTORS**

ELECTRICAL CHARACTERISTICS (T = 25°C unless otherwise specified)

CHARACTERISTIC	SYMBOL	MIN	TYP	MAX	UNIT
----------------	--------	-----	-----	-----	------

OFF CHARACTERISTICS

Collector-Base Voltage ($I_C=10mA$)	XDAR10025 XDAR10030 XDAR10035	BV_{CBO}	300 350 400		Vdc
Collector-Emitter Voltage ($I_C=50mA$)	XDAR10025 XDAR10030 XDAR10035	BV_{CEO}	250 300 350		Vdc
Emitter-Base Voltage ($I_E=1.0mA$)		BV_{EBO}	8.0		Vdc
Collector Cutoff Current ($V_{CB}=80\%$ Rated V_{CB})	XDAR10025 XDAR10030 XDAR10035	I_{CBO}		500 500 500	μA
Emitter Cutoff Current ($V_{EB}=5.0V$)		I_{EBO}		100	μA
Collector Cutoff Current ($V_{CE}=80\%$ Rated V_{CE})	XDAR10025 XDAR10030 XDAR10035	I_{CEO}		1.0 1.0 1.0	μA

ON CHARACTERISTICS

DC Current Gain ($V_{CE}=5.0V$, $I_C=10A$)	XDAR10025 XDAR10030 XDAR10035	h_{FE}^*	25 25 20		
DC Current Gain ($V_{CE}=5.0V$, $I_C=3.0A$)		h_{FE}^*	65		
Collector Saturation Voltage ($I_C=10A$, $I_B=2.0A$)		$V_{CE(sat)}^*$		0.8	Vdc
Base Saturation Voltage ($I_C=10A$, $I_B=2.0A$)		$V_{BE(sat)}^*$		1.3	Vdc

DYNAMIC CHARACTERISTICS

Small Signal Current Gain ($V_{CE}=10V$, $I_C=1.0A$, $f=10MHz$)		$ h_{fe} $	25		
Collector Base Capacitance ($V_{CB}=10V$, $I_C=0$, $f=1MHz$)		C_{ob}		350	pF
Turn-on Time ($V_{CC}=100V$, $I_C=10A$, $I_{B1}=1.0A$, $I_{B2}=1.0A$)		t_{on}		0.2	μs
Storage Time ($V_{CC}=100V$, $I_C=10A$, $I_{B1}=1.0A$, $I_{B2}=1.0A$)		t_s		1.5	μs
Fall Time ($V_{CC}=100V$, $I_C=10A$, $I_{B1}=1.0A$, $I_{B2}=1.0A$)		t_f		0.5	μs

*Pulse measurement conditions: Length = 300 μs , Duty Cycle $\leq 2\%$.



**GENERAL
SEMICONDUCTOR
INDUSTRIES, INC.**

**NPN
XGS7001
XGS7002**

SILICON NPN TRANSISTORS

These double diffused, epitaxial collector devices are oxide passivated. They are designed for use in switching and many amplifier applications. The latest technologies are used to provide optimum performance and the highest degree of reliability.

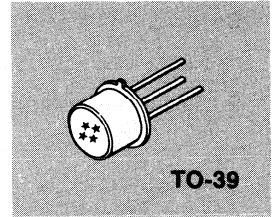

4

**NPN SWITCHING
TRANSISTORS**

ABSOLUTE MAXIMUM RATINGS

RATINGS	SYMBOL	XGS7001	XGS7002	UNIT
Collector-Base Voltage	V_{CBO}	50	70	Vdc
Collector-Emitter Voltage	V_{CEO}	30	60	Vdc
Emitter-Base Voltage	V_{EBO}	5.0	5.0	Vdc
Collector Current — Continuous	I_C	3.0	3.0	Adc
Base Current — Continuous	I_B	1.0	1.0	Adc
Total Power Dissipation @ $T_C=100^\circ\text{C}$	P_D	5.0	5.0	Watt
Thermal Resistance (Junction to Case)	θ_{JC}	35	35	$^\circ\text{C/W}$
Junction Temperature	T_J	-65 to +200	-65 to +200	$^\circ\text{C}$
Storage Temperature	T_{stg}	-65 to +200	-65 to +200	$^\circ\text{C}$

ELECTRICAL CHARACTERISTICS (T = 25°C unless otherwise specified)

CHARACTERISTIC		SYMBOL	MIN	TYP	MAX	UNIT
OFF CHARACTERISTICS						
Collector-Base Voltage ($I_C = 100 \mu A$)	XGS7001 XGS7002	BV_{CBO}	50 70			Vdc
Collector-Emitter Voltage ($I_C = 10mA$)	XGS7001 XGS7002	BV_{CEO}	30 60			Vdc
Emitter-Base Voltage ($I_E = 10 \mu A$)		BV_{EBO}	5.0			Vdc
Collector Cutoff Current ($V_{CB} = 30V$ for 7001; $40V$ for 7002)		I_{CBO}			10	μA
ON CHARACTERISTICS						
DC Current Gain ($V_{CE} = 2.0V$, $I_C = 2.0A$)	XGS7001 XGS7002	h_{FE}^*	20 15			
Collector Saturation Voltage ($I_C = 1.0A$, $I_B = 0.1A$)		$V_{CE(sat)}^*$			1.0	Vdc
Base Saturation Voltage ($I_C = 1.0A$, $I_B = 0.1A$)		$V_{BE(sat)}^*$			1.5	Vdc
DYNAMIC CHARACTERISTICS						
Small Signal Current Gain ($V_{CE} = 5.0V$, $I_C = 0.1A$, $f = 20MHz$)		$ h_{fe} $	6.0			
Collector Base Capacitance ($V_{CB} = 10V$, $I_C =$, $f = 1.0MHz$)		C_{ob}			40	pF
Turn-on Time ($V_{CC} = 30V$, $I_C = 1.5A$, $I_{B1} = 0.15A$, $I_{B2} = 0.15A$)		t_{on}			40	NS
Turn-off Time ($V_{CC} = 30V$, $I_C = 1.5A$, $I_{B1} = 0.15A$, $I_{B2} = 0.15A$)		t_{off}			100	NS

*Pulse Measurement Conditions: Length = $300\mu s$, Duty Cycle $\leq 2\%$



**GENERAL
SEMICONDUCTOR
INDUSTRIES, INC.**

C²R

**XGSA1030
XGSA1035
XGSA1040**

NPN SWITCHING POWER TRANSISTORS

This unique series utilizes General Semiconductor Industries' C²R process (patent applied for) which describes a manufacturing technology that provides surface stabilization for high voltage operation and enhances long term reliability.

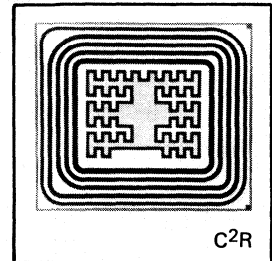
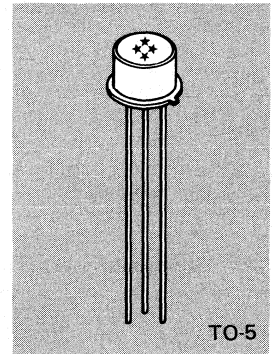

4

**NPN SWITCHING
TRANSISTORS**

MAXIMUM RATINGS

RATINGS	SYMBOL	XGSA1030	XGSA1035	XGSA1040	UNIT
Collector-Base Voltage	V_{CBO}	350	400	450	Vdc
Collector-Emitter Voltage	V_{CEO}	300	350	400	Vdc
Emitter-Base Voltage	V_{EBO}	7.0			Vdc
Collector Current - Continuous	I_C	2.0			Adc
Base Current - Continuous	I_B	1.0			Adc
Total Power Dissipation @ $T_C=100^\circ\text{C}$	P_D	7.5			Watt
Thermal Resistance (Junction to Case)	θ_{J-C}	10			$^\circ\text{C/W}$
Junction Temperature	T_J	-65 to +175			$^\circ\text{C}$
Storage Temperature	T_{stg}	-65 to +200			$^\circ\text{C}$

ELECTRICAL CHARACTERISTICS (T = 25°C unless otherwise specified)

CHARACTERISTIC		SYMBOL	MIN	TYP	MAX	UNIT
OFF CHARACTERISTICS						
Collector-Base Voltage ($I_C=0.5mA$)	XGSA1030 XGSA1035 XGSA1040	BV_{CBO}	350 400 450			Vdc
Collector-Emitter Voltage ($I_C=10mA$)	XGSA1030 XGSA1035 XGSA1040	BV_{CEO}	300 350 400			Vdc
Emitter-Base Voltage ($I_E=0.1mA$)		BV_{EBO}	7.0			Vdc
Collector Cutoff Current ($V_{CB}=280V$)	XGSA1030	I_{CBO}			10	μA
($V_{CB}=320V$)	XGSA1035				10	
($V_{CB}=360V$)	XGSA1040				10	
Emitter Cutoff Current ($V_{EB}=5.0V$)		I_{EBO}			10	μA
Collector Cutoff Current ($V_{CE}=240V$)	XGSA1030	I_{CEO}			50	μA
($V_{CE}=280V$)	XGSA1035				50	
($V_{CE}=320V$)	XGSA1040				50	

ON CHARACTERISTICS

DC Current Gain ($V_{CE}=5.0V$, $I_C=1.0A$)		h_{FE}^*	10			
Collector Saturation Voltage ($I_C=1.0A$, $I_B=0.2A$)		$V_{CE(sat)}^*$			0.4	Vdc
Base Saturation Voltage ($I_C=1.0A$, $I_B=0.2A$)		$V_{BE(sat)}^*$			1.2	Vdc

DYNAMIC CHARACTERISTICS

Small Signal Current Gain ($V_{CE}=10V$, $I_C=.25A$, $f=10MHz$)		$ h_{fe} $	3			
Collector Base Capacitance ($V_{CB}=10V$, $f=1MHz$)		C_{ob}			50	pF
Delay Time ($V_{CC}=200V$, $I_C=1.0A$, $I_{B1}=0.2A$, $I_{B2}=0.2A$)		t_d			0.04	μs
Rise Time ($V_{CC}=200V$, $I_C=1.0A$, $I_{B1}=0.2A$, $I_{B2}=0.2A$)		t_r			0.20	μs
Storage Time ($V_{CC}=200V$, $I_C=1.0A$, $I_{B1}=0.2A$, $I_{B2}=0.2A$)		t_s			1.5	μs
Fall Time ($V_{CC}=200V$, $I_C=1.0A$, $I_{B1}=0.2A$, $I_{B2}=0.2A$)		t_f			0.30	μs

*Pulse measurement conditions: Length = 300 μs , Duty Cycle $\leq 2\%$.



**GENERAL
SEMICONDUCTOR
INDUSTRIES, INC.**

C²R

XGSA1530
XGSA1535
XGSA1540

NPN SWITCHING POWER TRANSISTORS

This unique series utilizes General Semiconductor Industries' C²R process (patent applied for) which describes a manufacturing technology that provides surface stabilization for high voltage operation and enhances long term reliability.

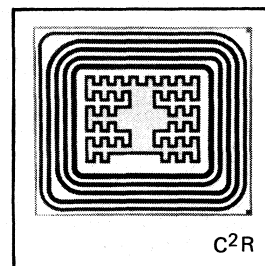
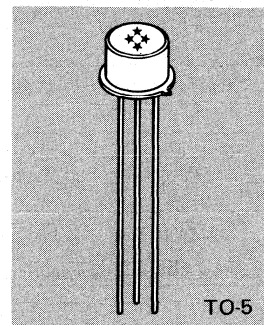

4

NPN SWITCHING
TRANSISTORS

MAXIMUM RATINGS

RATINGS	SYMBOL	XGSA1530	XGSA1535	XGSA1540	UNIT
Collector-Base Voltage	V_{CBO}	350	400	450	Vdc
Collector-Emitter Voltage	V_{CEO}	300	350	400	Vdc
Emitter-Base Voltage	V_{EBO}	7.0			Vdc
Collector Current - Continuous	I_C	2			Adc
Collector Current - Peak	I_C	5			Adc
Base Current - Continuous	I_B	1			Adc
Total Power Dissipation @ $T_C=100^\circ\text{C}$	P_D	7.5			Watt
Total Power Dissipation @ $T_A=25^\circ\text{C}$	P_D	1.0			Watt
Thermal Resistance (Junction to Case)	θ_{J-C}	10			$^\circ\text{C}/\text{W}$
Thermal Resistance (Junction to Ambient)	θ_{J-A}	150			$^\circ\text{C}/\text{W}$
Junction Temperature	T_J	-65 to +175			$^\circ\text{C}$
Storage Temperature	T_{stg}	-65 to +200			$^\circ\text{C}$

ELECTRICAL CHARACTERISTICS (T = 25°C unless otherwise specified)

CHARACTERISTIC	SYMBOL	MIN	TYP	MAX	UNIT
----------------	--------	-----	-----	-----	------

OFF CHARACTERISTICS

Collector-Base Voltage ($I_C=0.5mA$)	XGSA1530 XGSA1535 XGSA1540	BV_{CBO}	350 400 450		Vdc
Collector-Emitter Voltage ($I_C=10mA$)	XGSA1530 XGSA1535 XGSA1540	BV_{CEO}	300 350 400		Vdc
Emitter-Base Voltage ($I_E=.1mA$)		BV_{EBO}	7.0		Vdc
Collector Cutoff Current ($V_{CB}=80\% V_{CB}$ Rated)	XGSA1530 XGSA1535 XGSA1540	I_{CBO}		10 10 10	μA
Emitter Cutoff Current ($V_{EB}=5.0V$)		I_{EBO}		10	μA
Collector Cutoff Current ($V_{CE}=80\% V_{CE}$ Rated)	XGSA1530 XGSA1535 XGSA1540	I_{CEO}		50 50 50	μA

ON CHARACTERISTICS

DC Current Gain ($V_{CE}=2V, I_C=1A$)		h_{FE}^*	10		
DC Current Gain ($V_{CE}=5V, I_C=1.5A$)		h_{FE}^*	10		
Collector Saturation Voltage ($I_C=1A, I_B=0.2A$)		$V_{CE(sat)}^*$		0.3	Vdc
Collector Saturation Voltage ($I_C=1.5A, I_B=0.3A$)		$V_{CE(sat)}^*$		0.4	Vdc
Base Saturation Voltage ($I_C=1.5A, I_B=0.3A$)		$V_{BE(sat)}^*$		1.2	Vdc

DYNAMIC CHARACTERISTICS

Small Signal Current Gain ($V_{CE}=10V, I_C=.25A, f=10MHz$)		$ h_{fe} $	3		
Collector Base Capacitance ($V_{CB}=10V, f=1MHz$)		C_{ob}		50	pF
Delay Time ($V_{CC}=200V, I_C=1.5A, I_{B1}=0.75A/0.30A, I_{B2}=0.5A$)		t_d		0.1	μs
Rise Time ($V_{CC}=250V, I_C=1.5A, I_{B1}=0.3A, I_{B2}=0.3A$)		t_r		0.2	μs
Storage Time ($V_{CC}=250V, I_C=1.5A, I_{B1}=0.3A, I_{B2}=0.3A$)		t_s		1.0	μs
Fall Time ($V_{CC}=250V, I_C=1.5A, I_{B1}=0.3A, I_{B2}=0.3A$)		t_f		.25	μs

*Pulse measurement conditions: Length = 300 μs , Duty Cycle $\leq 2\%$.



**GENERAL
SEMICONDUCTOR
INDUSTRIES, INC.**

C²R[®]

**XGSA3030
XGSA3035
XGSA3040**

NPN SWITCHING POWER TRANSISTORS

This unique series utilizes General Semiconductor Industries' C²R process (patent applied for) which describes a manufacturing technology that provides surface stabilization for high voltage operation and enhances long term reliability.

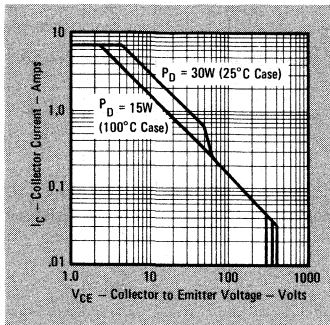

DC Forward Biased Safe Operating Area

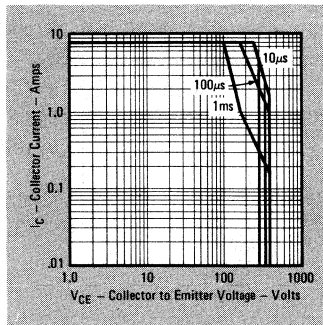

Pulsed Forward Biased Safe Operating Area

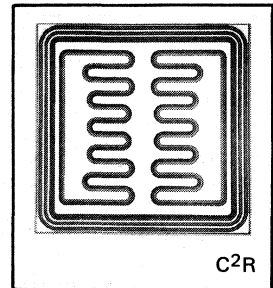
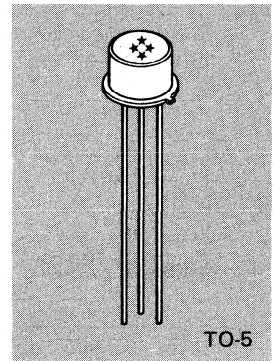

4

**NPN SWITCHING
TRANSISTORS**

MAXIMUM RATINGS

RATINGS	SYMBOL	XGSA3030	XGSA3035	XGSA3040	UNIT
Collector-Base Voltage	V_{CBO}	350	400	450	Vdc
Collector-Emitter Voltage	V_{CEO}	300	350	400	Vdc
Emitter-Base Voltage	V_{EBO}	7.0			Vdc
Collector Current - Continuous	I_C	5.0			Adc
Base Current - Continuous	I_B	1.0			Adc
Total Power Dissipation @ $T_C=100^\circ\text{C}$	P_D	10			Watt
Thermal Resistance (Junction to Case)	θ_{J-C}	7.5			$^\circ\text{C/W}$
Junction Temperature	T_J	-65 to +175			$^\circ\text{C}$
Storage Temperature	T_{stg}	-65 to +200			$^\circ\text{C}$

ELECTRICAL CHARACTERISTICS (T = 25°C unless otherwise specified)

CHARACTERISTIC		SYMBOL	MIN	TYP	MAX	UNIT
Collector-Base Voltage ($I_C=1.0mA$)	XGSA3030 XGSA3035 XGSA3040	V_{CBO}	350 400 450			Vdc
Collector-Emitter Voltage ($I_C=50mA$)	XGSA3030 XGSA3035 XGSA3040	V_{CEO}	300 350 400			Vdc
Emitter-Base Voltage ($I_E=1.0mA$)		V_{EBO}	7.0			Vdc
Collector Cutoff Current ($V_{CB}=80\%$ Rated V_{CB})	XGSA3030 XGSA3035 XGSA3040	I_{CBO}			250 250 250	μA
Emitter Cutoff Current ($V_{EB}=5.0V$)		I_{EBO}			50	μA
Collector Cutoff Current ($V_{CE}=80\%$ Rated V_{CE})	XGSA3030 XGSA3035 XGSA3040	I_{CEO}			500 500 500	μA

ON CHARACTERISTICS

DC Current Gain ($V_{CE}=5.0V$, $I_C=3.0A$)		h_{FE}^*	10			
Collector Saturation Voltage ($I_C=3.0A$, $I_B=0.6A$)		$V_{CE(sat)}^*$			1.0	Vdc
Base Saturation Voltage ($I_C=3.0A$, $I_B=0.6A$)		$V_{BE(sat)}^*$			1.5	Vdc

DYNAMIC CHARACTERISTICS

Small Signal Current Gain ($V_{CE}=10V$, $I_C=0.5A$, $f=10MHz$)		$ h_{fe} $	2.5			
Collector Base Capacitance ($V_{CB}=10V$, $f=1MHz$)		C_{ob}			250	pF
Turn-on Time ($V_{CC}=250V$, $I_C=3.0A$, $I_{B1}=0.6A$, $I_{B2}=0.6A$)		t_{on}			0.2	μs
Storage Time ($V_{CC}=250V$, $I_C=3.0A$, $I_{B1}=0.6A$, $I_{B2}=0.6A$)		t_s			2.0	μs
Fall Time ($V_{CC}=250V$, $I_C=3.0A$, $I_{B1}=0.6A$, $I_{B2}=0.6A$)		t_f			0.35	μs

*Pulse measurement conditions: Length = 300 μs , Duty Cycle \leq 2%.



**GENERAL
SEMICONDUCTOR
INDUSTRIES, INC.**

C²R
XGSA5030
XGSA5035
XGSA5040

NPN SWITCHING POWER TRANSISTORS

This unique series utilizes General Semiconductor Industries' C²R process (patent applied for) which describes a manufacturing technology that provides surface stabilization for high voltage operation and enhances long term reliability.

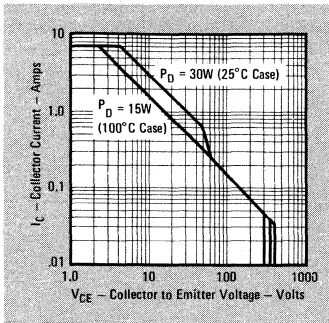

DC Forward Biased Safe Operating Area

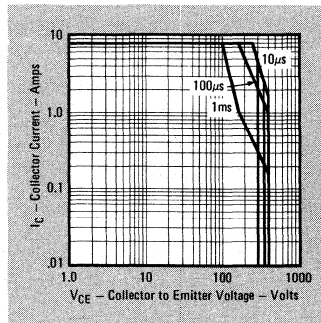

Pulsed Forward Biased Safe Operating Area

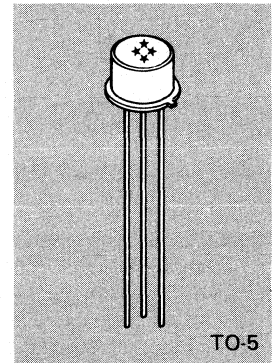

TO-5

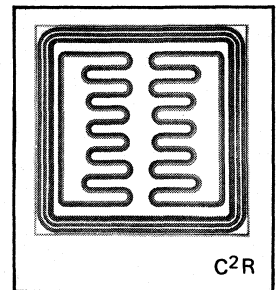

C²R

4

NPN SWITCHING
TRANSISTORS

MAXIMUM RATINGS

RATINGS	SYMBOL	XGSA5030	XGSA5035	XGSA5040	UNIT
Collector-Base Voltage	V_{CBO}	350	400	450	Vdc
Collector-Emitter Voltage	V_{CEO}	300	350	400	Vdc
Emitter-Base Voltage	V_{EBO}	7.0			Vdc
Collector Current - Continuous	I_C	7.0			Adc
Base Current - Continuous	I_B	2.0			Adc
Total Power Dissipation @ $T_C=100^\circ C$	P_D	10			Watt
Thermal Resistance (Junction to Case)	θ_{J-C}	7.5			$^\circ C/W$
Junction Temperature	T_J	-65 to +175			$^\circ C$
Storage Temperature	T_{stg}	-65 to +200			$^\circ C$

ELECTRICAL CHARACTERISTICS (T = 25°C unless otherwise specified)

CHARACTERISTIC	SYMBOL	MIN	TYP	MAX	UNIT
----------------	--------	-----	-----	-----	------

OFF CHARACTERISTICS

Collector-Base Voltage ($I_C=1.0mA$)	XGSA5030 XGSA5035 XGSA5040	BV_{CBO}	350 400 450		Vdc
Collector-Emitter Voltage ($I_C=50mA$)	XGSA5030 XGSA5035 XGSA5040	BV_{CEO}	300 350 400		Vdc
Emitter-Base Voltage ($I_E=1.0mA$)		BV_{EBO}	7.0		Vdc
Collector Cutoff Current ($V_{CB}=80\%$ Rated V_{CB})	XGSA5030 XGSA5035 XGSA5040	I_{CBO}		250 250 250	μA
Emitter Cutoff Current ($V_{EB}=5.0V$)		I_{EBO}		50	μA
Collector Cutoff Current ($V_{CE}=80\%$ Rated V_{CE})	XGSA5030 XGSA5035 XGSA5040	I_{CEO}		500 500 500	μA

ON CHARACTERISTICS

DC Current Gain ($V_{CE}=5.0V$, $I_C=5.0A$)	h_{FE}^*	10			
Collector Saturation Voltage ($I_C=5.0A$, $I_B=1.0A$)	$V_{CE(sat)}^*$			0.8	Vdc
Base Saturation Voltage ($I_C=5.0A$, $I_B=1.0A$)	$V_{BE(sat)}^*$			1.3	Vdc

DYNAMIC CHARACTERISTICS

Small Signal Current Gain ($V_{CE}=10V$, $I_C=0.5A$, $f=10MHz$)	$ h_{fe} $	2.5			
Collector Base Capacitance ($V_{CB}=10V$, $f=1MHz$)	C_{ob}			250	pF
Turn-on Time ($V_{CC}=250V$, $I_C=5.0A$, $I_{B1}=1.0A$, $I_{B2}=1.0A$)	t_{on}			0.5	μs
Storage Time ($V_{CC}=250V$, $I_C=5.0A$, $I_{B1}=1.0A$, $I_{B2}=1.0A$)	t_s			1.25	μs
Fall Time ($V_{CC}=250V$, $I_C=5.0A$, $I_{B1}=1.0A$, $I_{B2}=1.0A$)	t_f			0.4	μs

*Pulse measurement conditions: Length = 300 μs , Duty Cycle $\leq 2\%$.



**GENERAL
SEMICONDUCTOR
INDUSTRIES, INC.**

C²R

**XGSQ1030
XGSQ1035
XGSQ1040**

NPN SWITCHING POWER TRANSISTORS

This unique series utilizes General Semiconductor Industries' C²R process (patent applied for) which describes a manufacturing technology that provides surface stabilization for high voltage operation and enhances long term reliability.

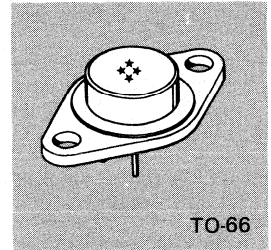

TO-66

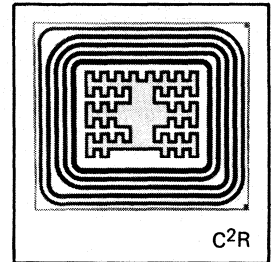

C²R

MAXIMUM RATINGS

RATINGS	SYMBOL	XGSQ1030	XGSQ1035	XGSQ1040	UNIT
Collector-Base Voltage	V_{CBO}	350	400	450	Vdc
Collector-Emitter Voltage	V_{CEO}	300	350	400	Vdc
Emitter-Base Voltage	V_{EBO}	7.0			Vdc
Collector Current - Continuous	I_C	2.0			Adc
Base Current - Continuous	I_B	1.0			Adc
Total Power Dissipation @ $T_C=100^\circ\text{C}$	P_D	10			Watt
Thermal Resistance (Junction to Case)	θ_{J-C}	7.5			$^\circ\text{C}/\text{W}$
Junction Temperature	T_J	-65 to +175			$^\circ\text{C}$
Storage Temperature	T_{stg}	-65 to +200			$^\circ\text{C}$

4
NPN SWITCHING
TRANSISTORS

ELECTRICAL CHARACTERISTICS (T = 25°C unless otherwise specified)

CHARACTERISTIC	SYMBOL	MIN	TYP	MAX	UNIT
----------------	--------	-----	-----	-----	------

OFF CHARACTERISTICS

Collector-Base Voltage ($I_C=0.5mA$)	XGSQ1030 XGSQ1035 XGSQ1040	BV_{CBO}	350 400 450		Vdc
Collector-Emitter Voltage ($I_C=10mA$)	XGSQ1030 XGSQ1035 XGSQ1040	BV_{CEO}	300 350 400		Vdc
Emitter-Base Voltage ($I_E=0.1mA$)		BV_{EBO}	7.0		Vdc
Collector Cutoff Current ($V_{CB}=280V$) ($V_{CB}=320V$) ($V_{CB}=360V$)	XGSQ1030 XGSQ1035 XGSQ1040	I_{CBO}		10 10 10	μA
Emitter Cutoff Current ($V_{EB}=5.0V$)		I_{EBO}		10	μA
Collector Cutoff Current ($V_{CE}=240V$) ($V_{CE}=280V$) ($V_{CE}=320V$)	XGSQ1030 XGSQ1035 XGSQ1040	I_{CEO}		50 50 50	μA

ON CHARACTERISTICS

DC Current Gain ($V_{CE}=5V, I_C=1.0A$)	h_{FE}^*	10			
Collector Saturation Voltage ($I_C=1.0A, I_B=0.2A$)	$V_{CE(sat)}^*$			0.4	Vdc
Base Saturation Voltage ($I_C=1.0A, I_B=0.2A$)	$V_{BE(sat)}^*$			1.2	Vdc

DYNAMIC CHARACTERISTICS

Small Signal Current Gain ($V_{CE}=10V, I_C=.25A, f=10MHz$)	$ h_{fe} $	3			
Collector Base Capacitance ($V_{CB}=10V, f=1MHz$)	C_{ob}			50	pF
Delay Time ($V_{CC}=200V, I_C=1.0A, I_{B1}=0.2A, I_{B2}=0.2A$)	t_d			0.04	μs
Rise Time ($V_{CC}=200V, I_C=1.0A, I_{B1}=0.2A, I_{B2}=0.2A$)	t_r			0.20	μs
Storage Time ($V_{CC}=200V, I_C=1.0A, I_{B1}=0.2A, I_{B2}=0.2A$)	t_s			1.5	μs
Fall Time ($V_{CC}=200V, I_C=1.0A, I_{B1}=0.2A, I_{B2}=0.2A$)	t_f			0.30	μs

*Pulse measurement conditions: Length = 300 μs , Duty Cycle \leq 2%.



**GENERAL
SEMICONDUCTOR
INDUSTRIES, INC.**

C²R

**XGSQ1530
XGSQ1535
XGSQ1540**

NPN SWITCHING POWER TRANSISTORS

This unique series utilizes General Semiconductor Industries' C²R process (patent applied for) which describes a manufacturing technology that provides surface stabilization for high voltage operation and enhances long term reliability.

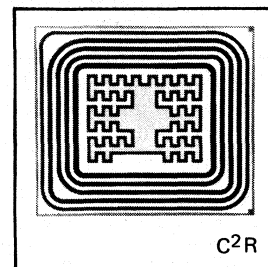
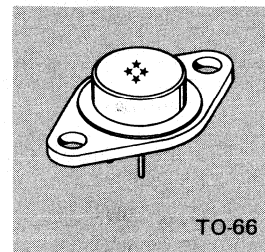

MAXIMUM RATINGS

RATINGS	SYMBOL	XGSQ1530	XGSQ1535	XGSQ1540	UNIT
Collector-Base Voltage	V_{CBO}	350	400	450	Vdc
Collector-Emitter Voltage	V_{CEO}	300	350	400	Vdc
Emitter-Base Voltage	V_{EBO}		7.0		Vdc
Collector Current - Continuous	I_C		2.0		Adc
Base Current - Continuous	I_B		1.0		Adc
Total Power Dissipation @ $T_C=100^\circ\text{C}$	P_D		10		Watt
Thermal Resistance (Junction to Case)	θ_{J-C}		7.5		$^\circ\text{C}/\text{W}$
Junction Temperature	T_J		-65 to +175		$^\circ\text{C}$
Storage Temperature	T_{stg}		-65 to +200		$^\circ\text{C}$

4

NPN SWITCHING
TRANSISTORS

ELECTRICAL CHARACTERISTICS (T = 25°C unless otherwise specified)

CHARACTERISTIC	SYMBOL	MIN	TYP	MAX	UNIT
----------------	--------	-----	-----	-----	------

OFF CHARACTERISTICS

Collector-Base Voltage ($I_C=0.5mA$)	XGSQ1530 XGSQ1535 XGSQ1540	BV_{CBO}	350 400 450		Vdc
Collector-Emitter Voltage ($I_C=10mA$)	XGSQ1530 XGSQ1535 XGSQ1540	BV_{CEO}	300 350 400		Vdc
Emitter-Base Voltage ($I_E=0.1mA$)		BV_{EBO}	7.0		Vdc
Collector Cutoff Current ($V_{CB}=280V$) ($V_{CB}=320V$) ($V_{CB}=360V$)	XGSQ1530 XGSQ1535 XGSQ1540	I_{CBO}		10 10 10	μA
Emitter Cutoff Current ($V_{EB}=5.0V$)		I_{EBO}		10	μA
Collector Cutoff Current ($V_{CE}=240V$) ($V_{CE}=280V$) ($V_{CE}=320V$)	XGSQ1530 XGSQ1535 XGSQ1540	I_{CEO}		50 50 50	μA

ON CHARACTERISTICS

DC Current Gain ($V_{CE}=1V, I_C=1A$)	h_{FE}^*	10			
DC Current Gain ($V_{CE}=5V, I_C=1.5A$)	h_{FE}^*	10			
Collector Saturation Voltage ($I_C=1A, I_B=0.2A$)	$V_{CE(sat)}^*$			0.3	Vdc
Collector Saturation Voltage ($I_C=1.5A, I_B=0.3A$)	$V_{CE(sat)}^*$			0.4	Vdc
Base Saturation Voltage ($I_C=1.5A, I_B=0.3A$)	$V_{BE(sat)}^*$			1.2	Vdc

DYNAMIC CHARACTERISTICS

Small Signal Current Gain ($V_{CE}=10V, I_C=0.25A, f=10MHz$)	$ h_{fe} $	3			
Collector Base Capacitance ($V_{CB}=10V, f=1MHz$)	C_{ob}			50	pF
Delay Time ($V_{CC}=2.50V, I_C=1.5A, I_{B1}=0.3A, I_{B2}=0.3A$)	t_d			0.1	μs
Rise Time ($V_{CC}=2.50V, I_C=1.5A, I_{B1}=0.3A, I_{B2}=0.3A$)	t_r			0.2	μs
Storage Time ($V_{CC}=2.50V, I_C=1.5A, I_{B1}=0.3A, I_{B2}=0.3A$)	t_s			1.0	μs
Fall Time ($V_{CC}=2.50V, I_C=1.5A, I_{B1}=0.3A, I_{B2}=0.3A$)	t_f			0.25	μs

*Pulse measurement conditions: Length = 300 μs , Duty Cycle \leq 2%.



**GENERAL
SEMICONDUCTOR
INDUSTRIES, INC.**

**C²R
XGSQ3030
XGSQ3035
XGSQ3040**

NPN SWITCHING POWER TRANSISTORS

This unique series utilizes General Semiconductor Industries' C²R process (patent applied for) which describes a manufacturing technology that provides surface stabilization for high voltage operation and enhances long term reliability.

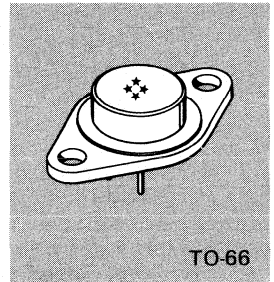

TO-66

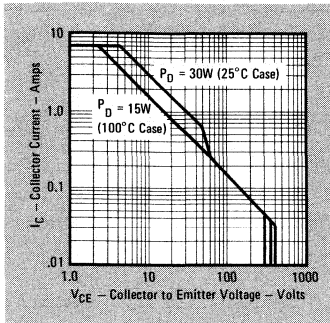

DC Forward Biased Safe Operating Area

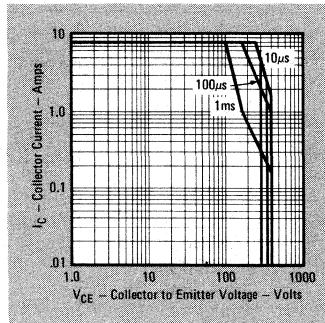

Pulsed Forward Biased Safe Operating Area

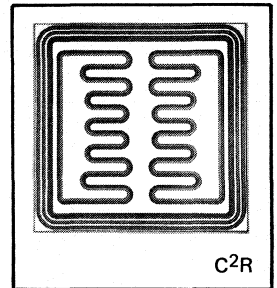

C²R

MAXIMUM RATINGS

RATINGS	SYMBOL	XGSQ3030	XGSQ3035	XGSQ3040	UNIT
Collector-Base Voltage	V_{CBO}	350	400	450	Vdc
Collector-Emitter Voltage	V_{CEO}	300	350	400	Vdc
Emitter-Base Voltage	V_{EBO}	7.0			Vdc
Collector Current - Continuous	I_C	5.0			Adc
Base Current - Continuous	I_B	1.0			Adc
Total Power Dissipation @ $T_C=100^\circ\text{C}$	P_D	15			Watt
Thermal Resistance (Junction to Case)	θ_{J-C}	5.0			$^\circ\text{C/W}$
Junction Temperature	T_J	-65 to +175			$^\circ\text{C}$
Storage Temperature	T_{stg}	-65 to +200			$^\circ\text{C}$

4

NPN SWITCHING
TRANSISTORS

ELECTRICAL CHARACTERISTICS (T = 25°C unless otherwise specified)

CHARACTERISTIC	SYMBOL	MIN	TYP	MAX	UNIT
----------------	--------	-----	-----	-----	------

OFF CHARACTERISTICS

Collector-Base Voltage ($I_C=1.0mA$)	XGSQ3030 XGSQ3035 XGSQ3040	BV_{CBO}	350 400 450		Vdc
Collector-Emitter Voltage ($I_C=50mA$)	XGSQ3030 XGSQ3035 XGSQ3040	BV_{CEO}	300 350 400		Vdc
Emitter-Base Voltage ($I_E=1.0mA$)		BV_{EBO}	7.0		Vdc
Collector Cutoff Current ($V_{CB}=80\%$ Rated V_{CB})	XGSQ3030 XGSQ3035 XGSQ3040	I_{CBO}		250 250 250	μA
Emitter Cutoff Current ($V_{EB}=5.0V$)		I_{EBO}		50	μA
Collector Cutoff Current ($V_{CE}=80\%$ Rated V_{CE})	XGSQ3030 XGSQ3035 XGSQ3040	I_{CEO}		500 500 500	μA

ON CHARACTERISTICS

DC Current Gain ($V_{CE}=5.0V$, $I_C=3.0A$)	h_{FE}^*	10			
Collector Saturation Voltage ($I_C=3.0A$, $I_B=0.6A$)	$V_{CE(sat)}^*$			0.8	Vdc
Base Saturation Voltage ($I_C=3.0A$, $I_B=0.6A$)	$V_{BE(sat)}^*$			1.3	Vdc

DYNAMIC CHARACTERISTICS

Small Signal Current Gain ($V_{CE}=10V$, $I_C=0.5A$, $f=10MHz$)	$ h_{fe} $	2.5			
Collector Base Capacitance ($V_{CB}=10V$, $f=1MHz$)	C_{ob}			250	pF
Turn-on Time ($V_{CC}=250V$, $I_C=3.0A$, $I_{B1}=0.6A$, $I_{B2}=0.6A$)	t_{on}			0.2	μs
Storage Time ($V_{CC}=250V$, $I_C=3.0A$, $I_{B1}=0.6A$, $I_{B2}=0.6A$)	t_s			2.0	μs
Fall Time ($V_{CC}=250V$, $I_C=3.0A$, $I_{B1}=0.6A$, $I_{B2}=0.6A$)	t_f			0.35	μs

*Pulse measurement conditions: Length = 300 μs , Duty Cycle $\leq 2\%$.



**GENERAL
SEMICONDUCTOR
INDUSTRIES, INC.**

C²R

**XGSQ5030
XGSQ5035
XGSQ5040**

NPN SWITCHING POWER TRANSISTORS

This unique series utilizes General Semiconductor Industries' C²R process (patent applied for) which describes a manufacturing technology that provides surface stabilization for high voltage operation and enhances long term reliability.

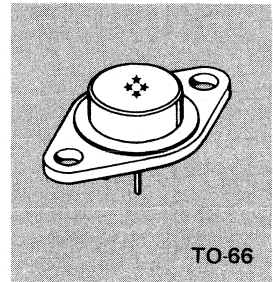

TO-66

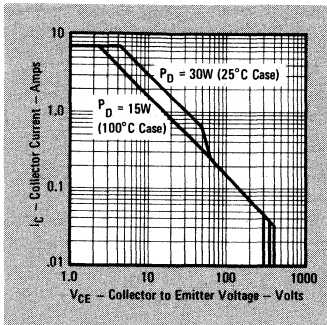

DC Forward Biased Safe Operating Area

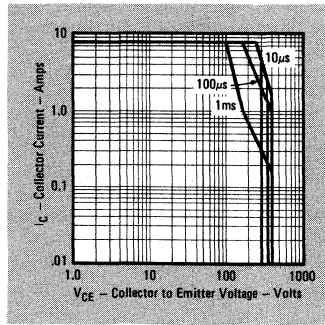

Pulsed Forward Biased Safe Operating Area

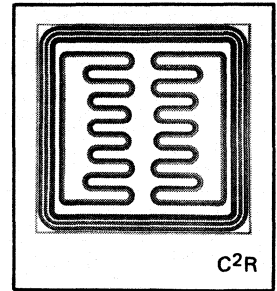

C²R

MAXIMUM RATINGS

RATINGS	SYMBOL	XGSQ5030	XGSQ5035	XGSQ5040	UNIT
Collector-Base Voltage	V_{CBO}	350	400	450	Vdc
Collector-Emitter Voltage	V_{CEO}	300	350	400	Vdc
Emitter-Base Voltage	V_{EBO}	7.0			Vdc
Collector Current - Continuous	I_C	7.0			Adc
Base Current - Continuous	I_B	2.0			Adc
Total Power Dissipation @ $T_C=100^\circ\text{C}$	P_D	15			Watt
Thermal Resistance (Junction to Case)	θ_{J-C}	5.0			$^\circ\text{C/W}$
Junction Temperature	T_J	-65 to +175			$^\circ\text{C}$
Storage Temperature	T_{stg}	-65 to +200			$^\circ\text{C}$

4
NPN SWITCHING TRANSISTORS

ELECTRICAL CHARACTERISTICS (T = 25°C unless otherwise specified)

CHARACTERISTIC		SYMBOL	MIN	TYP	MAX	UNIT
----------------	--	--------	-----	-----	-----	------

OFF CHARACTERISTICS

Collector-Base Voltage ($I_C=1.0\text{mA}$)	XGSQ5030 XGSQ5035 XGSQ5040	BV_{CBO}	350 400 450			Vdc
Collector-Emitter Voltage ($I_C=50\text{mA}$)	XGSQ5030 XGSQ5035 XGSQ5040	BV_{CEO}	300 350 400			Vdc
Emitter-Base Voltage ($I_E=1.0\text{mA}$)		BV_{EBO}	7.0			Vdc
Collector Cutoff Current ($V_{CB}=80\%$ Rated V_{CB})	XGSQ5030 XGSQ5035 XGSQ5040	I_{CBO}			250 250 250	μA
Emitter Cutoff Current ($V_{EB}=5.0\text{V}$)		I_{EBO}			50	μA
Collector Cutoff Current ($V_{CE}=80\%$ Rated V_{CE})	XGSQ5030 XGSQ5035 XGSQ5040	I_{CEO}			500 500 500	μA

ON CHARACTERISTICS

DC Current Gain ($V_{CE}=5.0\text{V}$, $I_C=5.0\text{A}$)		h_{FE}^*	10			
Collector Saturation Voltage ($I_C=5.0\text{A}$, $I_B=1.0\text{A}$)		$V_{CE}(\text{sat})^*$			0.8	Vdc
Base Saturation Voltage ($I_C=5.0\text{A}$, $I_B=1.0\text{A}$)		$V_{BE}(\text{sat})^*$			1.3	Vdc

DYNAMIC CHARACTERISTICS

Small Signal Current Gain ($V_{CE}=10\text{V}$, $I_C=0.5\text{A}$, $f=10\text{MHz}$)		$ h_{fe} $	2.5			
Collector Base Capacitance ($V_{CB}=10\text{V}$, $f=1.0\text{MHz}$)		C_{ob}			250	pF
Turn-on Time ($V_{CC}=250\text{V}$, $I_C=5.0\text{A}$, $I_{B1}=1.0\text{A}$, $I_{B2}=1.0\text{A}$)		t_{on}			0.5	μs
Storage Time ($V_{CC}=250\text{V}$, $I_C=5.0\text{A}$, $I_{B1}=1.0\text{A}$, $I_{B2}=1.0\text{A}$)		t_s			1.25	μs
Fall Time ($V_{CC}=250\text{V}$, $I_C=5.0\text{A}$, $I_{B1}=1.0\text{A}$, $I_{B2}=1.0\text{A}$)		t_f			0.4	μs

*Pulse measurement conditions: Length = 300 μs , Duty Cycle $\leq 2\%$.



**GENERAL
SEMICONDUCTOR
INDUSTRIES, INC.**

C²R

**XGSQ7530
XGSQ7535
XGSQ7540**

NPN SWITCHING POWER TRANSISTORS

This unique series utilizes General Semiconductor Industries' C²R process (patent applied for) which describes a manufacturing technology that provides surface stabilization for high voltage operation and enhances long term reliability.

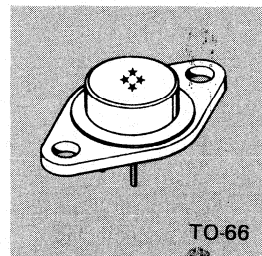

TO-66

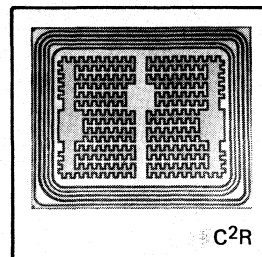

C²R

MAXIMUM RATINGS

RATINGS	SYMBOL	XGSQ7530	XGSQ7535	XGSQ7540	UNIT
Collector-Base Voltage	V_{CBO}	350	400	450	Vdc
Collector-Emitter Voltage	V_{CEO}	300	350	400	Vdc
Emitter-Base Voltage	V_{EBO}	7			Vdc
Collector Current - Continuous	I_C	10			Adc
Base Current - Continuous	I_B	5			Adc
Total Power Dissipation @ $T_C=100^\circ\text{C}$	P_D	25			Watt
Thermal Resistance (Junction to Case)	θ_{J-C}	3			$^\circ\text{C/W}$
Thermal Resistance (Junction to Ambient)	θ_{J-A}	50			$^\circ\text{C/W}$
Junction Temperature	T_J	-65 to +175			$^\circ\text{C}$
Storage Temperature	T_{stg}	-65 to +200			$^\circ\text{C}$

4

NPN SWITCHING
TRANSISTORS

ELECTRICAL CHARACTERISTICS (T = 25°C unless otherwise specified)

CHARACTERISTIC	SYMBOL	MIN	TYP	MAX	UNIT
----------------	--------	-----	-----	-----	------

OFF CHARACTERISTICS

Collector-Base Voltage ($I_C=1.0\text{mA}$)	XGSQ7530 XGSQ7535 XGSQ7540	BV_{CBO}	350 400 450		Vdc
Collector-Emitter Voltage ($I_C=50\text{mA}$)	XGSQ7530 XGSQ7535 XGSQ7540	BV_{CEO}	300 350 400		Vdc
Emitter-Base Voltage ($I_E=1.0\text{mA}$)		BV_{EBO}	7.0		Vdc
Emitter Cutoff Current ($V_{EB}=5\text{V}$)		I_{EBO}		40	μA
Collector Cutoff Current ($V_{CE}=300\text{V}$, $V_{EB}=-1.5\text{V}$, $T_C=150^\circ\text{C}$) XGSQ7530 ($V_{CE}=350\text{V}$, $V_{EB}=-1.5\text{V}$, $T_C=150^\circ\text{C}$) XGSQ7535 ($V_{CE}=400\text{V}$, $V_{EB}=-1.5\text{V}$, $T_C=150^\circ\text{C}$) XGSQ7540		I_{CEX}		3 3 3	mA
Collector Cutoff Current ($V_{CB}=280\text{V}$) XGSQ7530 ($V_{CB}=320\text{V}$) XGSQ7535 ($V_{CB}=360\text{V}$) XGSQ7540		I_{CBO}		200 200 200	μA
Collector Cutoff Current ($V_{CE}=240\text{V}$) XGSQ7530 ($V_{CE}=280\text{V}$) XGSQ7535 ($V_{CE}=320\text{V}$) XGSQ7540		I_{CEO}		500 500 500	μA

ON CHARACTERISTICS

DC Current Gain ($V_{CE}=5\text{V}$, $I_C=7.5\text{A}$)	h_{FE}^*	10			
DC Current Gain ($V_{CE}=2\text{V}$, $I_C=5.0\text{A}$)	h_{FE}^*	10			
Collector Saturation Voltage ($I_C=7.5\text{A}$, $I_B=1.5\text{A}$)	$V_{CE}(\text{sat})^*$			0.7	Vdc
Base Saturation Voltage ($I_C=7.5\text{A}$, $I_B=1.5\text{A}$)	$V_{BE}(\text{sat})^*$			1.3	Vdc

DYNAMIC CHARACTERISTICS

Small Signal Current Gain ($V_{CE}=10\text{V}$, $I_C=1\text{A}$, $f=10\text{MHz}$)	$ h_{fe} $	3.0			
Collector Base Capacitance ($V_{CB}=10\text{V}$, $f=1.0\text{MHz}$)	C_{ob}			150	pF
Delay Time ($V_{CC}=100\text{V}$, $I_C=7.5\text{A}$, $I_{B1}=1.5\text{A}$, $I_{B2}=1.5\text{A}$)	t_d			0.05	μs
Rise Time ($V_{CC}=100\text{V}$, $I_C=7.5\text{A}$, $I_{B1}=1.5\text{A}$, $I_{B2}=1.5\text{A}$)	t_r			0.35	μs
Storage Time ($V_{CC}=100\text{V}$, $I_C=7.5\text{A}$, $I_{B1}=1.5\text{A}$, $I_{B2}=1.5\text{A}$)	t_s			0.75	μs
Fall Time ($V_{CC}=100\text{V}$, $I_C=7.5\text{A}$, $I_{B1}=1.5\text{A}$, $I_{B2}=1.5\text{A}$)	t_f			0.175	μs

*Pulse measurement conditions: Length = 300 μs , Duty Cycle $\leq 2\%$.

GENERAL SEMICONDUCTOR INDUSTRIES, INC.

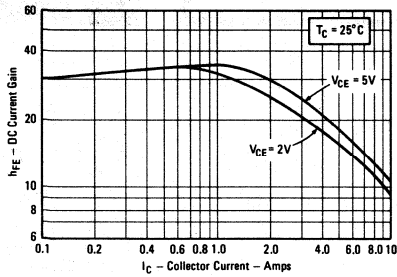

FIGURE 1 - Typical DC Current Gain

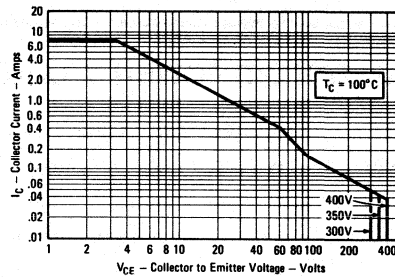

FIGURE 5 - Safe Operating Area

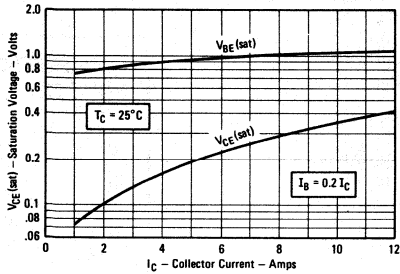

FIGURE 2 - Typical Saturation Voltage

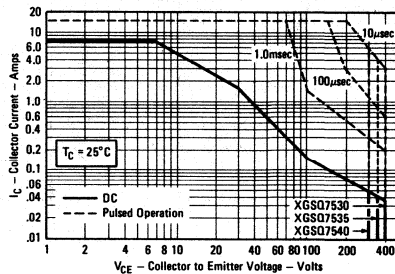

FIGURE 6 - Forward Biased Safe Operating Area

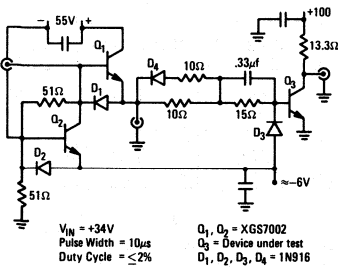

FIGURE 3 - Pulse Measurement Circuit

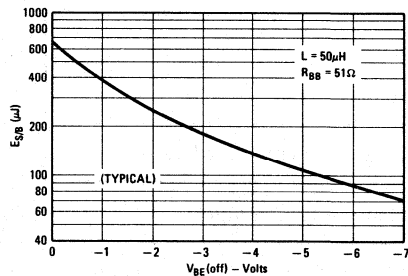

FIGURE 7 - E_s/g Curve

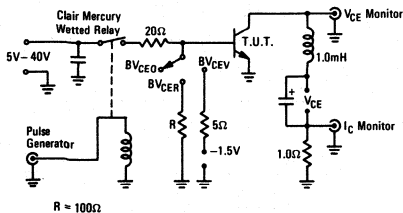
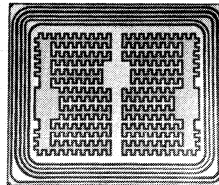

FIGURE 4 - Sustaining Voltage Circuit



This unique series utilizes General Semiconductor Industries' C^2R process (patent applied for) which describes a manufacturing technology that provides surface stabilization for high voltage operation and enhances long term reliability.

4
NPN SWITCHING TRANSISTORS



GENERAL SEMICONDUCTOR INDUSTRIES, INC.

2001 West Tenth Place, Tempe, Arizona 85281 • 602 968 3101 • TWX910-950 1942
Mailing Address: P.O. Box 3078



**GENERAL
SEMICONDUCTOR
INDUSTRIES, INC.**

C²R

**XGSR3030
XGSR3035
XGSR3040**

NPN SWITCHING POWER TRANSISTORS

This unique series utilizes General Semiconductor Industries' C²R process (patent applied for) which describes a manufacturing technology that provides surface stabilization for high voltage operation and enhances long term reliability.

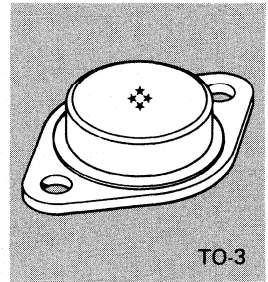

TO-3

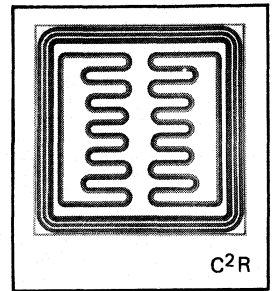

C²R

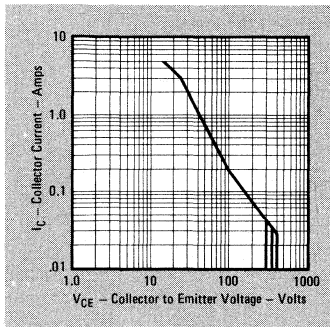

DC Forward Biased Safe Operating Area

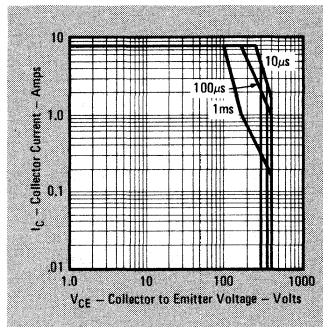

Pulsed Forward Biased Safe Operating Area

MAXIMUM RATINGS

RATINGS	SYMBOL	XGSR3030	XGSR3035	XGSR3040	UNIT
Collector-Base Voltage	V_{CBO}	350	400	450	Vdc
Collector-Emitter Voltage	V_{CEO}	300	350	400	Vdc
Emitter-Base Voltage	V_{EBO}	7.0			Vdc
Collector Current - Continuous	I_C	5.0			Adc
Base Current - Continuous	I_B	1.0			Adc
Total Power Dissipation @ $T_C=100^\circ\text{C}$	P_D	75			Watt
Thermal Resistance (Junction to Case)	θ_{J-C}	1.0			$^\circ\text{C/W}$
Junction Temperature	T_J	-65 to +175			$^\circ\text{C}$
Storage Temperature	T_{stg}	-65 to +200			$^\circ\text{C}$

ELECTRICAL CHARACTERISTICS (T = 25°C unless otherwise specified)

CHARACTERISTIC	SYMBOL	MIN	TYP	MAX	UNIT
----------------	--------	-----	-----	-----	------

OFF CHARACTERISTICS

Collector-Base Voltage ($I_C=1.0\text{mA}$)	XGSR3030 XGSR3035 XGSR3040	BV_{CBO}	350 400 450		Vdc
Collector-Emitter Voltage ($I_C=50\text{mA}$)	XGSR3030 XGSR3035 XGSR3040	BV_{CEO}	300 350 400		Vdc
Emitter-Base Voltage ($I_E=1.0\text{mA}$)		BV_{EBO}	7.0		Vdc
Collector Cutoff Current ($V_{CB}=80\%$ Rated V_{CB})	XGSR3030 XGSR3035 XGSR3040	I_{CBO}		250 250 250	μA
Emitter Cutoff Current ($V_{EB}=5.0\text{V}$)		I_{EBO}		50	μA
Collector Cutoff Current ($V_{CE}=80\%$ Rated V_{CE})	XGSR3030 XGSR3035 XGSR3040	I_{CEO}		500 500 500	μA

ON CHARACTERISTICS

DC Current Gain ($V_{CE}=5.0\text{V}$, $I_C=3.0\text{A}$)		h_{FE}^*	10		
Collector Saturation Voltage ($I_C=3.0\text{A}$, $I_B=0.6\text{A}$)		$V_{CE}(\text{sat})^*$		0.8	Vdc
Base Saturation Voltage ($I_C=3.0\text{A}$, $I_B=0.6\text{A}$)		$V_{BE}(\text{sat})^*$		1.3	Vdc

DYNAMIC CHARACTERISTICS

Small Signal Current Gain ($V_{CE}=10\text{V}$, $I_C=0.5\text{A}$, $f=10\text{MHz}$)		$ h_{fe} $	2.5		
Collector Base Capacitance ($V_{CB}=10\text{V}$, $f=1.0\text{MHz}$)		C_{ob}		250	pF
Turn-on Time ($V_{CC}=250\text{V}$, $I_C=3\text{A}$, $I_{B1}=0.6\text{A}$, $I_{B2}=0.6\text{A}$)		t_{on}		0.2	μs
Storage Time ($V_{CC}=250\text{V}$, $I_C=3\text{A}$, $I_{B1}=0.6\text{A}$, $I_{B2}=0.6\text{A}$)		t_s		2.0	μs
Fall Time ($V_{CC}=250\text{V}$, $I_C=3\text{A}$, $I_{B1}=0.6\text{A}$, $I_{B2}=0.6\text{A}$)		t_f		0.35	μs

*Pulse measurement conditions: Length = 300 μs , Duty Cycle $\leq 2\%$.



**GENERAL
SEMICONDUCTOR
INDUSTRIES, INC.**

**C²R
XGSR5030
XGSR5035
XGSR5040**

NPN SWITCHING POWER TRANSISTORS

This unique series utilizes General Semiconductor Industries' C²R process (patent applied for) which describes a manufacturing technology that provides surface stabilization for high voltage operation and enhances long term reliability.

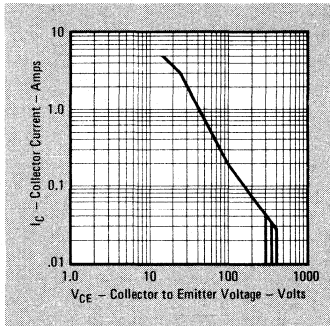

DC Forward Biased Safe Operating Area

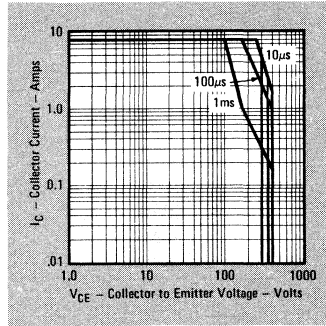

Pulsed Forward Biased Safe Operating Area

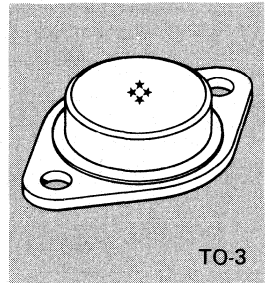

TO-3

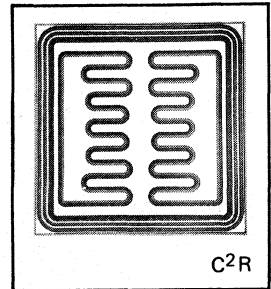

C²R

MAXIMUM RATINGS

RATINGS	SYMBOL	XGSR5030	XGSR5035	XGSR5040	UNIT
Collector-Base Voltage	V_{CBO}	350	400	450	Vdc
Collector-Emitter Voltage	V_{CEO}	300	350	400	Vdc
Emitter-Base Voltage	V_{EBO}	8.0			Vdc
Collector Current - Continuous	I_C	7.0			Adc
Base Current - Continuous	I_B	2.0			Adc
Total Power Dissipation @ $T_C=100^\circ\text{C}$	P_D	75			Watt
Thermal Resistance (Junction to Case)	θ_{J-C}	1.0			$^\circ\text{C}/\text{W}$
Junction Temperature	T_J	-65 to +175			$^\circ\text{C}$
Storage Temperature	T_{stg}	-65 to +200			$^\circ\text{C}$

ELECTRICAL CHARACTERISTICS (T = 25°C unless otherwise specified)

CHARACTERISTIC		SYMBOL	MIN	TYP	MAX	UNIT
----------------	--	--------	-----	-----	-----	------

OFF CHARACTERISTICS

Collector-Base Voltage ($I_C=1.0mA$)	XGSR5030 XGSR5035 XGSR5040	BV_{CBO}	350 400 450			Vdc
Collector-Emitter Voltage ($I_C=50mA$)	XGSR5030 XGSR5035 XGSR5040	BV_{CEO}	300 350 400			Vdc
Emitter-Base Voltage ($I_E=1.0mA$)		BV_{EBO}	7.0			Vdc
Collector Cutoff Current ($V_{CB}=80\%$ Rated V_{CB})	XGSR5030 XGSR5035 XGSR5040	I_{CBO}			250 250 250	μA
Emitter Cutoff Current ($V_{EB}=5V$)		I_{EBO}			50	μA
Collector Cutoff Current ($V_{CE}=80\%$ Rated V_{CE})	XGSR5030 XGSR5035 XGSR5040	I_{CEO}			500 500 500	μA

ON CHARACTERISTICS

DC Current Gain ($V_{CE}=5.0V$, $I_C=5.0A$)		h_{FE}^*	10			
Collector Saturation Voltage ($I_C=5A$, $I_B=1A$)		$V_{CE(sat)}^*$			0.8	Vdc
Base Saturation Voltage ($I_C=5A$, $I_B=1A$)		$V_{BE(sat)}^*$			1.3	Vdc

DYNAMIC CHARACTERISTICS

Small Signal Current Gain ($V_{CE}=10V$, $I_C=0.5A$, $f=10MHz$)		$ h_{fe} $	2.5			
Collector Base Capacitance ($V_{CB}=10V$, $f=1MHz$)		C_{ob}			250	pF
Turn-on Time ($V_{CC}=2.50V$, $I_C=5A$, $I_{B1}=1A$, $I_{B2}=1A$)		t_{on}			0.5	μs
Storage Time ($V_{CC}=2.50V$, $I_C=5A$, $I_{B1}=1A$, $I_{B2}=1A$)		t_s			1.75	μs
Fall Time ($V_{CC}=2.50V$, $I_C=5A$, $I_{B1}=1A$, $I_{B2}=1A$)		t_f			0.45	μs

*Pulse measurement conditions: Length = 300 μs , Duty Cycle $\leq 2\%$.



**GENERAL
SEMICONDUCTOR
INDUSTRIES, INC.**

C²R

**XGSR7530
XGSR7535
XGSR7540**

NPN SWITCHING POWER TRANSISTORS

This unique series utilizes General Semiconductor Industries' C²R process (patent applied for) which describes a manufacturing technology that provides surface stabilization for high voltage operation and enhances long term reliability.

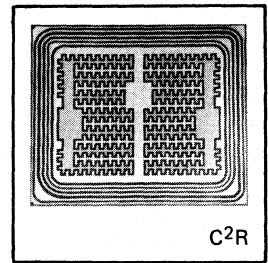
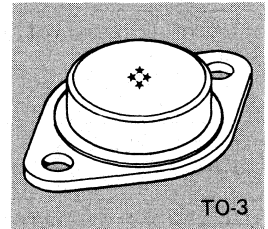

MAXIMUM RATINGS

RATINGS	SYMBOL	XGSR7530	XGSR7535	XGSR7540	UNIT
Collector-Base Voltage	V_{CBO}	350	400	450	Vdc
Collector-Emitter Voltage	V_{CEO}	300	350	400	Vdc
Emitter-Base Voltage	V_{EBO}	7.0			Vdc
Collector Current - Continuous	I_C	10			Adc
Base Current - Continuous	I_B	5			Adc
Total Power Dissipation @ $T_C=100^\circ\text{C}$	P_D	50			Watt
Thermal Resistance (Junction to Case)	θ_{J-C}	1.5			$^\circ\text{C}/\text{W}$
Thermal Resistance (Junction to Ambient)	θ_{J-A}	30			$^\circ\text{C}/\text{W}$
Junction Temperature	T_J	-65 to +175			$^\circ\text{C}$
Storage Temperature	T_{stg}	-65 to +200			$^\circ\text{C}$

ELECTRICAL CHARACTERISTICS (T = 25°C unless otherwise specified)

CHARACTERISTIC	SYMBOL	MIN	TYP	MAX	UNIT
----------------	--------	-----	-----	-----	------

OFF CHARACTERISTICS

Collector-Base Voltage ($I_C=1.0\text{mA}$)	XGSR7530 XGSR7535 XGSR7540	BV_{CBO}	350 400 450		Vdc
Collector-Emitter Voltage ($I_C=50\text{mA}$)	XGSR7530 XGSR7535 XGSR7540	BV_{CEO}	300 350 400		Vdc
Emitter-Base Voltage ($I_E=1.0\text{mA}$)		BV_{EBO}	7.0		Vdc
Emitter Cutoff Current ($V_{EB}=5.0\text{V}$)		I_{EBO}		40	μA
Collector Cutoff Current ($V_{CE}=300\text{V}$, $V_{EB}=-1.5\text{V}$, $T_c=150^\circ\text{C}$) XGSR7530 ($V_{CE}=350\text{V}$, $V_{EB}=-1.5\text{V}$, $T_c=150^\circ\text{C}$) XGSR7535 ($V_{CE}=400\text{V}$, $V_{EB}=-1.5\text{V}$, $T_c=150^\circ\text{C}$) XGSR7540		I_{CEX}		3 3 3	mA mA
Collector Cutoff Current ($V_{CB}=280\text{V}$) XGSR7530 ($V_{CB}=320\text{V}$) XGSR7535 ($V_{CB}=360\text{V}$) XGSR7540		I_{CBO}		200 200 200	μA
Collector Cutoff Current ($V_{CE}=240\text{V}$) XGSR7530 ($V_{CE}=280\text{V}$) XGSR7535 ($V_{CE}=320\text{V}$) XGSR7540		I_{CEO}		500 500 500	μA

ON CHARACTERISTICS

DC Current Gain ($V_{CE}=5\text{V}$, $I_C=7.5\text{A}$)	h_{FE}^*	10			
DC Current Gain ($V_{CE}=2\text{V}$, $I_C=5.0\text{A}$)	h_{FE}^*	10			
Collector Saturation Voltage ($I_C=7.5\text{A}$, $I_B=1.5\text{A}$)	$V_{CE(sat)}^*$			0.6	Vdc
Base Saturation Voltage ($I_C=7.5\text{A}$, $I_B=1.5\text{A}$)	$V_{BE(sat)}^*$			1.25	Vdc

DYNAMIC CHARACTERISTICS

Small Signal Current Gain ($V_{CE}=10\text{V}$, $I_C=1\text{A}$, $f=10\text{MHz}$)	$ h_{fe} $	3			
Collector Base Capacitance ($V_{CB}=10\text{V}$, $I_C=0$, $f=1\text{MHz}$)	C_{ob}			150	pF
Delay Time ($V_{CC}=100\text{V}$, $I_C=7.5\text{A}$, $I_{B1}=1.5\text{A}$, $I_{B2}=1.5\text{A}$)	t_d			0.05	μs
Rise Time ($V_{CC}=100\text{V}$, $I_C=7.5\text{A}$, $I_{B1}=1.5\text{A}$, $I_{B2}=1.5\text{A}$)	t_r			0.35	μs
Storage Time ($V_{CC}=100\text{V}$, $I_C=7.5\text{A}$, $I_{B1}=1.5\text{A}$, $I_{B2}=1.5\text{A}$)	t_s			0.75	μs
Fall Time ($V_{CC}=100\text{V}$, $I_C=7.5\text{A}$, $I_{B1}=1.5\text{A}$, $I_{B2}=1.5\text{A}$)	t_f			0.175	μs

*Pulse measurement conditions: Length = 300 μs , Duty Cycle $\leq 2\%$.

4

NPN SWITCHING
TRANSISTORS



**GENERAL
SEMICONDUCTOR
INDUSTRIES, INC.**

C²R

**XGSR10030
XGSR10035
XGSR10040**

NPN SWITCHING POWER TRANSISTORS

This unique series utilizes General Semiconductor Industries' C²R process (patent applied for) which describes a manufacturing technology that provides surface stabilization for high voltage operation and enhances long term reliability.

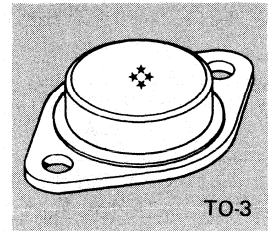

TO-3

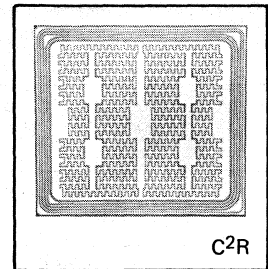

C²R

MAXIMUM RATINGS

RATINGS	SYMBOL	XGSR10030	XGSR10035	XGSR10040	UNIT
Collector-Base Voltage	V_{CBO}	350	400	450	Vdc
Collector-Emitter Voltage	V_{CEO}	300	350	400	Vdc
Emitter-Base Voltage	V_{EBO}	7.0			Vdc
Collector Current - Continuous	I_C	15			Adc
Collector Current - Peak	I_C	30			Adc
Base Current - Continuous	I_B	5.0			Adc
Total Power Dissipation @ $T_C=100^\circ\text{C}$	P_D	75			Watt
Thermal Resistance (Junction to Case)	θ_{J-C}	1.0			$^\circ\text{C}/\text{W}$
Junction Temperature	T_J	-65 to +175			$^\circ\text{C}$
Storage Temperature	T_{stg}	-65 to +200			$^\circ\text{C}$

4

**NPN SWITCHING
TRANSISTORS**

ELECTRICAL CHARACTERISTICS (T = 25°C unless otherwise specified)

CHARACTERISTIC		SYMBOL	MIN	TYP	MAX	UNIT
OFF CHARACTERISTICS						
Collector-Base Voltage ($I_C=1.0mA$)	XGSR10030 XGSR10035 XGSR10040	BV_{CBO}	350 400 450			Vdc
Collector-Emitter Voltage ($I_C=50mA$)	XGSR10030 XGSR10035 XGSR10040	BV_{CEO}	300 350 400			Vdc
Emitter-Base Voltage ($I_E=1.0mA$)		BV_{EBO}	7.0			Vdc
Collector-Emitter Breakdown Voltage ($I_C=50mA$, $V_{BE} = -1.5V$ (FIG. 4))	XGSR10030 XGSR10035 XGSR10040	BV_{CEX}	350 400 450			Vdc
Collector-Emitter Breakdown Voltage ($I_C=50mA$, $R=100\Omega$ (FIG. 4))	XGSR10030 XGSR10035 XGSR10040	BV_{CER}	325 375 425			Vdc
Collector Cutoff Current ($V_{CB}=80\% V_{CB}$ Rated)	XGSR10030 XGSR10035 XGSR10040	I_{CBO}			500 500 500	μA
Emitter Cutoff Current ($V_{EB}=5.0V$)		I_{EBO}			100	μA
Collector Cutoff Current ($V_{CE}=80\% V_{CE}$ Rated)	XGSR10030 XGSR10035 XGSR10040	I_{CEO}			1.0 1.0 1.0	mA

ON CHARACTERISTICS

DC Current Gain ($V_{CE}=5.0V$, $I_C=10A$)	XGSR10030 XGSR10035 XGSR10040	h_{FE}^*	15 10 10			
Collector Saturation Voltage ($I_C=10A$, $I_B=2.0A$)		$V_{CE(sat)}^*$			0.8	Vdc
Base Saturation Voltage ($I_C=10A$, $I_B=2.0A$)		$V_{BE(sat)}^*$			1.3	Vdc

DYNAMIC CHARACTERISTICS

Small Signal Current Gain ($V_{CE}=10V$, $I_C=1.0A$, $f=10MHz$)		$ h_{fe} $	2.5			
Collector Base Capacitance ($V_{CB}=10V$, $f=1MHz$)		C_{ob}			350	pF
Turn-on Time ($V_{CC}=100V$, $I_C=10A$, $I_{B1}=1.0A$, $I_{B2}=1.0A$)		t_{on}			0.2	μs
Storage Time ($V_{CC}=100V$, $I_C=10A$, $I_{B1}=1.0A$, $I_{B2}=1.0A$ (FIG. 3))		t_s			1.5	μs
Fall Time ($V_{CC}=100V$, $I_C=10A$, $I_{B1}=1.0A$, $I_{B2}=1.0A$)		t_f			0.5	μs

*Pulse measurement conditions: Length = 300 μs , Duty Cycle \leq 2%.

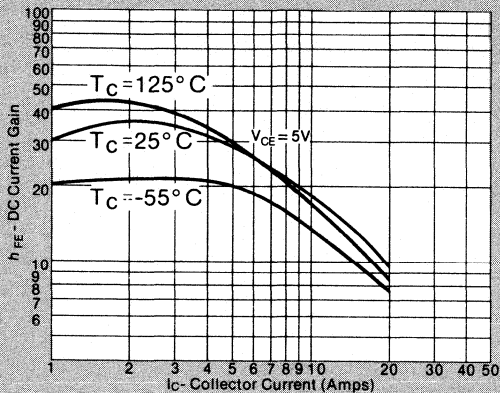

Figure 1— TYPICAL DC CURRENT GAIN

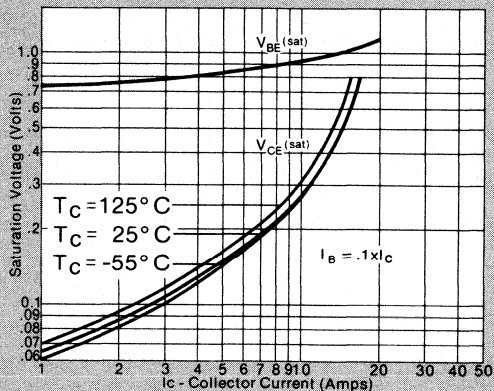

Figure 2— TYPICAL SATURATION VOLTAGE

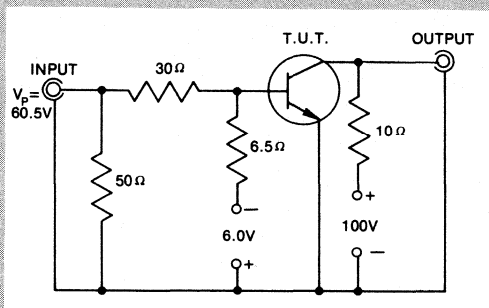

Figure 3— PULSE TEST CIRCUIT

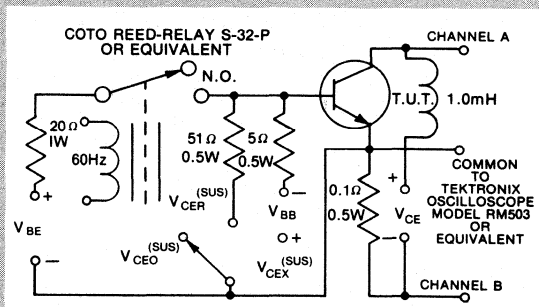

Figure 4— SUSTAINING VOLTAGE CIRCUIT

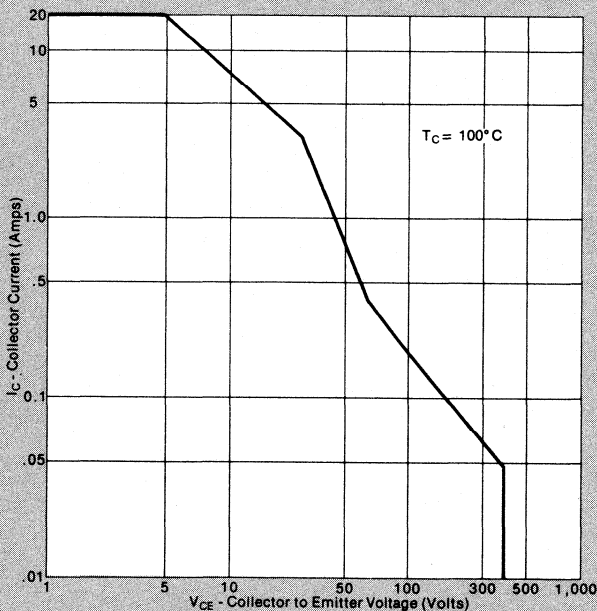

Figure 5— SAFE OPERATING AREA



GENERAL
SEMICONDUCTOR
INDUSTRIES, INC.

C²R

XGSR50020

NPN SWITCHING POWER TRANSISTORS

This unique device utilizes General Semiconductor Industries' C²R process (patent applied for) which describes a manufacturing technology that provides surface stabilization for high voltage operation and enhances long term reliability.

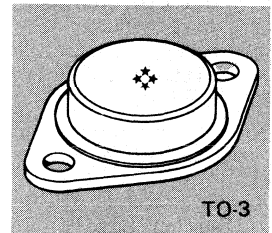

TO-3

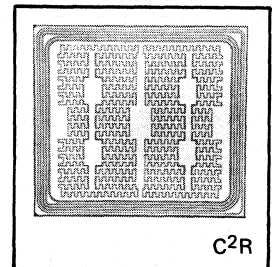

C²R

MAXIMUM RATINGS

RATINGS	SYMBOL	XGSR50020	UNIT
Collector-Base Voltage	V_{CBO}	250	Vdc
Collector-Emitter Voltage	V_{CEO}	200	Vdc
Emitter-Base Voltage	V_{EBO}	8.0	Vdc
Collector Current - Continuous	I_C	30	Adc
Base Current - Continuous	I_B	10	Adc
Total Power Dissipation @ $T_C=100^\circ\text{C}$	P_D	100	Watt
Thermal Resistance (Junction to Case)	θ_{J-C}	0.75	$^\circ\text{C/W}$
Junction Temperature	T_J	-65 to +175	$^\circ\text{C}$
Storage Temperature	T_{stg}	-65 to +200	$^\circ\text{C}$

4

NPN SWITCHING
TRANSISTORS

ELECTRICAL CHARACTERISTICS (T = 25°C unless otherwise specified)

CHARACTERISTIC	SYMBOL	MIN	TYP	MAX	UNIT
----------------	--------	-----	-----	-----	------

OFF CHARACTERISTICS

Collector-Base Voltage ($I_C=1.0\text{mA}$)	BV_{CBO}	250			Vdc
Collector-Emitter Voltage ($I_C=50\text{mA}$)	BV_{CEO}	200			Vdc
Emitter-Base Voltage ($I_E=1.0\text{mA}$)	BV_{EBO}	8.0			Vdc
Collector Cutoff Current ($V_{CB}=200\text{V}$)	I_{CBO}			500	μA
Emitter Cutoff Current ($V_{EB}=5.0\text{V}$)	I_{EBO}			100	μA
Collector Cutoff Current ($V_{CE}=160\text{V}$)	I_{CEO}			1.0	mA

ON CHARACTERISTICS

DC Current Gain ($V_{CE}=2\text{V}$, $I_C=20\text{A}$)	h_{FE}^*	15		50	
DC Current Gain ($V_{CE}=5.0\text{V}$, $I_C=50\text{A}$)	h_{FE}^*	8			
DC Current Gain ($V_{CE}=2.0\text{V}$, $I_C=50\text{A}$)	h_{FE}^*	6			
Collector Saturation Voltage ($I_C=20\text{A}$, $I_B=2.0\text{A}$)	$V_{CE}(\text{sat})^*$			1.0	Vdc
Collector Saturation Voltage ($I_C=50\text{A}$, $I_B=10\text{A}$)	$V_{CE}(\text{sat})^*$			2.0	Vdc
Base Saturation Voltage ($I_C=20\text{A}$, $I_B=2.0\text{A}$)	$V_{BE}(\text{sat})^*$			1.4	Vdc
Base Saturation Voltage ($I_C=50\text{A}$, $I_B=10\text{A}$)	$V_{BE}(\text{sat})^*$			2.5	Vdc

DYNAMIC CHARACTERISTICS

Small Signal Current Gain ($V_{CE}=10\text{V}$, $I_C=1.0\text{A}$, $f=10\text{MHz}$)	$ h_{fe} $	3.0			
Collector Base Capacitance $V_{CB}=10\text{V}$, $I_C=0$, $f=1\text{MHz}$)	C_{ob}			350	pF
Turn-on Time ($V_{CC}=100\text{V}$, $I_C=15\text{A}$, $I_{B1}=3.0\text{A}$, $I_{B2}=3.0\text{A}$)	t_{on}			0.1	μs
Storage Time ($V_{CC}=100\text{V}$, $I_C=15\text{A}$, $I_{B1}=3.0\text{A}$, $I_{B2}=3.0\text{A}$)	t_s			0.7	μs
Fall Time ($V_{CC}=100\text{V}$, $I_C=15\text{A}$, $I_{B1}=3.0\text{A}$, $I_{B2}=3.0\text{A}$)	t_f			0.2	μs

*Pulse measurement conditions: Length = 300 μs , Duty Cycle $\leq 2\%$.

ENVIRONMENTAL FACILITIES AND EQUIPMENT

I. Life Tests and Power-Age Capabilities

- A. General Semiconductor Industries, has complete facilities to provide life tests and power-age on all devices which they manufacture.
- a. High temperature storage life testing up to 200°C.
 - b. Voltage temperature stress tests at both ambient and elevated conditions.
 - c. Free air operating life. Test capability in excess of 5000 positions for power transistors, and 15,000 positions for power diodes.
 - d. Case temperature operating life test capabilities for power dissipation levels up to 200 watts.
 - e. Intermittent operating life tests at various cycles and power levels.

II. Environmental Test Capabilities

TEST	CAPABILITY
Acceleration, Sustained (Centrifuge)	50 – 20,000g (Standard)
Altitude (Barometric Pressure, Reduced)	450,000 ft. Simulated Altitude with TA=25°C Capability
Dew Point	-65°C to 150°C
Moisture Resistance	0°C to 175°C, 40% to 100% RH
Radiographic Inspection (X-Ray)	Resolution to 0.001 inch, 150kV – 5mA
Salt Atmosphere/Spray	25°C to 71°C, up to 20% Salt Solution by Weight
Seal – Gross Leak	1 X 10 ⁻⁵ atm cc/sec, Fluorocarbons, Mineral Oils, Ethylene Glycol, Hydrostatic Pressure; 0 – 100psig
Symbolization (Resistance to Solvents)	
Shock (Mechanical)	Pulse Shape – Approximately Half-sine 500 – 1500g @ 0.5 – 1.0 msec
Solderability	Up to 280°C
Temperature Cycling	-75°C to 200°C
Terminal Strength (Lead Integrity)	Lead Fatigue, Tension, Stud Torque, Terminal Torque
Thermal Shock	-65°C to 200°C
Vibration, Fatigue	60 Hz, 5 – 20g
Vibration, Variable	5 – 2000 Hz as Limited by 1 inch DA and 60 inches/second Velocity; 0 – 20g (Standard)

III. Military Test Standard Capabilities

TEST CATEGORY	MIL-STD-202	MIL-STD-750
Altitude	All Conditions	All Conditions
Dew Point		All Conditions
Moisture Resistance	All Conditions	All Conditions
Resistance to Solvents (Symbolization)	All Conditions	All Conditions
Salt Atmosphere	All Conditions	All Conditions
Seal, Gross Leak	Method 112B, Conditions A, B, & D	Method 1071, Conditions C, D, E, & F
Seal, Fine Leak	Only Method 112B, Condition C, Procedure IIIA	Method 1071, Condition G
Solderability	All Conditions	All Conditions
Soldering Heat	All Conditions	All Conditions
Temperature Cycling	All Conditions Except: Method 107, Conditions D & E	
Terminal Strength (Lead Integrity)	All Conditions	All Conditions
Thermal Shock (Glass Strain)	All Conditions	All Conditions
Acceleration, Sustained (Centrifuge)	All Conditions	All Conditions
Shock (Mechanical)	Method 213B, Conditions D, E, & F	All Conditions
Vibration, Fatigue	All Conditions	All Conditions
Vibration, Noise		All Conditions
Vibration, Variable Frequency	All Conditions	All Conditions
X-Ray	All Conditions	All Conditions

5
MILITARY QUALIFIED
TYPES AND HIGH-REL
FACILITIES

JAN/JANTX(V) AVAILABILITY

ZENER DIODES MIL-S-19500

/114		/124		/358	
1N2805B	1N2823B	1N2970B	1N2991B	1N3305B	1N3327B
1N2806B	1N2824B	1N2971B	1N2992B	1N3306B	1N3328B
1N2807B	1N2825B	1N2972B	1N2993B	1N3307B	1N3330B
1N2808B	1N2826B	1N2973B	1N2995B	1N3308B	1N3332B
1N2809B	1N2827B	1N2974B	1N2997B	1N3309B	1N3334B
1N2810B	1N2829B	1N2975B	1N2999B	1N3310B	1N3335B
1N2811B	1N2831B	1N2976B	1N3000B	1N3311B	1N3336B
1N2813B	1N2832B	1N2977B	1N3001B	1N3312B	1N3337B
1N2814B	1N2833B	1N2979B	1N3002B	1N3314B	1N3338B
1N2816B	1N2834B	1N2980B	1N3003B	1N3315B	1N3339B
1N2818B	1N2835B	1N2982B	1N3004B	1N3317B	1N3340B
1N2819B	1N2836B	1N2984B	1N3005B	1N3319B	1N3342B
1N2820B	1N2837B	1N2985B		1N3320B	1N3343B
1N2822B		1N2986B		1N3321B	1N3344B
		1N2988B		1N3323B	1N3346B
		1N2989B		1N3324B	1N3347B
		1N2990B		1N3325B	1N3349B
				1N3326B	1N3350B

TRANSZORBES MIL-S-19500

/434	/500		/507	
1N5555	1N5907	1N5647A	1N6036A	1N6055A
1N5556	1N5629A	1N5648A	1N6037A	1N6056A
1N5557	1N5630A	1N5649A	1N6038A	1N6057A
1N5558	1N5631A	1N5650A	1N6039A	1N6058A
	1N5632A	1N5651A	1N6040A	1N6059A
	1N5633A	1N5652A	1N6041A	1N6060A
	1N5634A	1N5653A	1N6042A	1N6061A
	1N5635A	1N5654A	1N6043A	1N6062A
	1N5636A	1N5655A	1N6044A	1N6063A
	1N5637A	1N5656A	1N6045A	1N6064A
	1N5638A	1N5657A	1N6046A	1N6065A
	1N5639A	1N5658A	1N6047A	1N6066A
	1N5640A	1N5659A	1N6048A	1N6067A
	1N5641A	1N5660A	1N6049A	1N6068A
	1N5642A	1N5661A	1N6050A	1N6069A
	1N5643A	1N5662A	1N6051A	1N6070A
	1N5644A	1N5663A	1N6052A	1N6071A
	1N5645A	1N5664A	1N6053A	1N6072A
	1N5646A	1N5665A	1N6054A	

TC REFERENCE DIODES MIL-S-19500

/156	/157	/159
1N935B	1N941B	1N821
1N937B	1N943B	1N823
1N938B	1N944B	1N825
		1N827
		1N829

TRANSISTORS MIL-S-19500

/349	/393	/394
2N3506	2N3418	2N4150
2N3507	2N3419	
	2N3420	
	2N3421	

CASE OUTLINES — DIODES

Case 1

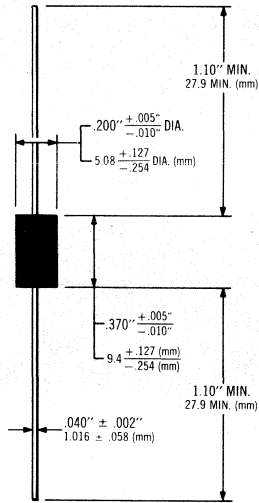

Case 2

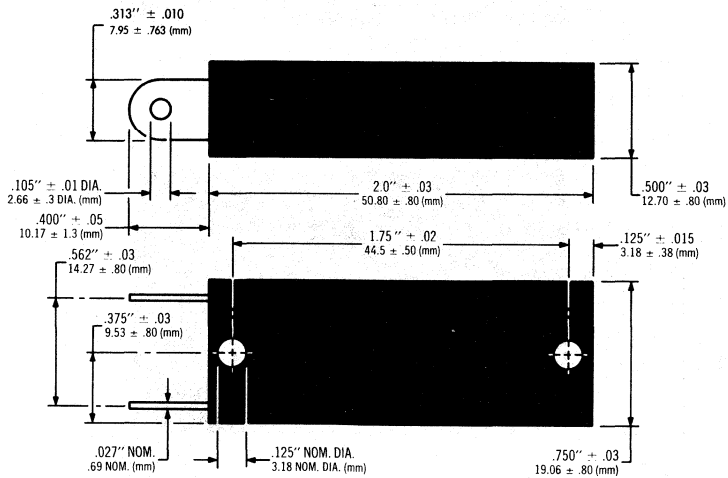

CASE OUTLINES — DIODES

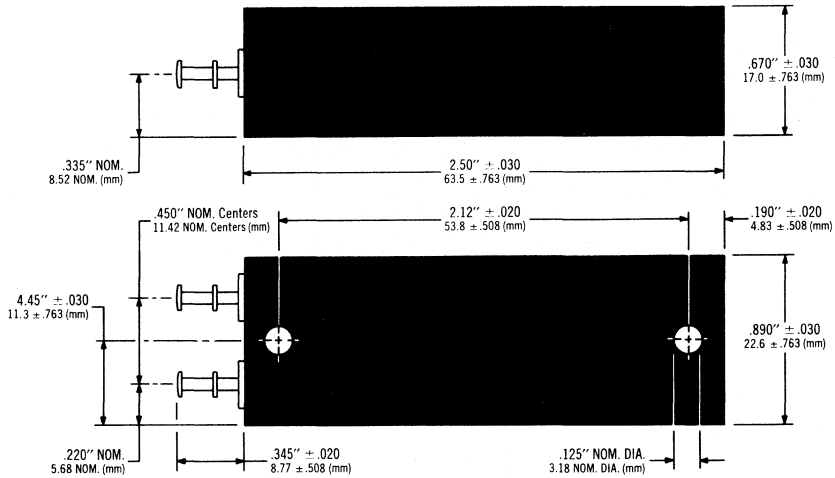

Case 3

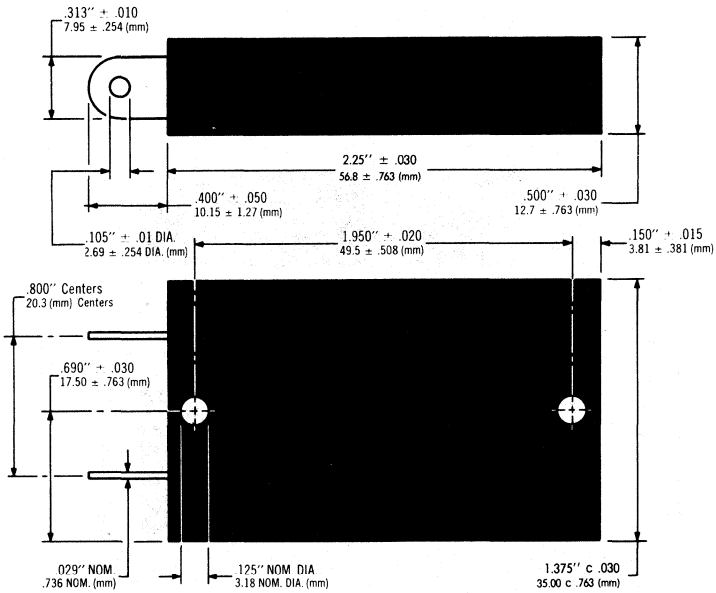

Case 4

CASE OUTLINES — DIODES

Case 5

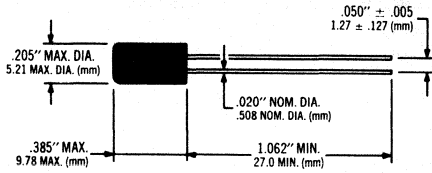

Case 6

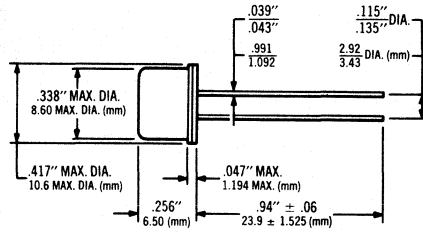

Case 7

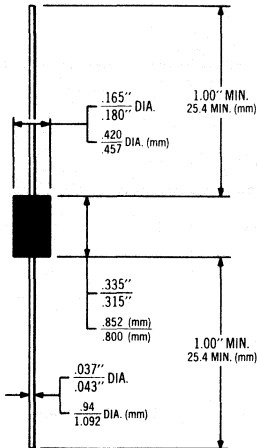

Case 8

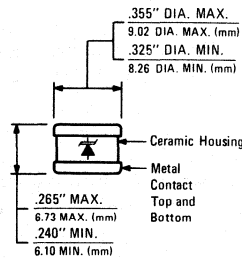

Case 9

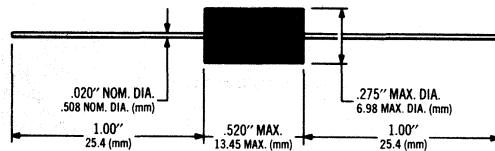

Case 10

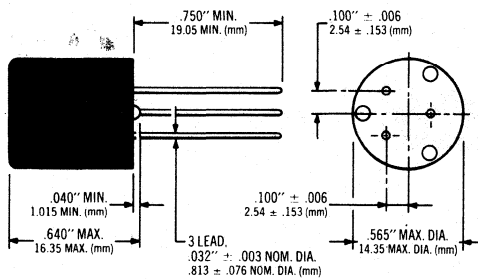

Case 11

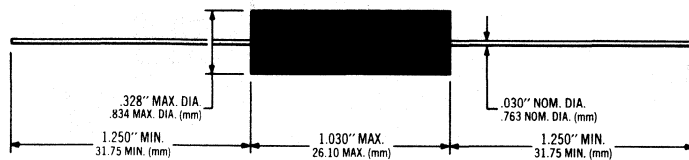

6 CASE OUTLINES

CASE OUTLINES — DIODES

Case 12

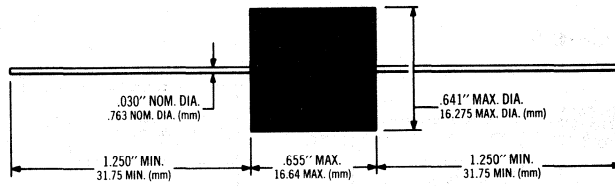

Case 14

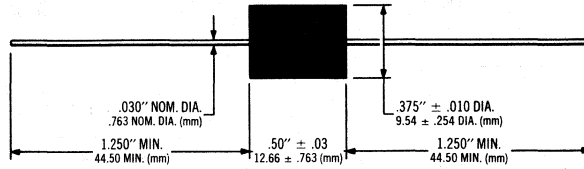

Case 15

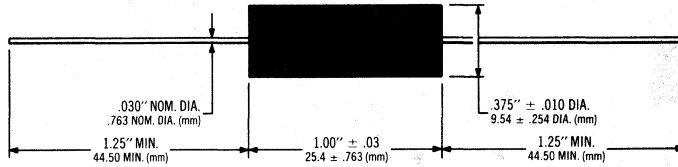

Case 16

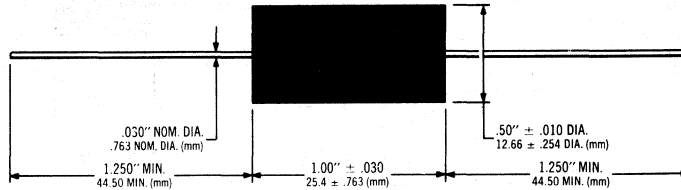

Case 17

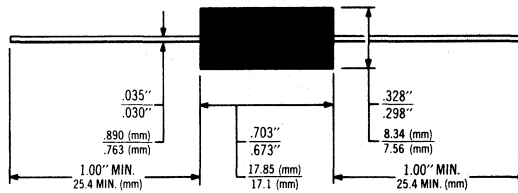

Case 18

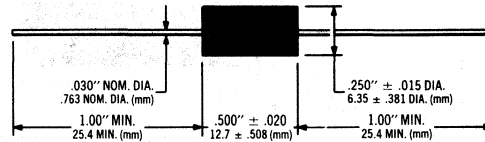

CASE OUTLINES — DIODES

Case 19

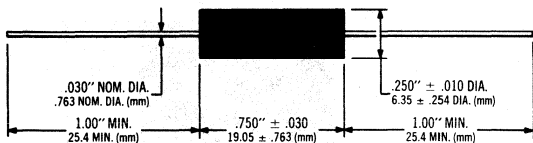

Case 20

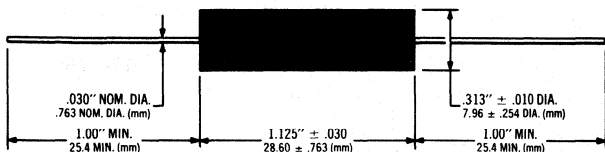

Case 21

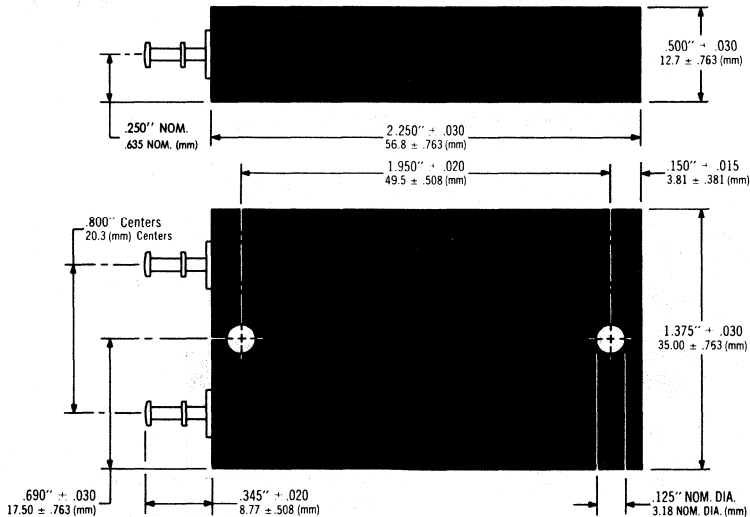
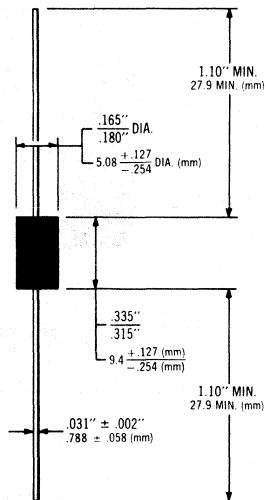

Case 22

6
CASE
OUTLINES

CASE OUTLINES — DIODES

Case 23

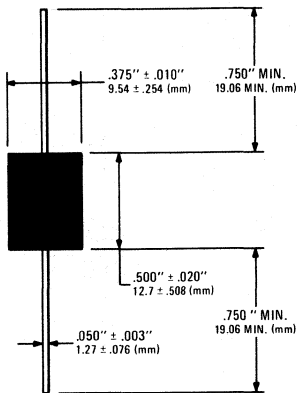

Case 24

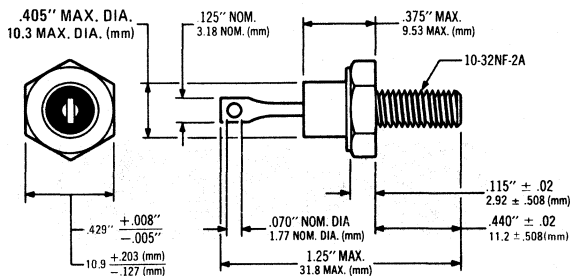
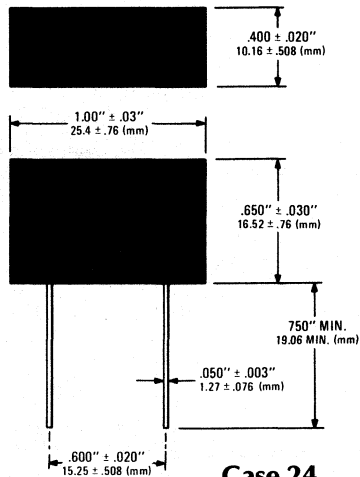

Case DO — 4,
10 — 32

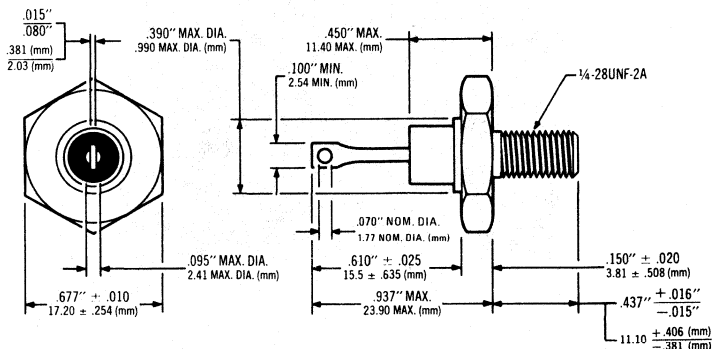

Case DO — 5, 1/4—28

CASE OUTLINES — DIODES

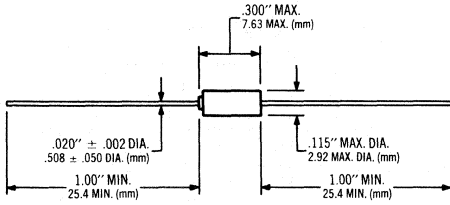

Case DO—7

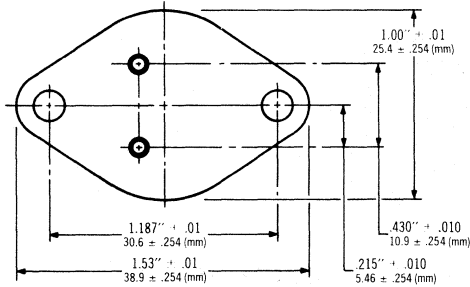
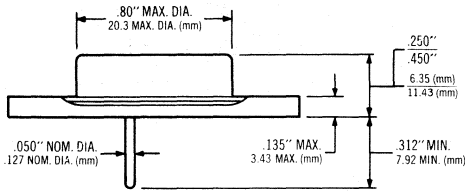

Case TO—3 (.050" Pin Dia.)

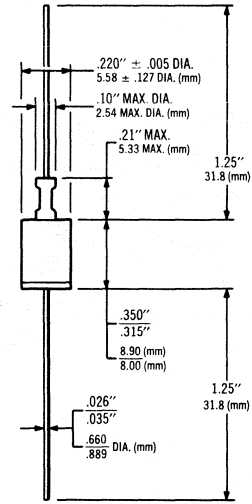

Case DO—13

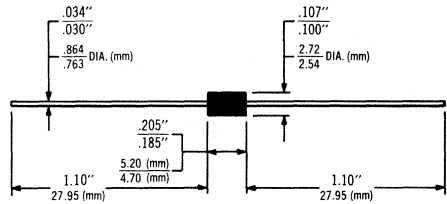

Case DO — 41

CASE OUTLINES — TRANSISTORS

Case TO-3

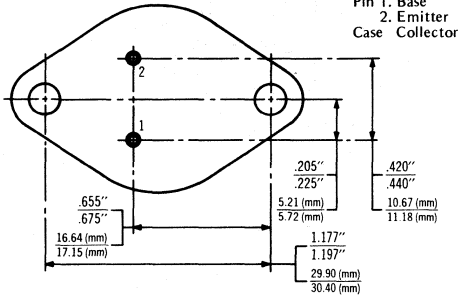
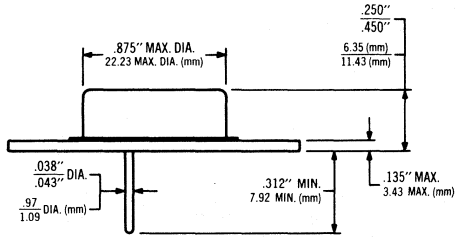

Case TO-3 MODIFIED (.050" Pin Dia.)

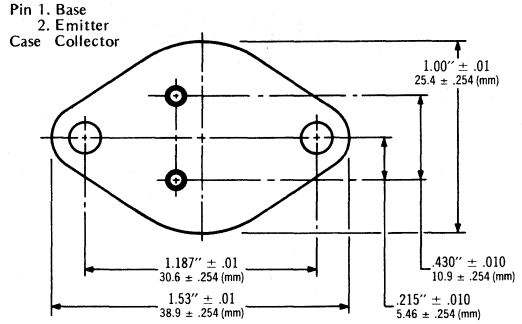
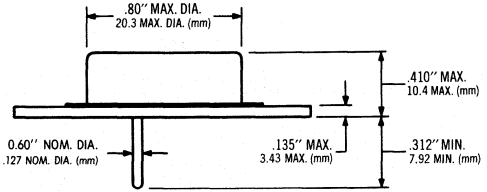

Case TO-5

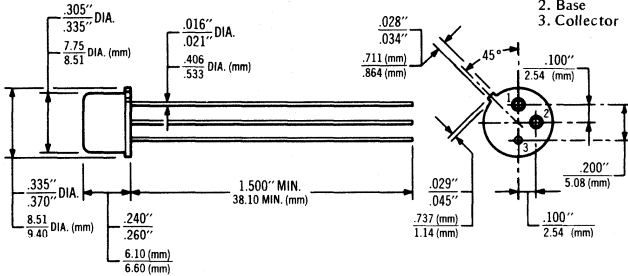

Pin 1. Emitter
2. Base
3. Collector

Case TO-5S

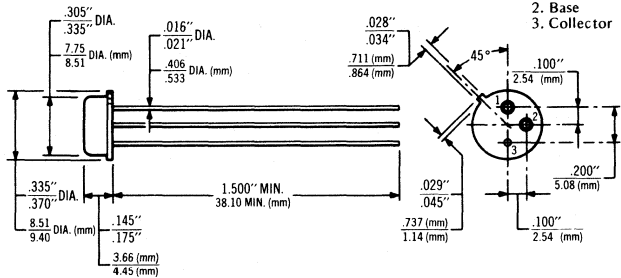

Pin 1. Emitter
2. Base
3. Collector

CASE OUTLINES – TRANSISTORS

Case TO-39

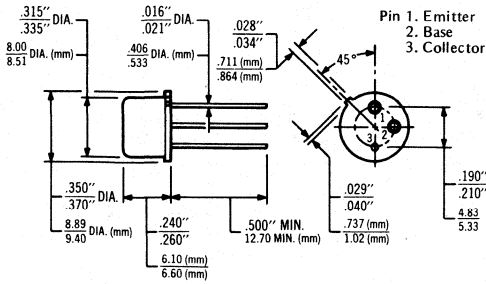

Case TO-59

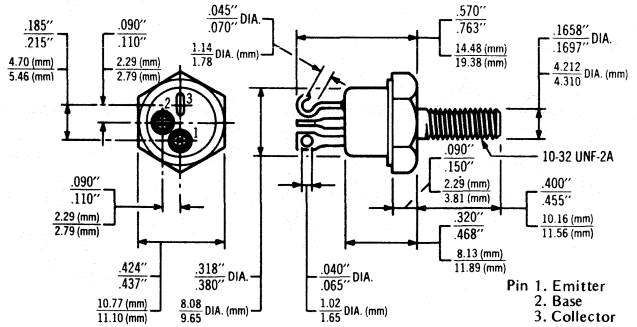

Case TO-61

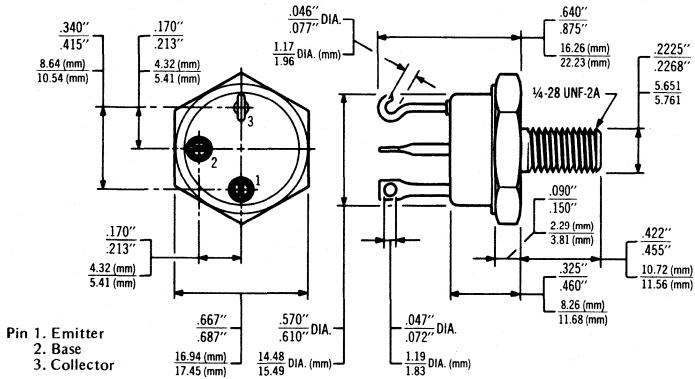

Case TO-63

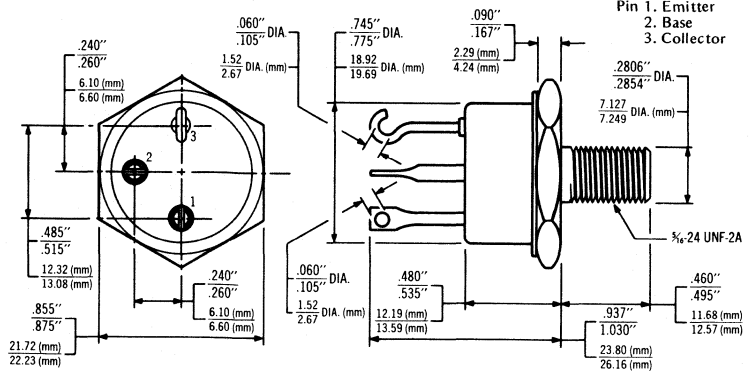

NOTES

NOTES

NOTES

NOTES

NOTES

NOTES

REGIONAL SALES OFFICES

EASTERN REGIONAL OFFICE

P.O. Box A101
Wantagh, NY 11793
TEL: 516-785-6803
TWX: 510-224-6672

MID-WESTERN REGIONAL OFFICE

P.O. Box 59353
Chicago, IL 60659
TEL: 312-647-7660
TWX: 910-221-2455

WESTERN REGIONAL OFFICE

P.O. Box 3034
Granada Hills, CA 91344
TEL: 213-780-2990
TWX: 910-495-2017

REPRESENTATIVES

ALABAMA

REMCO
3322 S. Memorial Parkway S.W.
Suite 65
Huntsville, AL 35801
TEL: 205-883-9260
TWX: 810-726-2123

ARIZONA

QUATRA, INC.
1801 S. Jen Tilly
Suite C-14
Tempe, AZ 85281
TEL: 602-894-2808

ARKANSAS

OELER & MENELAIDES
558 South Central Expressway
Suite 276
Richardson, TX 75080
TEL: 214-234-6334
TWX: 910-867-4745

CALIFORNIA — NORTHERN

KOTTMEIER ASSOCIATES, INC.
P.O. Box 519
San Carlos, CA 94070
TEL: 415-592-8333
TWX: 910-376-4397

CALIFORNIA — SOUTHERN

REED ELECTRONIC MARKETING
3772 Katella Avenue
P.O. Box 206
Los Alamitos, CA 90720
TEL: 714-821-9600
TWX: 910-341-7295

CALIFORNIA — SAN DIEGO

REED ELECTRONIC MARKETING
P.O. Box 964
Del Mar, CA 92014
TEL: 714-452-1456
TWX: 910-322-1131

COLORADO

QUATRA, INC.
2275 E. Arapahoe Road
Littleton, CO 80122
TEL: 303-795-3187
TWX: 910-935-0874

CONNECTICUT

DATCOM
1 Evergreen Avenue
Hamden, CT 06518
TEL: 203-288-7005

DELAWARE

BGR ASSOCIATES
6th Floor
2500 Office Center
Willow Grove, PA 19090
TEL: 215-657-3301
TWX: 510-665-5685

FLORIDA — FORT LAUDERDALE

DYNE-A-MARK CORPORATION
1001 N.W. 62nd Street
Suite 107
Fort Lauderdale, FL 33309
TEL: 305-771-6501
TWX: 510-956-9872

FLORIDA — CLEARWATER

DYNE-A-MARK CORPORATION
405 South Aurora
Clearwater, FL 33515
TEL: 813-441-4702
TWX: 810-866-0438

FLORIDA — ORLANDO

DYNE-A-MARK CORPORATION
P.O. Box 33
Maitland, FL 32751
TEL: 305-831-2097
TWX: 810-853-5039

FLORIDA — PALM BAY

DYNE-A-MARK CORPORATION
P.O. Box 339
Palm Bay, FL 32905
TEL: 305-831-2097

GEORGIA

REMCO
Suite 110
3100 Proctor Square
Duluth, GA 30136
TEL: 404-476-1730

IDAHO

ELECTRONIC SOURCES, INC.
1406-140th Pl. N.E.
Bellevue, WA 98005
TEL: 206-643-0400
TWX: 910-443-2530

ILLINOIS — NORTHERN

BALHORN & ROESER, INC.
1758 Taft Avenue
Berkeley, IL 60162
TEL: 312-449-3900
TWX: 910-234-3901

ILLINOIS — SOUTHERN

TECHNICAL SALES ASSOC., INC.
P.O. Box 10907
St. Louis, MO 63135
TEL: 314-725-5361
TWX: 910-760-1629

INDIANA — INDIANAPOLIS

GIESTING & ASSOCIATES, INC.
6315 Copper Court
Indianapolis, IN 46227
TEL: 317-787-0276

INDIANA — FT. WAYNE

GIESTING & ASSOCIATES, INC.
4407 DeRome Dr.
Ft. Wayne, IN 46815
TEL: 219-486-1912

IOWA

BALHORN & ROESER, INC.
206 Collins Road N.E.
Suite P
Cedar Rapids, IA 52402
TEL: 319-377-4814

KANSAS

TECHNICAL SALES ASSOC. INC.
P.O. Box 5232
Shawnee Mission, KS 62215
TEL: 913-888-3330
TWX: 910-749-6657

KANSAS

TECHNICAL SALES ASSOCIATES
1445 Sierra Drive
P.O. Box 12662
Wichita, KS 67277
TEL: 316-945-5501

KENTUCKY

GIESTING & ASSOCIATES, INC.
3274 Donnybrook Lane
Cincinnati, OH 45239
TEL: 513-521-8800
TLX: 914-283 (GIESTING CIN.)

LOUISIANA

OELER & MENELAIDES
558 S. Central Expressway
Suite 276
Richardson, TX 75080
TEL: 214-234-6334
TWX: 910-867-4745

MAINE

DATCOM
55 Moody Street
Waltham, MA 02154
TEL: 617-891-4600
TLX: 92-3462 (DATCOM WHA)

MARYLAND

COULBOURN DE GREIF, INC.
5205 East Drive
Baltimore, MD 21227
TEL: 301-247-4646
TWX: 710-236-9011

MASSACHUSETTS

DATCOM
55 Moody Street
Waltham, MA 02154
TEL: 617-891-4600
TLX: 92-3462 (DATCOM WHA)

REPRESENTATIVES

MICHIGAN — NORTHVILLE
GIESTING & ASSOCIATES, INC.
149 Mary Alexander Court
Northville, MI 48167
TEL: 313-348-3811

MICHIGAN — COLOMA
GIESTING & ASSOCIATES, INC.
5654 Wendzel Dr.
Coloma, MI 49038
TEL: 616-468-4200

MINNESOTA
PROFESSIONAL SALES FOR INDUSTRY
720 W. 94th St.
Minneapolis, MN 55420
TEL: 612-884-1777
TWX: 910-576-3483

MISSISSIPPI
REMCO
3322 S. Memorial Parkway
Suite 65
Huntsville, AL 35801
TEL: 205-883-9260
TWX: 810-726-2123

MISSOURI
TECHNICAL SALES ASSOCIATES
P.O. Box 10907
St. Louis, MO 63135
TEL: 314-725-5361
TWX: 910-760-1629

MONTANA
ELECTRONIC SOURCES, INC.
1406-140th Pl. N.E.
Bellevue, WA 98005
TEL: 206-643-0400
TWX: 910-443-2530

NEBRASKA
TECHNICAL SALES ASSOCIATES INC.
P.O. Box 5232
Shawnee Mission, KS 62215
TEL: 913-888-3330
TWX: 910-749-6657

NEVADA (RENO ONLY)
KOTTMEIER ASSOCIATES
P.O. Box 519
San Carlos, CA 94070
TEL: 415-592-8333
TWX: 910-376-4397

NEVADA
GENERAL SEMICONDUCTOR
INDUSTRIES, INC.
2001 W. 10th Place
Tempe, AZ 85281
TEL: 602-968-3101
TWX: 910-950-1942

NEW HAMPSHIRE
DATCOM
55 Moody Street
Waltham, MA 02154
TEL: 617-891-4600
TLX: 92-3462 (DATCOM WHA)

NEW JERSEY — NORTHERN
J-SQUARE MARKETING, INC.
1250 A Shames Drive
Westbury, NY 11590
TEL: 516-997-6210
TWX: 510-222-1048

NEW JERSEY — SOUTHERN
BGR ASSOCIATES
6th Floor, 2500 Office Center
Willow Grove, PA 19090
TEL: 215-657-3301
TWX: 510-665-5685

NEW MEXICO
RONTEK
P.O. Box 14815
Albuquerque, NM 87111
TEL: 505-299-4124

NEW YORK — METROPOLITAN
J-SQUARE MARKETING, INC.
1250 A Shames Drive
Westbury, NY 11590
TEL: 516-997-6210
TWX: 510-222-1048

NEW YORK — UPSTATE
BOB DEAN, INC.
710 W. Clinton Street
Ithaca, NY 14850
TEL: 607-272-2187
TWX: 510-255-5876

NORTH CAROLINA
REMCO
11720 Man O' War Trail
Raleigh, NC 27612
TEL: 919-787-1461

NORTH DAKOTA
PROFESSIONAL SALES FOR INDUSTRY
720 W. 94th St.
Minneapolis, MN 55420
TEL: 612-884-1777
TWX: 910-576-3483

OHIO — CINCINNATI
GIESTING & ASSOCIATES, INC.
3274 Donnybrook Lane
Cincinnati, OH 45239
TEL: 513-521-8800
TLX: 214-283 (GIESTING CIN.)

OHIO — DAYTON
GIESTING & ASSOCIATES, INC.
5512 Autumn Hills Dr. Apt. #9
Westbrook Village
Dayton, OH 45426
TEL: 513-293-4044

OHIO — GALION
GIESTING & ASSOCIATES, INC.
570 S. State Circle
Galion, OH 44833
TEL: 419-468-3737

OKLAHOMA
OELER & MENELAIDES
558 South Central Expressway
Suite 276
Richardson, TX 75080
TEL: 214-234-6334
TWX: 910-867-4745

OREGON
ELECTRONIC SOURCES INC.
5319 SW Westgate Dr.
Portland, OR 97221
TEL: 503-292-0701
TWX: 910-464-6105

PENNSYLVANIA — EASTERN
BGR ASSOCIATES
6th Floor, 2500 Office Center
Willow Grove, PA 19090
TEL: 215-657-3301
TWX: 510-665-5685

PENNSYLVANIA — WESTERN
GIESTING & ASSOCIATES, INC.
3274 Donnybrook Lane
Cincinnati, OH 45239
TEL: 513-521-8800
TLX: 214-283 (GIESTING CIN.)

RHODE ISLAND
DATCOM
55 Moody Street
Waltham, MA 02154
TEL: 617-891-4600
TLX: 92-3462 (DATCOM WHA)

SOUTH CAROLINA
REMCO
11720 Man O' War Trail
Raleigh, NC 27612
TEL: 919-787-1461

SOUTH DAKOTA
PROFESSIONAL SALES FOR INDUSTRY
720 W. 94th St.
Minneapolis, MN 55420
TEL: 612-884-1777
TWX: 910-576-3483

TENNESSEE
REMCO
3322 S. Memorial Parkway
Suite 65
Huntsville, AL 35801
TEL: 205-883-9260
TWX: 810-726-2123

TEXAS — EL PASO
RONTEK
P.O. Box 14815
Albuquerque, NM 87111
TEL: 505-299-4124

TEXAS — RICHARDSON
OELER & MENELAIDES
558 South Central Expressway
Suite 276
Richardson, TX 75080
TEL: 214-234-6334
TWX: 910-867-4745

TEXAS — HOUSTON
OELER & MENELAIDES
9119 S. Gessner Suite 201
Houston, TX 77074
TEL: 713-772-0730
TWX: 910-881-7032

REPRESENTATIVES

UTAH

QUATRA, INC.
2275 E. Arapahoe Rd.
Littleton, CO 80122
TEL: 303-795-3187
TWX: 910-935-0874

VERMONT

DATCOM
55 Moody Street
Waltham, MA 02154
TEL: 617-891-4600
TLX: 92-3462 (DATCOM WHA)

VIRGINIA

COULBOURN DE GREIF, INC.
5205 East Drive
Baltimore, MD 21227
TEL: 301-247-4646
TWX: 710-236-9011

VIRGINIA — SOUTHERN

COULBOURN DE GREIF, INC.
1616 Inglewood Dr.
Charlottesville, VA 22901
TEL: 804-977-0031

WASHINGTON

ELECTRONIC SOURCES, INC.
1406-140th Pl. N.E.
Bellevue, WA 98005
TEL: 206-643-0400
TWX: 910-443-2530

WEST VIRGINIA

GIESTING & ASSOCIATES, INC.
3274 Donnybrook Lane
Cincinnati, OH 45239
TEL: 513-521-8800
TLX: 214-283 (GIESTING CIN.)

WISCONSIN — NORTHERN

PROFESSIONAL SALES FOR INDUSTRY
720 W. 94th St.
Minneapolis, MN 55420
TEL: 612-884-1777
TWX: 910-576-3483

WISCONSIN — SOUTHERN

BALHORN & ROESER, INC.
1758 Taft Avenue
Berkeley, IL 60162
TEL: 312-449-3900
TWX: 910-234-3901

WYOMING

QUATRA, INC.
2275 E. Arapahoe Rd.
Littleton, CO 80122
TEL: 303-795-3187
TWX: 910-935-0874

DISTRICT OF COLUMBIA

COULBOURN DE GREIF, INC.
5205 East Drive
Baltimore, MD 21227
TEL: 301-247-4646
TWX: 710-236-9011

DISTRIBUTORS

ARIZONA

KACHINA ELECTRONIC DISTRIBUTORS
1425 N. 27th Lane
Phoenix, AZ 85009
TEL: 602-269-6201

CETEC MOLTRONICS

3617 N. 35th Avenue
Phoenix, AZ 85017
TEL: 602-272-7951
TWX: 910-951-1512

CALIFORNIA — NORTHERN

BELL INDUSTRIES
1161 N. Fair Oaks
Sunnyvale, CA 94086
TEL: 408-734-8570
TWX: 910-339-9378

CETEC MOLTRONICS

721 Charcot St.
San Jose, CA 95131
TEL: 408-263-7373
TWX: 910-338-0288

WESTERN MICROTECHNOLOGY

10040 Bubb Rd.
Cupertino, CA 95014
TEL: 408-725-1660
TWX: 910-338-0013

CALIFORNIA — SOUTHERN

BELL INDUSTRIES
306 E. Alondra Blvd.
Gardena, CA 90248
TEL: 213-515-1800
TWX: 910-346-6336

CETEC MOLTRONICS

5610 E. Imperial Hwy.
Southgate, Ca 90280
TEL: 213-773-6521
TWX: 910-583-1947

CETEC MOLTRONICS

4617 Ruffner St.
Suite 101
San Diego, CA 92111
TEL: 714-278-5020
TWX: 910-335-2015

JACO ELECTRONICS

20600 Plummer St.
Chatsworth, CA 91311
TEL: 213-998-2200
TWX: 910-494-4828

ZEUS COMPONENTS

1130 Hawk Circle
Anaheim, Ca 92807
TEL: 714-632-6880
TWX: 910-591-1691

COLORADO

BELL INDUSTRIES
8155 W. 48th Ave.
Wheatridge, CO 80033
TEL: 303-424-1985
TWX: 910-938-0393

CONNECTICUT

HARVEY ELECTRONICS
112 Main Street
Norwalk, CT 06851
TEL: 203-853-1515
TWX: 710-468-3373

FLORIDA

DIPLOMAT / SOUTHLAND, INC.
6890 N.W. 20th Ave.
Ft. Lauderdale, FL 33309
TEL: 305-971-7160

DIPLOMAT / SOUTHLAND, INC.

2120 Calumet
Clearwater, FL 33515
TEL: 813-443-4514
TWX: 810-866-0436

HAMMOND ELECTRONICS INDUSTRIES

1230 W. Central Blvd.
Orlando, FL 32805
TEL: 305-849-6060
TWX: 810-850-4121

ILLINOIS

BELL INDUSTRIES
3422 W. Touhy Ave.
Chicago, Illinois 60645
TEL: 312-982-9210
TWX: 910-223-4519

OHM ELECTRONICS

P.O. Box 368
746 Vermont
Palatine, IL 60067
TEL: 312-359-5500
TWX: 910-693-4802

IOWA

DEECO, INC.
2500 16th Ave. S.W.
Cedar Rapids, IA 52406
TEL: 319-365-7551
TWX: 910-525-1332

KANSAS

LCOMP
2211 Riverfront Drive
Kansas City, MO 64120
TEL: 816-221-2400
TWX: 910-771-3148

LCOMP

330 Cleveland
Wichita, KS 67214
TEL: 316-265-8501

MARYLAND

TECHNICO, INC.
9051 Red Branch Rd.
Columbia, MD 21045
TEL: 301-995-1995
TWX: 710-862-1907

DISTRIBUTORS

MASSACHUSETTS

CAVALIER COMPONENTS, INC.
220 Reservoir Street
Needham Heights, MA 02194
TEL: 617-449-3112

HARVEY ELECTRONICS
44 Hartwell Ave.
Lexington, MA 02173
TEL: 617-861-9200
TWX: 710-326-6617

ZEUS COMPONENTS
16 Adams St.
Burlington, MA 01803
TEL: 617-273-0750
TWX: 710-332-0716

MICHIGAN

REPTRON ELEC., INC.
34403 Glendale Rd.
Livonia, MI 48150
TEL: 313-525-2700

ARROW ELECTRONICS
3810 Varsity Dr.
Ann Arbor, MI 48104
TEL: 313-971-8220
TWX: 810-223-6020

MINNESOTA

STARK ELECTRONICS
401 Royalston Ave. North
Minneapolis, MN 55405
TEL: 612-332-1325
TWX: 910-576-2714

MISSOURI

LCOMP
2211 Riverfront Dr.
Kansas City, MO 64120
TEL: 816-221-2400
TWX: 910-771-3148

LCOMP
2550 Harley Drive
Maryland Heights, MO 63043
TEL: 314-291-6200
TWX: 910-762-0632

NEW JERSEY

HARVEY ELECTRONICS
45 Route 46
Pinebrook, NJ 07058
TEL: 201-227-1262
TWX: 710-734-4382

DIPLOMAT ELECTRONICS
490 S. Riverview Dr.
Totowa, N.J. 07512
TEL: 201-785-1830

NEW MEXICO

BELL INDUSTRIES
11728 Linn N.E.
Albuquerque, NM 87123
TEL: 505-292-2700
TWX: 910-989-0625

NEW YORK

COMPONENTS PLUS
40 Oser Ave.
Hauppauge, NY 11787
TEL: 516-231-9200
TWX: 510-227-9869

DIPLOMAT ELECTRONICS
110 Marcus Drive
Melville, NY 11747
TEL: 516-454-6400
TLX: 645-101 DipInt, Melv

HARVEY ELECTRONICS
60 Crossway Park West
Woodbury, NY 11797
TEL: 516-921-8700
TWX: 510-221-2184

KAHGAN COMPONENTS
556 Peninsula Blvd.
Hempstead, NY 11550
TEL: 516-538-2300
TWX: 510-222-4347

MONARCH COMPONENTS, INC.
66 Commack Rd.
Commack, NY 11725
TEL: 516-499-1770

ZEUS COMPONENTS
500 Executive Blvd.
Elmsford, NY 10523
TEL: 914-592-4120
TWX: 710-567-1248

NEW YORK — UPSTATE

HARVEY ELECTRONICS
P.O. Box 1208
Vestal Parkway East
Binghamton, NY 13902
TEL: 607-748-8211
TWX: 510-252-0893

HARVEY ELECTRONICS
(Rochester Area)
10 Riverton Way
West Henrietta, NY 14568
TEL: 716-334-5920
TWX: 510-253-7001

NORTH CAROLINA

HAMMOND ELECTRONICS
2923 Pacific Ave.
Greensboro, NC 27406
TEL: 919-275-6391
TWX: 510-925-1094

OHIO

ARROW ELECTRONICS, INC.
(Cleveland Area)
6238 Cochran Road
Solon, OH 44139
TEL: 216-248-3990
TWX: 810-427-9293

ARROW ELECTRONICS, INC.
10 Knollcrest Dr.
Cincinnati, OH 45237
TEL: 513-761-5432
TWX: 810-461-2670

ARROW ELECTRONICS, INC.
(Dayton Area)
3100 Plainfield Rd.
Kettering, OH 45432
TEL: 513-253-9176
TWX: 810-459-1611

PENNSYLVANIA

CENTURY ELECTRONICS
537 Foundry Rd.
Norristown, PA 19403
TEL: 215-631-5400

SOUTH CAROLINA

HAMMOND ELECTRONICS, INC.
1035 Lowndes Hill Rd.
Greenville, SC 29602
TEL: 803-233-4121
TWX: 810-281-2233

TEXAS

TEXCOMP
9119 S. Gessner
Suite 201
Houston, TX 77074
TEL: 713-772-0730
TEL: 713-995-5356
TWX: 910-881-7032

TREVINO ELECTRONICS
2874 Walnut Hill Lane
Dallas, TX 75229
TEL: 214-358-2418
TWX: 910-861-9194

UTAH

BELL INDUSTRIES
3639 West 2150 South
Salt Lake City, UT 84120
TEL: 801-972-6969
TWX: 910-925-5686

VIRGINIA

(See Maryland)

WASHINGTON

ZEPHER ELECTRONIC SALES
647 Industry Drive
Seattle, WA 98188
TEL: 206-575-0922
TWX: 910-444-2264

WISCONSIN

BELL INDUSTRIES
850 N. Elm Grove Rd.
Elm Grove, WI 53122
TEL: 414-784-0235
TWX: 910-262-1156

TAYLOR ELECTRONICS
1000 W. Donges Bay Rd.
Mequon, WI 53092
TEL: 414-241-4321
TWX: 910-262-3414

CANADIAN REPRESENTATIVES

ONTARIO

CANTEC REPRESENTATIVES, INC.
1573 La Pierriere Ave.
Ottawa, Ontario K1Z 7T3
TEL: 613-725-3704
TWX: 610-562-8967

CANTEC REPRESENTATIVES, INC.
83 Galaxy Blvd., Unit 1A
Toronto, Ontario M9W 5X6
TEL: 416-675-2460
TWX: 610-492-2655

QUEBEC

CANTEC REPRESENTATIVES, INC.
15737 Rue Pierrefonds
St. Genevieve, P.Q.
Canada H9H 1G3
TEL: 514-626-3856
TWX: 610-422-3985

CANADIAN DISTRIBUTORS

CANADA

FUTURE
1050 Baxter Rd.
Ottawa, Ontario
Canada K2C3P2
TEL: 613-820-9471

TORONTO OFFICE

FUTURE
4800 Defferin St.
Downsview, Ontario
Canada M3H558
TEL: 416-663-5563

VANCOUVER OFFICE

FUTURE
3070 Kingsway
Vancouver, BC V54R557

MONTREAL OFFICE

FUTURE
5647 Ferrier St.
Montreal, Canada H4P2K5
Quebec
TEL: 514-735-5775
TWX: 610-421-3251

ZENTRONICS

480 A. Dutton Drive
Waterloo, Ontario N2L4C6
TEL: 519-884-5700

ZENTRONICS

5010 Rue Pare
Montreal, Quebec M4P1P3
TEL: 514-735-5361
TLX: 05-827535 (Zentronics)

ZENTRONICS

1355 Meyerside Dr.
Mississauga, Ontario L5T1C9
TEL: 416-676-9000
TLX: 06-983657 (Zentronics)

ZENTRONICS

141 Catherine St.
Ottawa, Ontario K2P1C3
TEL: 613-238-6411
TLX: 053-3636 (Zentronics)

ZENTRONICS

550 Cambie Street
Vancouver, B.C. V6B2N7
TEL: 604-688-2533
TLX: 04-507787 (Zentronics)

BOWTEK ELECT.

993 W. 8th Ave.
Vancouver, B.C. V5Z1E4
TEL: 604-736-1141
TWX: 610-922-6016

INTERNATIONAL REPRESENTATIVES / DISTRIBUTORS

AUSTRIA

BURISCH Ges. m.b.H.&Co. KG
A-1215 Wien
Postfach 24
Scheydgasse 31
Austria
TEL: (222) 38 76 38
TLX: 113310 (BURIS A)

BELGIUM

MICROTRON INTERNATIONAL P.V.B.A.
Bldv. Edmond Machtenslaan 75 B17
1080 Brussels
Belgium
TEL: (2) 523 22 17
TLX: 22606 (MITRON B)

BRAZIL

TELEIMPORT / ELETRONICA LTD.
Rua Sta Ifigenia
402-8° A 10° and 01207
Sao Paulo
Brazil
TEL: (11) 221 8694
TLX: 1124888 (TLIM BR)

DENMARK

E.V. JOHANSSEN ELEKTRONIK A/S
15 Titangade
DK-2200, Copenhagen N
Denmark
TEL: (1) 83 90 22
TLX: 16522 (EVICAS DK)

ENGLAND / UNITED KINGDOM

HUNTER ELECTRONIC COMPONENTS LTD.
55 High Street
Burnham Bucks SL17JX
England
TEL: (6286) 63333
TLX: 848946 (HUNTER G)

DISTRONIC LTD. (DIST. ONLY)

50-51 Burnt Mill
Elizabeth Way, Harlow
Essex CM20 2HU
England
TEL: (279) 32947
TLX: 81387 (DSTRNC G)

FINLAND

S-W INSTRUMENTS
Karstulantie 4 00550
Helsinki 55
Finland
TEL: (0) 738 265
TLX: 12 2411 (SW1 SF)

FRANCE

COMPOSANTS ET PRODUITS ELECTRONIQUES
51, Rue de la Riviere, BP1
78420 Carrieres-Sur-Seine
France
TEL: (1) 914 61 36
TLX: 695635 (CPELEC)

INTERNATIONAL REPRESENTATIVES / DISTRIBUTORS

GERMANY

SINUS-ELECTRONIC
7100 Heilbronn
Freidrich-Durr-Str. 64
Postfach 3067
West Germany
TEL: (7131) 52077
TLX: 728453 (SIEL D)

INDIA

N.J. INTERNATIONAL CORPORATION
29/30 Ashok Chambers
Broach Street
Bombay 400 009
India
TEL: (22) 328509
TLX: 114543 (NJIC IN)

ISRAEL

RAPAC ELECTRONICS LTD.
Post Office Box 18053
Tel-Aviv 61180
Israel
TEL: (3) 47 71 15
TLX: 33528 (RAPAC IL)

ITALY

METROELETTRONICA
Viale Cirene, 18
20135 Milano
Italy
TEL: (2) 546 26 41
TLX: 312168 (METRONI I)

JAPAN

K-H ELECTRONICS CORPORATION
Komatsu Bldg., 2-3-6 Akasaka
Minato-Ku, Tokyo
Japan
TEL: (3) 584 6391
TLX: J26250 (KOMANTLS)

THE NETHERLANDS

MCA-TRONIX INTERNATIONAL B.V.
Delftweg 69
2289 Ba Rijswijk (ZH)
The Netherlands
TEL: (015) 134 940
TLX: 34150 (MCA NL)

NORWAY

HANS H. SCHIVE A/S
P.O. Box 250, Skoyen
Gustav Vigerlands Vei 5
Oslo 2
Norway
TEL: (2) 55 76 92
TLX: 19124 (SKIVE N)

SOUTH AFRICA

ELECTRONIC BUILDING ELEMENTS
P.O. Box 4609
Pretoria, 0001
Republic of South Africa
TEL: (12) 78 9221
TLX: 30181 (SA)

SPAIN

FASTRONIX
Constancia 43
Madrid 2
Spain
TEL: (1) 415 66 54
TLX: 23606 (ELICO E)

SWEDEN

SVENSK TELEINDUSTRI AB
Box 502
S. 16205 Vallingby 5
Sweden
TEL: (8) 890435
TLX: 13033 (STAIB S+)

SWITZERLAND

ELWET LTD.
CH-5430 Wettingen
Bahnhofstrasse 53
Switzerland
TEL: (56) 26 47 47
TLX: 53660 (ELWET CH)